



# Administrator's Guide for Polycom<sup>®</sup> HDX<sup>®</sup> Systems

---

## Trademark Information

Polycom®, the Polycom “Triangles” logo, and the names and marks associated with Polycom’s products are trademarks and/or service marks of Polycom, Inc., and are registered and/or common-law marks in the United States and various other countries.

Other product and corporate names may be trademarks of other companies and are used only as a fair use reference without intent to infringe.

## Patent Information

The accompanying product may be protected by one or more U.S. and foreign patents and/or pending patent applications held by Polycom, Inc.

## Customer Feedback

We are constantly working to improve the quality of our documentation, and we would appreciate your feedback. Please send email to [videodocumentation@polycom.com](mailto:videodocumentation@polycom.com).

© 2012 Polycom, Inc. All rights reserved.

Polycom, Inc.  
6001 America Center Drive  
San Jose CA 95002  
USA

No part of this document may be reproduced or transmitted in any form or by any means, electronic or mechanical, for any purpose, without the express written permission of Polycom, Inc. Under the law, reproducing includes translating into another language or format.

As between the parties, Polycom, Inc., retains title to and ownership of all proprietary rights with respect to the software contained within its products. The software is protected by United States copyright laws and international treaty provision. Therefore, you must treat the software like any other copyrighted material (e.g., a book or sound recording).

Every effort has been made to ensure that the information in this manual is accurate. Polycom, Inc., is not responsible for printing or clerical errors. Information in this document is subject to change without notice.

---

# About This Guide

The *Administrator's Guide for Polycom HDX Systems* is for administrators who need to configure, customize, manage, and troubleshoot Polycom® HDX® systems. The guide covers the following HDX systems:

- Polycom HDX 9000 series
- Polycom HDX 8000 series
- Polycom HDX 7000 series
- Polycom HDX 6000 series
- Polycom HDX 4000 series

Please read the Polycom HDX system documentation before you install or operate the system. The following related documents for Polycom HDX systems are available from [www.polycom.com/videodocumentation](http://www.polycom.com/videodocumentation):

- *Installing Software and Options for Polycom HDX Systems and Accessories*, which describes how to install Polycom HDX systems and accessories
- *User's Guide for Polycom HDX Room Systems*, *User's Guide for Polycom HDX Desktop Systems*, and *User's Guide for Polycom HDX Systems and the Polycom Touch Control*, which describe how to perform video conferencing tasks
- Setup Sheets for your optional hardware
- Release Notes
- *Integrator's Reference Manual for Polycom HDX Systems*, which provides cable information and API command descriptions
- *Regulatory Notices*, which describes safety and legal considerations for using Polycom HDX systems

For support or service, please contact your Polycom distributor or go to Polycom Support at [support.polycom.com](http://support.polycom.com).

Polycom recommends that you record the serial number and option key of your Polycom HDX system here for future reference. The serial number for the system is printed on the unit.

System Serial Number: \_\_\_\_\_

Option Key: \_\_\_\_\_





---

# Contents

## 1 Introducing the Polycom HDX Systems

Polycom HDX Systems .....	1-1
Polycom HDX 9000 Series Systems .....	1-1
Polycom HDX 8000 Series Systems .....	1-2
Polycom HDX 7000 Series Systems .....	1-2
Polycom HDX 6000 Series Systems .....	1-2
Polycom HDX 4000 Series Systems .....	1-3
Setting Up Your System Hardware .....	1-3
Positioning the System .....	1-4
Positioning the Polycom HDX 9000 Series Systems .....	1-4
Positioning the Polycom HDX 8000 Series, Polycom HDX 7000 Series, or Polycom HDX 6000 Series Systems .....	1-4
Positioning the Polycom HDX 4000 Series Systems .....	1-5
Positioning the Polycom Touch Control Device .....	1-6
Positioning the Polycom EagleEye Director .....	1-7
Powering On and Off .....	1-9
Power-On Self Test (POST) .....	1-9
Powering On the Polycom HDX 9000 Series Systems .....	1-9
Polycom HDX 9000 Series Indicator Light .....	1-10
Powering On the Polycom HDX 8000 Series, Polycom HDX 7000 Series, or Polycom HDX 6000 Series Systems .....	1-10
Polycom HDX 8000 Series, Polycom HDX 7000 Series, and Polycom HDX 6000 Series Indicator Light .....	1-11
Powering On the Polycom HDX 4000 Systems .....	1-11
Polycom HDX 4000 Systems Indicator Lights .....	1-12
Powering the Polycom HDX 4500 System On and Off .....	1-13
Polycom HDX 4500 System Indicator Lights .....	1-14
Powering On the Polycom Touch Control Device .....	1-15
Polycom Touch Control Indicator Light .....	1-16
Polycom EagleEye Director Indicator Light .....	1-16
Configuring the Polycom HDX System .....	1-16
Setup Wizard .....	1-16
Admin Settings .....	1-17

## 2 Networks

Getting the Network Ready .....	2-1
Connecting to the LAN .....	2-1

LAN Status Lights .....	2-2
Configuring LAN Properties .....	2-2
Configuring Polycom HDX System LAN Properties .....	2-3
Configuring the Polycom Touch Control LAN Properties .....	2-7
Configuring IP Settings .....	2-8
Specifying H.323 Settings .....	2-8
Configuring the System to Use a Gatekeeper .....	2-9
IPv6 Gatekeeper Support .....	2-11
Configuring Integration with Avaya Networks .....	2-12
Configuring the System to Use a Gateway .....	2-14
Specifying SIP Settings .....	2-15
Configuring SIP Settings for Integration with Microsoft Office Communications Server 2007 R2 and Microsoft Lync Server 2010 .....	2-18
Configuring SIP Settings for Integration with the Telepresence Interoperability Protocol (TIP) .....	2-19
RTV and Lync-Hosted Conference Support .....	2-20
Specifying Quality of Service .....	2-20
Polycom Video Error Concealment and Dynamic Bandwidth .....	2-20
Quality of Service Settings .....	2-21
Configuring the System for Use with a Firewall or NAT .....	2-22
Firewall Settings .....	2-22
H.460 Firewall/NAT Traversal .....	2-24
Basic Firewall/NAT Traversal Connectivity .....	2-25
Connecting Polycom HDX Systems to ISDN or Other Networks .....	2-26
Quad BRI Network Interface Status Lights .....	2-28
PRI Network Interface Status Lights .....	2-28
Serial V.35/RS-449/RS-530 Network Interface Status Lights .....	2-29
Configuring ISDN and Other Network Interface Settings .....	2-29
Configuring the BRI Network Interface .....	2-29
Configuring the PRI Network Interface .....	2-31
Configuring the Serial V.35/RS-449/RS-530 Network Interface .....	2-33
Connecting to an Analog Phone Line .....	2-35
Configuring Telephony .....	2-36
Configuring Call Preferences .....	2-37
Configuring Dialing Order Settings .....	2-41

### 3 Monitors and Cameras

Connecting Monitors .....	3-1
Connecting Monitors to Polycom HDX 9000 Series Systems .....	3-1
Connecting Monitors to Polycom HDX 8000 Series or Polycom HDX 7000 Series Systems .....	3-2
Connecting a Monitor to Polycom HDX 6000 Series Systems .....	3-2
Connecting a Monitor to a Polycom HDX 4500 System .....	3-3
Using a Polycom HDX 4000 Series System Monitor with a Computer .....	3-3
Configuring Monitor Settings .....	3-3
Using Dual Monitor Emulation .....	3-9
Examples of Dual Monitor Emulation .....	3-10
Using Dual Monitor Emulation in a Call .....	3-10
Configuring Multipoint Viewing Modes .....	3-11

Adjusting the Monitor's Color Balance, Sharpness, and Brightness	3-12
Preventing Monitor Burn-In	3-13
Connecting Cameras	3-14
Polycom EagleEye HD	3-14
Polycom EagleEye 1080	3-15
Polycom EagleEye View	3-15
Polycom EagleEye II	3-15
Polycom EagleEye III	3-16
Polycom EagleEye Director	3-16
Connecting Cameras to Polycom HDX Systems	3-17
Polycom HDX 9000 Series Systems	3-17
Polycom HDX 8000 Series Systems	3-20
Polycom HDX 7000 Series Systems	3-21
Polycom HDX 6000 Series Systems	3-22
Polycom HDX 4000 Series Systems	3-23
Polycom HDX 4500 Systems	3-23
Configuring Camera Settings and Video Quality Options	3-24
Configuring the Polycom EagleEye Director	3-30
Getting Started	3-30
Calibrating the Cameras	3-31
Adjusting the Room View	3-31
Starting and Stopping Camera Tracking with EagleEye Director	3-32
Setting the Tracking Mode	3-33
Configuring Advanced Camera Settings	3-33
Configuring Camera Presets	3-35
Setting and Using Presets with the Remote Control or Keypad	3-35
Setting and Using Presets with the Polycom Touch Control	3-36
Experiencing High-Definition Video Conferencing	3-37
Sending Video in High Definition	3-37
Receiving and Displaying Video in High Definition	3-37
HD and SD Multipoint Calls	3-38

## 4 Microphones and Speakers

Connecting Audio Input	4-1
Connecting Audio Input to Polycom HDX 9000 Series Systems	4-1
Connecting Audio Input to Polycom HDX 8000 Series Systems	4-2
Connecting Audio Input to Polycom HDX 7000 Series Systems	4-2
Connecting Audio Input to Polycom HDX 6000 Series Systems	4-2
Connecting Audio Input to Polycom HDX 4000 Series Systems	4-3
Connecting Devices to the Polycom HDX Microphone Input	4-3
Connecting Polycom HDX Table or Ceiling Microphones	4-3
Using the Polycom EagleEye View Microphones	4-3
Connecting a Polycom SoundStation IP 7000 Phone	4-4
Connecting Devices to the Polycom HDX 9000 Series Microphone Input	4-4
Connecting Devices to the Polycom HDX 8000 Series Microphone Input	4-5
Connecting Devices to the Polycom HDX 7000 Series Microphone Input	4-6

Connecting Devices to the Polycom HDX 6000 Series Microphone Input .....	4-7
Connecting Devices to the Polycom HDX 4000 Series Microphone Input .....	4-7
Placing Polycom Microphones to Send Stereo from Your Site .....	4-8
Polycom Microphone Lights .....	4-9
Connecting Non-Polycom Microphones or a Mixer to a Polycom HDX System .....	4-9
Connecting Audio Output .....	4-10
Connecting Speakers to Polycom HDX 9000 Series Systems .....	4-11
Connecting Speakers to Polycom HDX 8000 Series or Polycom HDX 7000 Series Systems .....	4-11
Connecting Speakers to Polycom HDX 6000 Series Systems .....	4-12
Connecting Speakers to Polycom HDX 4500 Systems .....	4-12
Connecting Speakers or Headphones to Polycom HDX 4000 Series Systems .....	4-12
Placing Speakers to Play Stereo from Far Sites .....	4-12
Setting the Speaker Volume .....	4-13
Configuring Audio Settings .....	4-14
General Audio Settings .....	4-14
StereoSurround Settings .....	4-19
Audio Meters .....	4-20
Testing StereoSurround .....	4-20
Polycom HDX System Settings for a Polycom Vortex Mixer .....	4-21
Settings for Non-Polycom Microphones .....	4-22

## 5 Content and Closed Captions

Connecting VCR/DVDs .....	5-2
Configuring VCR/DVD Player Settings .....	5-2
Playing a Videotape or DVD .....	5-2
Recording a Call to Videotape or DVD .....	5-2
Connecting Computers to Polycom HDX Systems .....	5-3
Configuring Content Sharing .....	5-4
Sending Analog and Digital Content .....	5-5
Configuring Content Display with People+Content IP .....	5-5
Configuring People on Content™ .....	5-6
Setting Up the Room for People on Content .....	5-6
Enabling and Calibrating People on Content on the System .....	5-7
Manually Setting White Balance .....	5-8
Configuring UC Board™ .....	5-8
Configuring Closed Captioning .....	5-9
Via a Dial-Up Connection to the Systems' RS-232 Serial Port .....	5-10
Via the System's Serial RS-232 Port .....	5-11
Via the Polycom HDX Web Interface .....	5-12

## 6 Calling and Answering

Configuring Call Settings	6-1
Setting the Call Answering Mode	6-2
Configuring Multipoint Calling	6-3
Entering a Multipoint Option Key	6-3
Configuring the Conference on Demand Feature	6-4
Including Multiple Sites in a Cascaded Call	6-4
Configuring Directory Settings	6-6
Creating a Localized System Name with the Polycom HDX Web Interface	6-7
Managing Directories with the Polycom HDX Web Interface	6-8
Configuring the Global Directory	6-9
Directory Groups	6-13
Global Directory Groups	6-14
Favorites Group	6-14
Polycom Conferencing for Microsoft Outlook	6-15

## 7 System Location, Appearance, and Tones

Configuring Regional Settings	7-1
Configuring Polycom HDX Regional Settings	7-1
Configuring Polycom Touch Control Regional Settings	7-2
Customizing the Home Screen	7-3
Displaying Speed Dial Entries	7-6
Adding Marquee Text	7-6
Customizing Camera Names and Icons	7-7
Screen Savers	7-8
Adding Screen Saver Text	7-8
Adding a Screen Saver Logo	7-8

## 8 Security

Screens that Require a Password for Access	8-1
Configuring Security Options	8-2
Configuring Security Options for Polycom HDX Systems	8-2
Configuring Admin ID and Password for the Polycom Touch Control	8-6
Using the Sessions List	8-7
Enabling Secure Access	8-8
Using Security Profiles	8-8
Configuring Security Mode	8-9
Security Selections	8-10
Using the Maximum or High Security Profile	8-11
Using the Medium Security Profile	8-14
Using the Low Security Profile	8-17
Using the Minimum Security Profile	8-20
Enabling AES Encryption	8-23
Configuring Encryption Settings for Integration with Microsoft Office Communications Server 2007 R2 and Microsoft Lync Server 2010	8-24

Setting Password Policies .....	8-25
Setting the Room and Remote Access Passwords .....	8-26
Managing Certificates and Revocation .....	8-27
Working with Certificates .....	8-27
Using Certificate Signing Requests (CSRs) .....	8-29
Verifying Certificate Validity .....	8-30
Deleting Certificates and CRLs .....	8-32
Enabling a Whitelist .....	8-33
Managing Remote Access .....	8-34
Enabling External Authentication .....	8-34
Setting Account and Port Lockouts .....	8-36
Account Lockout .....	8-36
Port Lockout .....	8-38
Managing User Access to Settings and Features .....	8-40
Setting up Log Management .....	8-41
Setting up Polycom HDX Log Management .....	8-41
Managing Polycom Touch Control Logs .....	8-43

## 9 Managing the System Remotely

Using the Polycom HDX Web Interface .....	9-1
Accessing the Polycom HDX Web Interface .....	9-1
Monitoring a Room or Call with the Polycom HDX Web Interface .....	9-2
Managing System Profiles with the Polycom HDX Web Interface .....	9-3
Sending a Message .....	9-4
Configuring Global Services .....	9-4
Viewing the Management Servers List .....	9-4
Requiring an Account Number for Calls .....	9-5
Adding Information for the Global Management System Administrator .....	9-6
Requesting Technical Support from the Global Management System Administrator .....	9-6
Setting Up SNMP .....	9-6
Downloading MIBs .....	9-7
Configuring for SNMP Management .....	9-7
Using a Provisioning Service .....	9-8
Enabling or Disabling the Provisioning Service .....	9-9
Provisioning Service Settings .....	9-10
Keeping your Software Current .....	9-11

## 10 Control Devices

Configuring Remote Control Behavior .....	10-1
Configuring the Remote Control Channel ID .....	10-3
Configuring the Remote to Control a Recording Device .....	10-3
Connecting Control and Accessibility Equipment .....	10-4
Connecting Non-Polycom Touch-Panel Controls .....	10-4
Connecting IR Sensors to Polycom HDX Systems .....	10-4

Configuring RS-232 Serial Port Settings .....	10-5
Setting Up the Polycom Touch Control Device .....	10-6
Pairing and Unpairing a Polycom Touch Control Device and a Polycom HDX System .....	10-7
Pairing .....	10-8
Unpairing .....	10-9

## 11 Statistics and Diagnostics

Diagnostics Screens .....	11-1
System Status .....	11-2
Server Status .....	11-3
Call Summary .....	11-3
Call Statistics .....	11-3
Network .....	11-5
Video (Monitors) .....	11-6
Video Cameras .....	11-6
Audio .....	11-7
Reset or Restart System .....	11-8
Send a Message .....	11-8
System Log .....	11-8
Sessions .....	11-8
Recent Calls .....	11-9
Call Detail Report (CDR) .....	11-9
Information in the CDR .....	11-10
Call Detail Report Archives .....	11-13
System Logs .....	11-13
Downloading System Logs from the Polycom HDX Web Interface .....	11-13
System Log Settings in the Polycom HDX Web Interface .....	11-14
Downloading EagleEye Director Logs .....	11-14

## 12 Troubleshooting

Placing a Test Call .....	12-1
Enabling Diagnostic Mode .....	12-2
Using the Restore Button on the Polycom HDX System .....	12-2
Restoring Configuration .....	12-4
Performing a Factory Restore .....	12-4
Deleting Files .....	12-5
Performing a Factory Restore on the Polycom Touch Control .....	12-6
Performing a Factory Restore on the Polycom EagleEye Director .....	12-6
Changing the Video Format .....	12-7
How to Contact Technical Support .....	12-8
Polycom Solution Support .....	12-8

## A System Back Panel Views

Video Inputs and Outputs .....	A-1
--------------------------------	-----

Polycom HDX 9006 .....	A-1
Polycom HDX 9004 .....	A-2
Polycom HDX 9001 and Polycom HDX 9002 .....	A-2
Polycom HDX 8000 Series System .....	A-3
Polycom HDX 7000 Series System (Hardware Versions A, B, C) .....	A-3
Polycom HDX 7000 System with Hardware Version D .....	A-4
Polycom HDX 6000 Series System .....	A-4
Polycom HDX 4000 and Polycom HDX 4000 HD Systems .....	A-5
Polycom HDX 4500 System .....	A-5
Audio Inputs and Outputs .....	A-6
Polycom HDX 9006 .....	A-6
Polycom HDX 9004 .....	A-6
Polycom HDX 9001 and Polycom HDX 9002 .....	A-7
Polycom HDX 8000 Series System .....	A-7
Polycom HDX 7000 Series System (Hardware Versions A, B, C) .....	A-8
Polycom HDX 7000 System with Hardware Version D .....	A-8
Polycom HDX 6000 Series System .....	A-9
Polycom HDX 4000 and Polycom HDX 4000 HD Systems .....	A-9
Polycom HDX 4500 System .....	A-10
Network/Power/Control Inputs and Outputs .....	A-10
Polycom HDX 9006 .....	A-10
Polycom HDX 9004 .....	A-11
Polycom HDX 9001 and Polycom HDX 9002 .....	A-11
Polycom HDX 8000 Series System .....	A-12
Polycom HDX 7000 Series System (Hardware Versions A, B, C) .....	A-12
Polycom HDX 7000 System with Hardware Version D .....	A-13
Polycom HDX 6000 Series System .....	A-13
Polycom HDX 4000 and Polycom HDX 4000 HD Systems .....	A-14
Polycom HDX 4500 System .....	A-14

## **B Port Usage**

## **C Call Speeds and Resolutions**

Point-to-Point Dialing Speeds .....	C-1
Multipoint Dialing Speeds .....	C-1
Call Speeds and Resolutions .....	C-4
SD Systems (NTSC) .....	C-4
HD 720p Systems (NTSC) .....	C-5
HD 1080p Systems (NTSC) .....	C-6
H.264 High Profile .....	C-7
High Profile on Polycom HDX 6000 HD .....	C-7
High Profile on Polycom HDX 4000 HD, Polycom HDX 4500, Polycom HDX 7000 HD, Polycom HDX 8000 HD, and Polycom HDX 9006 .....	C-8
Maximum Resolution (720p) on Polycom HDX 7000 Systems .....	C-9
Maximum Resolution (1080p) on Polycom HDX 6000 Systems .....	C-10



Resolution and Frame Rates for Content Video .....	C-10
Polycom HDX 9006, Polycom HDX 8000 HD with Hardware Version B, Polycom HDX 7000 with Hardware Version C or D, Polycom HDX 4500, Polycom HDX 4000 with Hardware Version C Systems .....	C-11
Polycom HDX 9004, Polycom HDX 9002, and Polycom HDX 9001 Systems .....	C-11
Polycom HDX 6000 System .....	C-12

## **D Codes for Remote Control Recording Device Buttons**

DVD Player Codes .....	D-1
DVD Recorder Codes .....	D-2
VCR Device Codes .....	D-3
PVR Device Codes .....	D-5

## **Index ..... Index-1**



---

# Introducing the Polycom HDX Systems

Your Polycom HDX video conferencing system is a state-of-the-art visual collaboration tool. With crisp, clean video and crystal-clear sound, Polycom HDX systems provide natural video conferencing interaction through the most advanced video communications technology.

## Polycom HDX Systems

For technical specifications and detailed descriptions of features available for Polycom HDX models, please refer to the product literature available at [www.polycom.com](http://www.polycom.com).

### Polycom HDX 9000 Series Systems



The Polycom HDX 9000 series provides high-definition (HD) voice, video, and content for medium to large conference rooms. The Polycom HDX 9000 series provides integrator-class connectors and supports multiple video and audio sources. These solutions allow integrators to create specialized and unique, real-time video environments for their customers. The Polycom HDX 9000 series includes several models: Polycom HDX 9006, Polycom HDX 9004, Polycom HDX 9002, and Polycom HDX 9001.

The Polycom HDX 9006 systems can send and receive wide-screen, high-definition (HD) video in point-to-point and multipoint calls in 1080p video.

The Polycom HDX 9004 and Polycom HDX 9002 systems can send and receive wide-screen, high-definition (HD) video in point-to-point and multipoint calls. The Polycom HDX 9001 sends and receives up to standard-definition (SD) video.

## Polycom HDX 8000 Series Systems



The Polycom HDX 8000 series provides high-definition (HD) voice, video, and content for medium to large conference rooms. These systems incorporate leading-edge design with performance, flexibility, and capabilities, making them the optimal solution for meeting spaces in any organization. The Polycom HDX 8000 series systems can send and receive wide-screen, HD 720p video in point-to-point and multipoint calls. Polycom HDX 8000 series systems with the 1080p Resolution option installed can send and receive full HD (1080p) video.

The Polycom HDX 8000 series systems ship with a Polycom EagleEye camera, Polycom HDX microphones, and a Polycom HDX remote control. Bundles including displays and furniture are also available.

## Polycom HDX 7000 Series Systems



The Polycom HDX 7000 series provides voice, video, and content for small to medium conference rooms. These systems incorporate leading-edge design with performance, flexibility, and capabilities, making them the optimal solution for meeting spaces in any organization.

The Polycom HDX 7000 series has two models: the Polycom HDX 7000 system and the Polycom HDX 7000 HD system. The Polycom HDX 7000 system is an SD system that sends and receives video in SD resolutions. The Polycom HDX 7000 HD system is an HD system that sends and receives HD video. Both models include a Polycom EagleEye HD camera, Polycom HDX microphone, and a Polycom HDX remote control. Polycom HDX 7000 series systems with the 1080p Resolution option installed can send and receive full HD (1080p) video.

Bundles including displays and furniture are also available.

## Polycom HDX 6000 Series Systems



The Polycom HDX 6000 series provides voice, video, and content for small to medium conference rooms. These systems incorporate leading-edge design with performance, flexibility, and capabilities, making them the optimal solution for meeting spaces in any organization.

The Polycom HDX 6000 HD system is an HD system that sends and receives HD video. Polycom HDX 6000 series systems with the 1080p Resolution option installed can send and receive full HD (1080p) video.

The Polycom HDX 6000 series systems ship with a Polycom EagleEye camera, a Polycom HDX microphone, and a Polycom HDX remote control. Bundles including displays and furniture are also available.

## Polycom HDX 4000 Series Systems



The Polycom HDX 4000 series provides the ultimate in desktop video conferencing, designed to allow today's professionals to be more productive and effective right from their office. With LCD screens, powerful stereo speakers, and sleek design, these systems are much more than communications devices; they are also fully functional monitors for your PC or Macintosh. The Polycom HDX 4000 series has three models: the Polycom HDX 4000 system, the Polycom HDX 4000 HD system, and the Polycom HDX 4500 system.

The Polycom HDX 4000 system is an SD system that sends and receives video in 4CIF/4SIF resolutions. The Polycom HDX 4000 HD system with Hardware Version C is an HD system that sends and receives H.264 High Profile video. The system can receive 720p and 1080p people video.

Built into the Polycom HDX 4000 and Polycom HDX 4000 HD systems are a Pan Tilt Zoom (PTZ) camera, four speakers, and dual microphones.



The Polycom HDX 4500 system is the latest executive desktop video conferencing system in the Polycom HDX 4000 series. The system has a 24" screen, powerful stereo speakers, and sleek design and can send and receive up to 1080p, HD video. You can attach a second monitor to the Polycom HDX 4500 system.

Built into the Polycom HDX 4500 system are a Pan Tilt Zoom (PTZ) camera, two speakers, and dual microphones.

To find out which hardware version you have, go to **System > System Information**.



The Polycom HDX 4500 system is the only Polycom HDX 4000 series system that supports the Polycom Touch Control. When a Polycom Touch Control is paired with the Polycom HDX 4500 system, the keypad and remote control are disabled.

## Setting Up Your System Hardware

This manual provides information to supplement the setup sheets provided with your system and its optional components. A printed copy of the system setup sheet is provided with each Polycom HDX system. PDF versions of the system setup sheets are available at [www.polycom.com/videodocumentation](http://www.polycom.com/videodocumentation).

## Positioning the System

### Positioning the Polycom HDX 9000 Series Systems

Polycom HDX 9000 series systems are designed to be placed on a tabletop or in an equipment rack.

#### To position the system:

- 1 Install the mounting brackets on the system if you need to mount it in an equipment rack, or install the self-adhesive feet if you will place the system on a table or shelf.

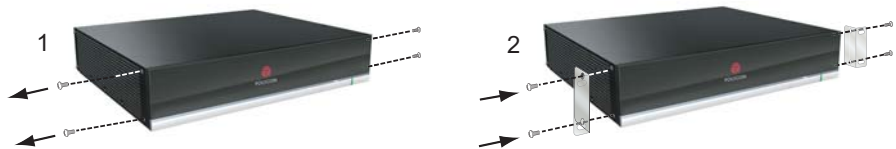

- 2 Place the system in the desired location. Position the system so that the camera does not face toward a window or other source of bright light. Leave enough space to connect the cables easily. Place the camera and display together so that people at your site face the camera when they are looking at the display.



### Positioning the Polycom HDX 8000 Series, Polycom HDX 7000 Series, or Polycom HDX 6000 Series Systems

Polycom HDX 8000 series, Polycom HDX 7000 series, and Polycom HDX 6000 series systems can be set up in multiple ways. When used with furniture such as a pedestal or wall mount, the system fits into a bracket on the back of the display. The system can also be placed in a cart or on a table.

**To position the system:**

- >> Position the system so that the camera does not face toward a window or other source of bright light. Leave enough space to connect the cables easily. Place the camera and display together so that people at your site face the camera when they are looking at the display.



If you need to position the system horizontally, remove the stand and install the self-adhesive feet.

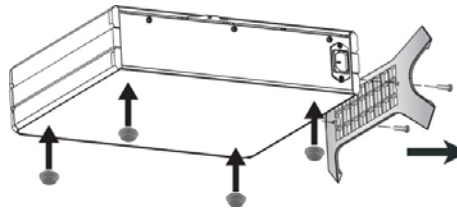

**Caution. Risk of Electric Shock.** To reduce the risk of personal injury or damage to the equipment, do not use screws longer than those supplied (M4x16, 8.00 mm maximum head diameter) to reconnect the stand to the system.

## Positioning the Polycom HDX 4000 Series Systems

The Polycom HDX 4000 series systems are personal video conferencing systems for the desktop.

The Polycom HDX 4500 system is an all-in-one device with the monitor and system combined. Position the system so that the camera does not face toward a window or other source of bright light.

**To position the Polycom HDX 4000 or HDX 4000 HD system:**

- 1 Place the monitor on the desktop, leaving enough space to connect the cables easily. Position the system so that the camera does not face toward a window or other source of bright light.



Caution. Risk of Electric Shock. To reduce the risk of personal injury or damage to the equipment, use the outlet on the back of the Polycom HDX 4500 only to plug the display into the system.

- 2 Place the Polycom HDX 4000 or Polycom HDX 4000 HD system either under the desk, or on the desk next to the display. The cables that connect the display to the system can be hidden in the monitor stand, providing clean cable management.

Polycom HDX 4500 system

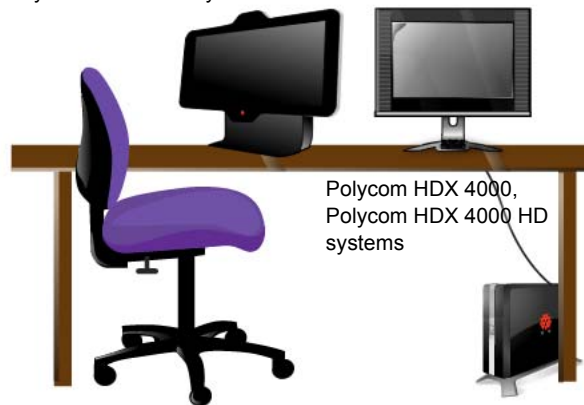

If you need to position one of the Polycom HDX 4000 systems horizontally, remove the stand and install the self-adhesive feet.

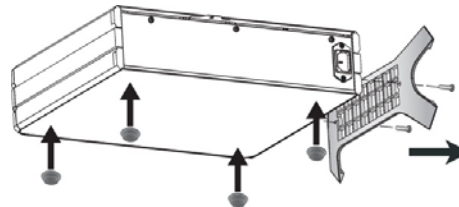

Caution. Risk of Electric Shock. To reduce the risk of personal injury or damage to the equipment, do not use screws longer than those supplied (M4x16, 8.00 mm maximum head diameter) to reconnect the stand to the system.

## Positioning the Polycom Touch Control Device

Polycom HDX 9000 series, Polycom HDX 8000 series, Polycom HDX 7000 series, Polycom HDX 6000 series, and the Polycom HDX 4500 systems can be controlled by the Polycom Touch Control.

Ensure that the Touch Control is conveniently located for use during a meeting.



When the Polycom Touch Control is not paired with a Polycom HDX system, the device can be used as a virtual remote control. To use the Polycom Touch Control as a virtual remote control, ensure that the infrared (IR) transmitter on the front of the device is facing the Polycom HDX system you want to control.

When the Polycom Touch Control is paired with a Polycom HDX system, the HDX system's IR remote control is inoperable.

## Positioning the Polycom EagleEye Director

The Polycom EagleEye Director is a new HD automatic camera positioning system that works with Polycom HDX 9000 series, Polycom HDX 8000 series, Polycom HDX 7000 series, and Polycom HDX 6000 series systems. Refer to [Polycom EagleEye Director](#) on page 3-16 for more information about the device.

Follow these guidelines when you use the Polycom EagleEye Director with your HDX system:

- Avoid setting the Polycom EagleEye Director in the corner of a room. The Polycom EagleEye Director should be at least 12 inches away from all of the walls.
- Make sure the Polycom EagleEye Director is on a level surface or mounting bracket.
- To ensure the best view from the Polycom EagleEye Director voice-tracking feature, follow these suggestions:

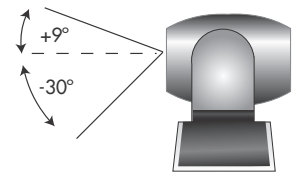

- Set the Polycom EagleEye Director on top of a monitor. Ideally, place the device between 5.5 and 7 feet from the ground.

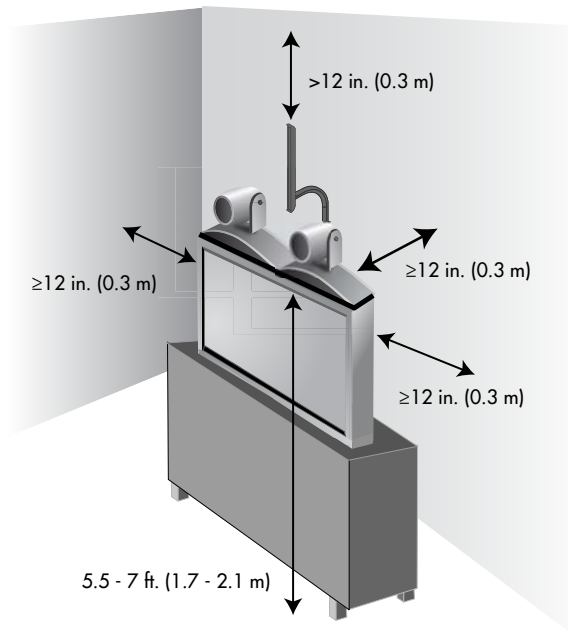

- Ensure that people are sitting within the viewing range of between 3 and 22 feet from the device.

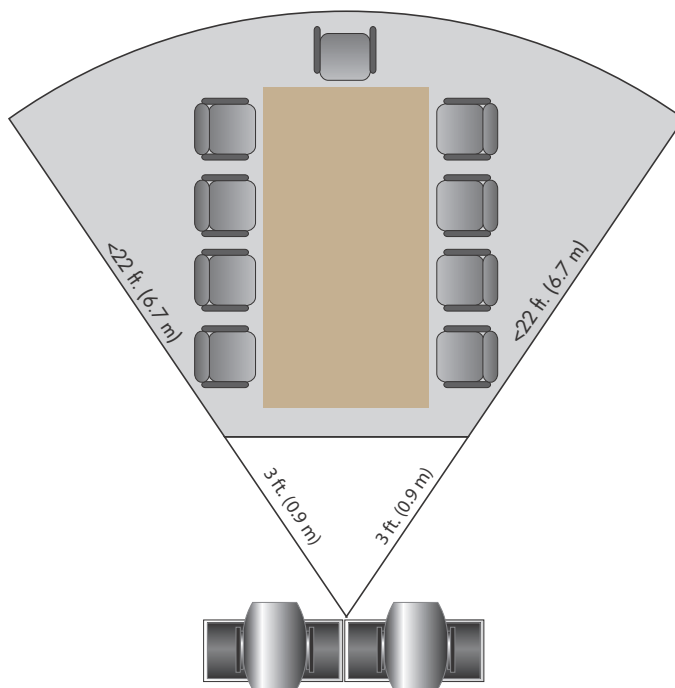

## Powering On and Off

Connect power and power on the HDX system after you have connected all of the equipment that you will use with it. Make sure that the system is powered off before you connect devices to it.



**Caution.** In order to avoid corrupting the file system, always power off a Polycom HDX system using the power button on the system or the remote control, if the remote control is configured to allow the system to be powered off. After turning the power off in this way, wait at least 15 seconds before you unplug the system from its power source. This helps ensure that the system powers off correctly.



The  **Power** button affects any HDX system within the range of the remote control, regardless of the Channel ID setting.

For instructions on how to power on and off the Polycom Touch Control, refer to [Powering On the Polycom Touch Control Device](#) on page 1-15.

### Power-On Self Test (POST)

After the splash screen is displayed, the HDX system automatically performs system health checks every time the system starts. As each check begins, a message appears on Monitor 1.

If a test fails, press **Hangup**  on the remote control to continue the startup process. However, even if the system appears to start up, Polycom recommends that you contact Technical Support before using your HDX system if any system tests fail.

### Powering On the Polycom HDX 9000 Series Systems

**To power on the Polycom HDX 9000 series, do one of the following:**

- Press the  power button on the remote control.
- Press the power switch on the front of the system.

The Polycom splash screen is displayed within about 10 seconds.

**To power off the Polycom HDX 9000 series, do one of the following:**

- Press and hold the  power button on the remote control for 2 seconds.
- Press and hold the power switch on the front of the system for 2 seconds.

After turning the power off in this way, wait at least 15 seconds before you unplug the system from its power source.

## Polycom HDX 9000 Series Indicator Light

The following figure shows the location of the power switch and indicator light.



The indicator light on the front of the Polycom HDX 9000 series system provides this information:

Indicator Light	System Status
Off	System is powered off.
Steady green light	System is initializing. System is awake.
Blinking green light	System received an IR (infrared) signal.
Steady amber light	System is asleep.
Alternating green and amber lights	System is in software update mode. System is in factory restore mode.

## Powering On the Polycom HDX 8000 Series, Polycom HDX 7000 Series, or Polycom HDX 6000 Series Systems

**To power on the Polycom HDX 8000 series, Polycom HDX 7000 series, or Polycom HDX 6000 series system, do one of the following:**

- Press the  power button on the remote control.
- Press the power switch on the front of the system.

The Polycom splash screen is displayed within about 10 seconds.

**To power off the Polycom HDX 8000 series, Polycom HDX 7000 series, or Polycom HDX 6000 series system, do one of the following:**

- Press and hold the  power button on the remote control for 2 seconds.
- Press and hold the power switch on the front of the system for 2 seconds.

After turning the power off in this way, wait until the power light stops flashing, which might take several seconds, before you unplug the system from its power source.

## Polycom HDX 8000 Series, Polycom HDX 7000 Series, and Polycom HDX 6000 Series Indicator Light

The indicator light on the front of the Polycom HDX 8000 series, Polycom HDX 7000 series, and Polycom HDX 6000 series systems provides this information:

Indicator Light	System Status
Off	System is without power.
Steady blue light	System is initializing. System is awake.
Blinking blue light	System received an IR (infrared) signal.
Steady amber light	System is asleep.
Alternating blue and amber lights	System is in software update mode. System is in factory restore mode.

## Powering On the Polycom HDX 4000 Systems

**To power on a Polycom HDX 4000 system, do one of the following:**

- Press the power button on the front of the system.
- Press the power button on the side of the monitor.

The Polycom splash screen is displayed within about 10 seconds.

**To power off a Polycom HDX 4000 system monitor:**

- >> Press the power button on the side of the monitor.

The monitor enters standby mode. The system stays powered on.

**To power off a Polycom HDX 4000 system, do one of the following:**

- Press and hold the power button on the side of the monitor.  
The monitor and the system power off.
- Press and hold the power button on the front of the system.  
The monitor and the system power off.

After turning the power off in this way, wait at least 15 seconds before you unplug the system from its power source.

## Polycom HDX 4000 Systems Indicator Lights

The following figure shows the location of the power switches and indicator lights.

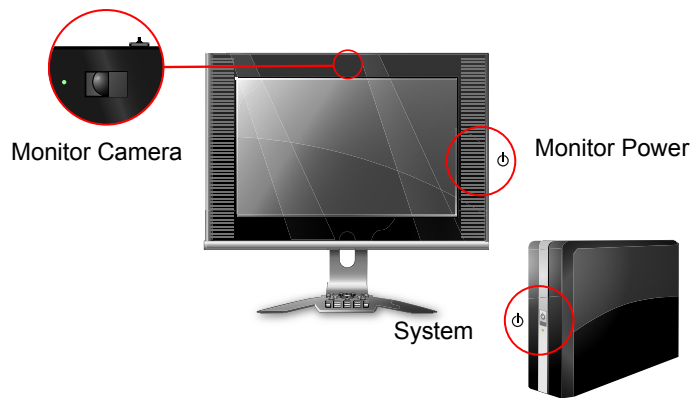

The indicator light on the front of the Polycom HDX 4000 systems provides this information:

Indicator Light (System)	Status
Off	System is without power.
Steady blue light	System is initializing. System is awake.
Blinking blue light	System received an IR (infrared) signal.
Steady amber light	System is asleep.
Alternating blue and amber lights	System is in software update mode. System is in factory restore mode.

The indicator light on the side of the Polycom HDX 4000 systems provides this information:

Indicator Light (Monitor Power)	Status
Off	Monitor is powered off.
Steady blue light	Monitor is powered on.
Steady amber light	Monitor is in standby mode.
Rapidly blinking light	Monitor is not connected correctly to the system. Verify that the monitor is connected correctly according to the setup sheet you received with the system.

The indicator light next to the built-in camera in the Polycom HDX 4000 systems provides this information:

Indicator Light (Monitor Camera)	Status
Off	System is not in a call.
Steady green light	System is in a call.
Blinking green light	System is in a call with the privacy shutter closed.

## Powering the Polycom HDX 4500 System On and Off

### To power on the Polycom HDX 4500 system:

>> Press the power button on the side of the monitor.

The Polycom splash screen is displayed within about 10 seconds.

### To power off the Polycom HDX 4500 system:

>> Press and hold the power button on the side of the monitor.

The monitor and the system power off.

### To power off the Polycom HDX 4500 system monitor:

>> Press the power button on the side of the monitor.

The monitor enters standby mode. The system stays powered on.

## Polycom HDX 4500 System Indicator Lights

The following figure shows the location of the power switch and indicator lights.

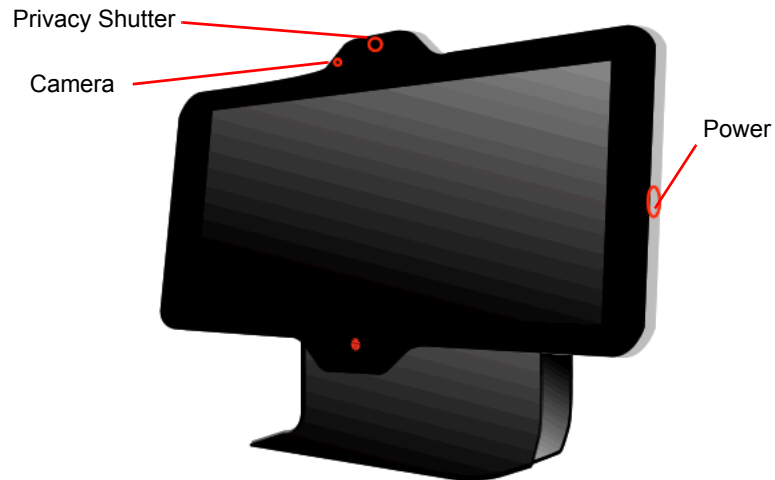

The Polycom HDX 4500 system does not have a separate light for the system. The light on the right side of the monitor indicates power for the monitor and the system.

This indicator light provides the following information:

Indicator Light (System)	Status
Off	System is without power.
Steady blue light	System is initializing. System is awake.
Blinking blue light	System is receiving an IR signal.
Steady amber light	System is asleep.
Alternating blue and amber lights	System is in software update mode. System is in factory restore mode.
Rapidly blinking amber light	System is shutting down.



The indicator light next to the built-in camera in the Polycom HDX 4500 system provides this information:

Indicator Light (Monitor Camera)	Status
Off	System is not in a call.
Steady green light	System is in a call.
Blinking green light	System is in a call with the privacy shutter closed.

## Powering On the Polycom Touch Control Device

### To power on the Polycom Touch Control:

- 1 Connect the Ethernet cable to the underside of the Polycom Touch Control.
- 2 Plug the Ethernet cable into the wall outlet.
  - If your room provides Power Over Ethernet, you can connect the Ethernet cable directly to a LAN outlet.
  - If your room does not provide Power Over Ethernet, you must connect the Ethernet cable to the optional power supply adapter. Then connect the power supply adapter to a LAN outlet and power outlet. The power supply adapter is sold separately.

The Polycom Touch Control powers on and displays the language selection screen.

### To power off the Polycom Touch Control:

- 1 From the Touch Control Home screen, touch  **User Settings**.
- 2 Scroll to the Power section.
- 3 Select **Touch Control Power**.
- 4 In the menu that appears, select **Power Off the Touch Control**. If you choose to power off the Polycom Touch Control, you must disconnect and reconnect the LAN cable to power it on again.

### To wake up the Polycom Touch Control:

The touch control goes to sleep after 2 minutes of inactivity. Touch the screen to wake it up.

## Polycom Touch Control Indicator Light

When the Polycom Touch Control is on, the  Home button is lit.

## Polycom EagleEye Director Indicator Light

The following figure shows the location of the power indicator light on the back of the Polycom EagleEye Director.

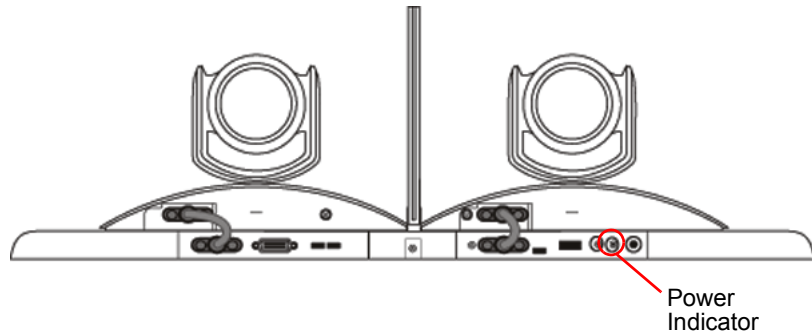

This indicator light provides the following information:

Indicator Light	Status
Steady blue light	Cameras are ready.
Steady red light	Cameras are powering on.
Blinking red light	Factory restore on the cameras is starting.

## Configuring the Polycom HDX System

### Setup Wizard

When you power on your system for the first time, the setup wizard detects the system's IP and ISDN connections and leads you through the minimum configuration steps required to place a call.



If you cannot see the user interface on the system's monitor, refer to [Changing the Video Format](#) on page 12-7.

The setup wizard allows you to set an Admin ID and password, which allows you to limit access to the Admin Settings. The default Admin ID is `admin` and the default admin room password is the 14-digit system serial number from the **System Information** screen or the back of the system. Admin and User IDs are not case sensitive.



Make sure you can recall the room password if you set one. If you forget the password, you must use the restore button to run the setup wizard again in order to access the Admin Settings and reset the password. For more information, refer to [Using the Restore Button on the Polycom HDX System](#) on page 12-2.

You can run the setup wizard or view the configuration screens in either of these two ways.

- **In the room with the system** – Use the remote control to navigate the screens and enter information. You can use the number pad on the remote control to enter text. Point the remote control at the camera to control Polycom HDX 8000 series, Polycom HDX 7000 series, and Polycom HDX 6000 series systems.
- **From a remote location** – If you know the IP address of the system, you can access and configure the HDX system by using the HDX web interface. For more information about using the web interface, refer to [Accessing the Polycom HDX Web Interface](#) on page 9-1.

The setup wizard is available during initial setup, after a software update or system reset with system settings deleted, or after using the restore button.

## Admin Settings

After you run the setup wizard, you can view or change the system's configuration by going to the Admin Settings in the system's local interface or web interface.



When a Polycom HDX system is paired with a Polycom Touch Control, the following statements are true:

- You can change the system's configuration using the web interface only.
- When prompted to enter the Admin Room ID and password and no Admin Room ID is configured, you can submit a blank password.

If you enable a security profile in the setup wizard, certain configuration settings are set and controlled automatically.

If you enable a provisioning service, any settings provisioned by the Polycom Converged Management Application® (CMA®) or Polycom RealPresence® Resource Manager system may be displayed as read-only settings in the Polycom HDX system interface. For more information about automatic provisioning, refer to the Polycom CMA or RealPresence Resource Manager system documentation on the Polycom web site.

The Polycom Touch Control has separate admin settings that allow you to update Touch Control software and configure LAN, regional, and security properties for the Touch Control. Refer to the following sections for more information:

- [Configuring the Polycom Touch Control LAN Properties](#) on page 2-7.
- [Configuring Polycom Touch Control Regional Settings](#) on page 7-2.
- [Configuring Admin ID and Password for the Polycom Touch Control](#) on page 8-6.
- [Managing Polycom Touch Control Logs](#) on page 8-43.

An admin ID and password might be configured for the Touch Control Administration settings. The default ID is `admin` and the default password is `456`.

---

# Networks

This guide covers network types used worldwide. Note that not all network types are available in all countries.

## Getting the Network Ready

Before you begin configuring the network options, you must make sure your network is ready for video conferencing.

To begin, refer to the *Network Planning Worksheets for Video Conferencing* document, available on the Polycom web site. This document contains information you need to prepare your network, such as worksheets that will help you order ISDN.

Polycom also offers contract high-definition readiness services. For more information, please contact your Polycom distributor.

## Connecting to the LAN

You must connect the system to a LAN to:

- Make H.323 or SIP calls
- Use a Global Directory Server
- Register with a management system
- Access the web interface
- Use People+Content™ IP
- Connect to the Polycom Touch Control

## LAN Status Lights

The LAN connector on the Polycom HDX 9000 series and Polycom HDX 6000 series has two lights to indicate connection status and traffic:

Indicator Light	Connection Status
Left light off	No 1000Base-T connection.
Left light green	1000Base-T connection. The light goes off each time a frame is transmitted or received.
Right light off	No 10/100Base-T connection.
Right light green	100Base-T connection. The light goes off each time a frame is transmitted or received.
Right light yellow	10Base-T connection. The light goes off each time a frame is transmitted or received.

The LAN connector on the Polycom HDX 8000 series, Polycom HDX 7000 series, and Polycom HDX 4000 series systems has two lights to indicate connection status and traffic:

Indicator Light	Connection Status
Left light off	No 100Base-T connection.
Left light green	100Base-T connection. The light goes off each time a frame is transmitted or received.
Right light off	No 10Base-T connection.
Right light green	10Base-T connection. The light goes off each time a frame is transmitted or received.

## Configuring LAN Properties

In IPv4/IPv6 hybrid networks, the system tries to place calls using the IPv6 address first. If that fails, the system tries to place the call using the IPv4 address.

You can configure LAN properties for the Polycom HDX Systems and for Polycom Touch Control Devices. Refer to [Configuring Polycom HDX System LAN Properties](#) on page 2-3 and [Configuring the Polycom Touch Control LAN Properties](#) on page 2-7.

## Configuring Polycom HDX System LAN Properties

### To configure Polycom HDX LAN properties:

- 1 Do one of the following:
  - In the local interface, go to **System > Admin Settings > LAN Properties** (select  if necessary).
  - In the web interface, go to **Admin Settings > LAN Properties**.
- 2 Configure these settings on the LAN Properties screen:

Setting	Description
<b>IP Address (IPv4)</b>	<p>Specifies how the system obtains an IP address.</p> <ul style="list-style-type: none"> <li>• <b>Obtain IP address automatically</b> — Select if the system gets an IP address from the DHCP server on the LAN.</li> <li>• <b>Enter IP address manually</b> — Select if the IP address will not be assigned automatically.</li> </ul> <p>Changing this setting causes the system to restart.</p>
<b>IP Address</b>	<p>If the system obtains its IP address automatically, this area displays the IP address currently assigned to the system.</p> <p>If you selected <b>Enter IP Address Manually</b>, enter the IP address here. Changing the IP address causes the system to restart.</p>
<b>Subnet Mask</b>	<p>Displays the subnet mask currently assigned to the system.</p> <p>If the system does not automatically obtain a subnet mask, enter one here.</p> <p>Changing this setting causes the system to restart.</p>
<b>Default Gateway (IPv4)</b>	<p>Displays the gateway currently assigned to the system.</p> <p>If the system does not automatically obtain a gateway IP address, enter one here.</p> <p>Changing this setting causes the system to restart.</p>

Setting	Description
<b>IP Address (IPv6)</b>	<p>Specifies how the system obtains an IP address.</p> <ul style="list-style-type: none"> <li>• <b>Obtain IP address automatically</b> — Select if the system gets an IP address automatically. DHCP is not currently supported for IPv6. When you choose this setting, the system uses Stateless Address Autoconfiguration (SLAAC) to obtain a global address, unique local address (ULA), or site-local address using router advertisements. The network routers also must be configured appropriately to provide the advertisement packets.</li> <li>• <b>Enter IP address manually</b> — Select if the IP address will not be assigned automatically.</li> <li>• <b>Off</b> — Select to disable IPv6.</li> </ul> <p>Changing this setting causes the system to restart.</p>
<b>Link-Local</b>	<p>Displays the IPv6 address used for local communication within a subnet.</p>
<b>Site-Local</b>	<p>Displays the IPv6 address used for communication within the site or organization.</p>
<b>Global Address</b>	<p>Displays the IPv6 internet address.</p>
<b>Default Gateway (IPv6)</b>	<p>Displays the gateway currently assigned to the system. If the system does not automatically obtain a gateway IP address, enter one here.</p> <p>Changing this setting causes the system to restart.</p>
<b>Host Name</b>	<p>Indicates the system's DNS name.</p> <p>Changing this setting causes the system to restart.</p>
<b>Domain Name</b>	<p>Displays the domain name currently assigned to the system. If the system does not automatically obtain a domain name, enter one here.</p>
<b>DNS Servers</b>	<p>Displays the DNS servers currently assigned to the system. If the system does not automatically obtain a DNS server address, enter up to four DNS servers here.</p> <ul style="list-style-type: none"> <li>• <b>IPv6:</b> You can specify IPv6 DNS server addresses for IP addresses entered manually or obtained automatically (in the case of a system on a hybrid network that obtains IPv4 DNS server addresses via DHCPv4).</li> <li>• <b>IPv4:</b> You can specify IPv4 DNS server addresses only when the IPv4 address is entered manually. When the IPv4 address is obtained automatically, the DNS Server addresses are also obtained automatically.</li> </ul> <p>Changing this setting causes the system to restart.</p>



Setting	Description
<b>LAN Speed</b>	<p>Specify the LAN speed to use. Note that the speed you choose must be supported by the switch.</p> <p>Choose <b>Auto</b> to have the network switch negotiate the speed automatically. Choosing <b>Auto</b> automatically sets <b>Duplex Mode</b> to <b>Auto</b>. If you choose <b>10 Mbps</b>, <b>100 Mbps</b>, or <b>1000 Mbps</b> you must set <b>Duplex Mode</b> to <b>Half</b> or <b>Full</b>.</p> <p><b>Note:</b> Polycom does not support <b>Auto</b> for the Polycom HDX system only or the switch only; the settings for both must be the same.</p> <p>Changing this setting causes the system to restart.</p>
<b>Duplex Mode</b>	<p>Specify the duplex mode to use. Note that the Duplex mode you choose must be supported by the switch.</p> <p>Choose <b>Auto</b> to have the network switch negotiate the Duplex mode automatically. Choosing <b>Auto</b> automatically sets <b>LAN Speed</b> to <b>Auto</b>.</p> <p>The duplex settings for both the Polycom HDX system and the switch must be the same. Polycom recommends that you set both to Auto. IEEE802.3 also recommends that you use Autonegotiation to avoid network issues.</p> <p>Changing this setting causes the system to restart.</p>
<b>Enable EAP/802.1X</b>	<p>Specifies whether EAP/802.1X network access is enabled. Polycom HDX systems support the following authentication protocols:</p> <ul style="list-style-type: none"> <li>• EAP-MD5</li> <li>• EAP-PEAPv0 (MSCHAPv2)</li> <li>• EAP-TTLS</li> <li>• EAP-TLS</li> </ul>
<b>Identity</b>	<p>Specifies the system's identity used for 802.1X authentication. This setting is available only when EAP/802.1X is enabled.</p>
<b>Password</b>	<p>Specifies the system's password used for 802.1X authentication. This setting is required when EAP/802.1X is enabled. The field cannot be blank.</p>
<b>Enable 802.1p/Q</b>	<p>Specifies whether VLAN and link layer priorities are enabled.</p>
<b>VLAN ID</b>	<p>Specifies the identification of the Virtual LAN. This setting is available only when 802.1p/Q is enabled. The value can be any number from 1 to 4094.</p>
<b>Video Priority</b>	<p>Sets the link layer priority of video traffic on the LAN. Video traffic is any RTP traffic consisting of video data and any associated RTCP traffic. This setting is available only when 802.1p/Q is enabled. The value can be any number from 0 to 7, although 6 and 7 are not recommended.</p>

Setting	Description
<b>Audio Priority</b>	Sets the priority of audio traffic on the LAN. Audio traffic is any RTP traffic consisting of audio data and any associated RTCP traffic. This setting is available only when 802.1p/Q is enabled. The value can be any number from 0 to 7, although 6 and 7 are not recommended.
<b>Control Priority</b>	<p>Sets the priority of control traffic on the LAN. Control traffic is any traffic consisting of control information associated with a call:</p> <ul style="list-style-type: none"> <li>• H.323—H.225.0 Call Signaling, H.225.0 RAS, H.245, Far End Camera Control</li> <li>• SIP—SIP Signaling, Far End Camera Control, Binary Floor Control Protocol (BFCP)</li> </ul> <p>This setting is available only when 802.1p/Q is enabled. The value can be any number from 0 to 7, although 6 and 7 are not recommended.</p>
<b>Enable PC LAN Port</b>	Specifies whether the PC LAN port is enabled on the back of a Polycom HDX 4000 series, Polycom HDX 7000, Polycom HDX 8000 series, or Polycom HDX 9006 system. Disable this setting for increased security.

The following IPv4 and IPv6 settings are available only on the web interface. Changing any of these settings causes the system to restart.

Setting	Description
<b>Ignore Redirect Messages</b>	Enables the HDX system to ignore redirect messages from network routers. A redirect message tells the endpoint to use a different router than the one it is using.
<b>ICMP Transmission Rate Limit (millisec)</b>	<p>Specifies the minimum number of milliseconds between transmitted packets. Enter a number between 0 and 60000. The default value of 1000 signifies that the system sends 1 packet per second. If you enter 0, the transmission rate limit is disabled.</p> <p>This setting applies only to “error” ICMP packets. This setting has no effect on “informational” ICMP packets, such as echo requests and replies.</p>
<b>Generate Destination Unreachable Messages</b>	Generates a Destination Unreachable message if a packet cannot be delivered to its destination for reasons other than network congestion.

Setting	Description
<b>Respond to Broadcast and Multicast Echo Requests</b>	Sends an Echo Reply message in response to a broadcast or multicast Echo Request, which is not specifically addressed to the HDX system.
<b>IPv6 DAD Transmit Count</b>	Specifies the number of Duplicate Address Detection (DAD) messages to transmit before acquiring an IPv6 address. The HDX system sends DAD messages to determine whether the address it is requesting is already in use.  Select whether to transmit 0, 1, 2, or 3 DAD requests for an IPv6 address.

## Configuring the Polycom Touch Control LAN Properties

To configure Polycom Touch Control LAN settings:

- 1 From the Home screen, touch  **Administration**.
- 2 Touch the **LAN Properties** tab.
- 3 Configure the following **IP Address (IPv4)** settings:

Setting	Description
<b>Set IP Address</b>	Specifies how the Touch Control obtains an IP address. <ul style="list-style-type: none"> <li>• <b>Obtain IP address automatically</b> — Select if the Touch Control gets an IP address from the DHCP server on the LAN.</li> <li>• <b>Enter IP address manually</b> — Select if the IP address is not automatically assigned.</li> </ul>
<b>IP Address</b>	Displays the IP address currently assigned to the Touch Control, if the Touch Control obtains its IP address automatically.  If you selected <b>Enter IP address manually</b> , enter the IP address here.
<b>Subnet Mask</b>	Displays the subnet mask currently assigned to the Touch Control.  If you selected <b>Enter IP address manually</b> , enter the subnet mask here.
<b>Default Gateway</b>	Displays the gateway currently assigned to the Touch Control.  If you selected <b>Enter IP address manually</b> , enter the gateway IP address here.

**4** Configure the following DNS settings:

Setting	Description
<b>Domain Name</b>	Displays the domain name currently assigned to the Touch Control. If the Touch Control does not automatically obtain a domain name, enter one here.
<b>DNS Servers</b>	Displays the DNS servers currently assigned to the Touch Control. If the Touch Control does not automatically obtain a DNS server address, enter up to two DNS servers here. You can specify IPv4 DNS server addresses only when the IPv4 address is entered manually. When the IPv4 address is obtained automatically, the DNS Server addresses are also obtained automatically.

**5** Optionally, view the general settings:

Setting	Description
<b>Duplex Mode</b>	Displays the duplex mode.
<b>LAN Speed</b>	Displays the LAN speed.

## Configuring IP Settings

### Specifying H.323 Settings

If your network uses a gatekeeper, the system can automatically register its H.323 name and extension. This allows others to call the system by entering the H.323 name or extension instead of the IP address.

**To specify H.323 settings:**

- 1** Do one of the following
  - In the local interface, go to **System > Admin Settings > Network > IP > H.323 Settings**.
  - In the web interface, go to **Admin Settings > Network > IP Network > H.323 Settings**.

## 2 Configure these settings on the H.323 Settings screen:

Setting	Description
<b>Display H.323 Extension</b>	Allows users to enter H.323 extensions separately from the gateway ID on the Place a Call screen. If your system is registered with a gatekeeper, this setting also displays your H.323 extension on the home screen.  If you do not select this setting, users make gateway calls by entering the call information in this format: gateway ID + ## + extension
<b>H.323 Name</b>	Specifies the name that gatekeepers and gateways use to identify this system. You can make point-to-point calls using H.323 names if both systems are registered to a gatekeeper. The H.323 Name is the same as the System Name, unless you change it. Your organization's dial plan may define the names you can use.
<b>H.323 Extension (E.164)</b>	Lets users place point-to-point calls using the extension if both systems are registered with a gatekeeper, and specifies the extension that gatekeepers and gateways use to identify this system.  Your organization's dial plan may define the extensions you can use.

## Configuring the System to Use a Gatekeeper

A gatekeeper manages functions such as bandwidth control and admission control. The gatekeeper also handles address translation, which allows users to make calls using static aliases instead of IP addresses that may change each day.

### To configure the system to use a gatekeeper:

- Do one of the following:
  - In the local interface, go to **System > Admin Settings > Network > IP > H.323 Settings** (select  if necessary).
  - In the web interface, go to **Admin Settings > Network > IP Network > H.323 Settings**.

2 Configure these settings:

Setting	Description
<b>Use Gatekeeper</b>	<p>Select this setting to use a gatekeeper. Gateways and gatekeepers are required for calls between IP and ISDN.</p> <ul style="list-style-type: none"> <li>• <b>Off</b> — Calls do not use a gatekeeper.</li> <li>• <b>Auto</b> — System attempts to automatically find an available gatekeeper.</li> <li>• <b>Specify</b> — Calls use the specified gatekeeper. This option must be selected to enable H.235 Annex D Authentication.</li> <li>• <b>Specify with PIN</b> — Calls use the specified E.164 address and require an <b>Authentication PIN</b>. This setting is available only when the Avaya® option key is installed.</li> </ul>
<b>H.323 Name</b>	<p>Specifies the name that gatekeepers use to identify this system. You can make point-to-point calls using H.323 names if both systems are registered to a gatekeeper. The H.323 Name is the same as the System Name, unless you change it. Your organization's dial plan may define the names you can use.</p>
<b>H.323 Extension (E.164)</b>	<p>Specifies the extension that gatekeepers and gateways use to identify this system. Your organization's dial plan may define the extensions you can use.</p>
<b>Primary Gatekeeper IP Address</b>	<ul style="list-style-type: none"> <li>• If you chose <b>No</b> for the <b>Use Gatekeeper</b> field, the <b>Primary Gatekeeper IP Address</b> field is not displayed.</li> <li>• If you chose to use an automatically selected gatekeeper, this area displays the gatekeeper's IP address.</li> <li>• If you chose to specify a gatekeeper, enter the gatekeeper's IP address or name (for example, gatekeeper.companyname.usa.com, or 10.11.12.13).</li> </ul> <p>The primary gatekeeper IP address contains the IPv4 or IPv6 address with which the system registers. As part of the gatekeeper registration process, the gatekeeper might return alternate gatekeepers. If communication with the primary gatekeeper is lost, the HDX system registers with the alternate gatekeeper but continues to poll the primary gatekeeper. If the system reestablishes communications with the primary gatekeeper, the HDX system unregisters from the alternate gatekeeper and reregisters with the primary gatekeeper.</p>
<b>Authentication</b>	<p>Enables support for H.235 Annex D Authentication. When H.235 Annex D Authentication is enabled, the H.323 gatekeeper ensures that only trusted H.323 endpoints are allowed to access the gatekeeper.</p>

Setting	Description
<b>User Name</b>	Specifies the user name for authentication with H.235 Annex D.
<b>Password</b>	Specifies the password for authentication with H.235 Annex D.
<b>Authentication PIN</b>	Specifies the password PIN to use for authentication with the Avaya Communication Manager®. This setting is available when <b>Use Gatekeeper</b> is set to <b>Specify with PIN</b> .
<b>Use PathNavigator for Multipoint Calls</b>	Lets you specify whether multipoint calls use the system's internal multipoint capability or the Conference on Demand feature available with Polycom PathNavigator™, ReadiManager SE200, or Polycom CMA systems. This feature is available only if the system is registered with one of these gatekeepers.

## IPv6 Gatekeeper Support

Support for HDX systems to register and use H.323 gatekeepers is now available on IPv6 networks. Polycom supports IPv6 registration and calling scenarios when registered to the DMA IPv6 gatekeeper. Most gatekeeper services currently available for IPv4 networks are also available on IPv6 networks, including the following:

- Direct and routed call methods
- Gatekeeper authentication
- H.323 Annex O dialing



### Points to Note about IPv6-only Network Limitations:

- A Polycom Global Directory Server address cannot be configured.
- Polycom Global Management System™, Polycom ReadiManager® SE200, Polycom CMA, and RealPresence Resource Manager systems cannot connect to the Polycom HDX system.
- Firewall traversal is not supported in environments that use a gatekeeper.
- Conference on Demand is not available.
- Registering with an alternate gatekeeper is not supported.
- When the H.323 setting for **Use Gatekeeper** is Auto, IPv6 functionality is disabled.
- Avaya gatekeepers are not supported.

Some gatekeeper settings are read only. In the local interface go to **System > Admin Settings > Network > IP > H.323 Settings** (select  if necessary) or **Admin Settings > Network > IP Network > H.323 Settings** in the web interface to view the following settings:

- **Current Gatekeeper IP Address**
- **Primary Gatekeeper IP Address**
- **Alternate Gatekeepers**  
These are gatekeepers that the system can use if the primary gatekeeper is not available. Supported gatekeepers include the Polycom PathNavigator™, RADVISION®, and Cisco gatekeepers.



**Points to note about Polycom's Conference on Demand feature:**

In order to place calls using Conference on Demand, you need to:

- Register your Polycom HDX system with a Polycom gatekeeper. A Polycom MGC™ or Polycom RMX® system must be configured with the gatekeeper to provide the Conference on Demand feature.
- Enable Use PathNavigator for Multipoint Calls.
- Create a group in the directory (recommended).

When using Conference on Demand:

- Once the call begins, you cannot add another site to the call — even if the site was in the call originally.
- The Polycom MGC or RMX system must have enough ports available to complete the call.

## Configuring Integration with Avaya Networks

Polycom HDX systems with an Avaya option key can use the following features on an Avaya telephony network:

- Call forwarding (all, busy, no answer)—Configured by the Avaya Communication Manager administrator and implemented by the user
- Call coverage—Configured by the Avaya Communication Manager administrator
- Transfer—Implemented via flash hook and dialing digits
- Audio conference—Implemented via flash hook and dialing digits
- Call park
- Answer back
- DTMF tones for Avaya functions

Refer to the Avaya documentation and *User's Guide for Polycom HDX Systems* for information about these features.







AES Encryption is not supported for systems registered to an Avaya H.323 gatekeeper.

#### To install the Avaya option key:

- 1 Obtain a license number from Avaya, then enter that number online on the Polycom web site at [www.polycom.com/support/video](http://www.polycom.com/support/video), along with your Polycom HDX system serial number. This returns a key code for the Avaya option.
- 2 On the Polycom HDX system go to **System > Admin Settings > General Settings > Options** and enter the key code for the Avaya option.

#### To configure the Polycom HDX system to use Avaya network features:

- 1 Do one of the following:
  - In the local interface, go to **System > Admin Settings > Network > IP > H.323 Settings** (select  if necessary).
  - In the web interface, go to **Admin Settings > Network > IP Network**.
- 2 Set **Use Gatekeeper to Specify with PIN**.
  - a Enter the **H.323 Extension (E.164)** provided by the Avaya Communication Manager administrator.
  - b Enter the Avaya Communication Manager IP address for **Gatekeeper IP Address**.
  - c Enter the **Authentication PIN** provided by the Avaya Communication Manager administrator.
- 3 Do one of the following:
  - In the local interface, go to **System > Admin Settings > Network > IP > Call Preference** (select  if necessary).
  - In the web interface, go to **Admin Settings > Network > IP Network > Call Preference**.
- 4 Set **Enable H.239**.
- 5 Do one of the following:
  - In the local interface, go to **System > Admin Settings > General Settings > System Settings > Call Settings** (select  if necessary).
  - In the web interface, go to **Admin Settings > General Settings > System Settings**.
- 6 Set **Auto Answer Point-to-Point Video** and **Auto Answer Multipoint Video** to No.

## Configuring the System to Use a Gateway

A gateway performs code and protocol conversion between H.323 (IP), SIP, and H.320 (ISDN), so that users on different networks can call one another. If the system is configured to use a gateway, you must also configure it to use a gatekeeper. For more information, refer to [Configuring the System to Use a Gatekeeper](#) on page 2-9.

### To configure the system to use a gateway:

- 1 Do one of the following:
  - In the local interface, go to **System > Admin Settings > Network > IP > H.323 Settings** (select  if necessary).
  - In the web interface, go to **Admin Settings > Network > IP Network > H.323 Settings**.
- 2 Configure these settings:

Setting	Description
<b>Country Code</b>	Specifies the country code for the system's location.
<b>Area Code</b>	Specifies the area or city code for the system's location.
<b>Number</b>	Specifies the gateway's number.
<b>H.323 Extension (E.164)</b>	Specifies the extension that identifies this system for incoming gateway calls. The default H.323 Extension can be changed.
<b>Gateway Number Type</b>	Specifies the number type users enter to call this system: <ul style="list-style-type: none"> <li>• <b>Direct Inward Dial</b> — Users enter an internal extension to call this system directly. <b>Note:</b> If you choose this setting, you must also register the number with the gatekeeper as an E.164 alias.</li> <li>• <b>Number + Extension</b> — Users enter the gateway number and the system's extension to call this system.</li> </ul>
<b>Number of Digits in DID Number</b>	Specifies the number of digits in the DID number. The national or regional dialing plan for your location determines the standard number of digits. For instance, the US standard is 7 digits.
<b>Number of Digits in Extension</b>	Specifies the number of digits in the extension used when <b>Direct Inward Dial</b> is selected. Your organization's dial plan determines this number.

- 3 Enter a prefix or suffix for each bandwidth you want to allow for gateway calls.

The use of suffixes and prefixes is dependent on the gatekeeper, gateway capability, and gateway configuration. Associating prefixes and suffixes with particular bandwidths on your gateway can optimize the use of bandwidth by your organization. Be sure the gateway is configured to use the same prefixes and suffixes you define for the system.

## Specifying SIP Settings

If your network supports the Session Initiation Protocol (SIP), you can use SIP to connect IP calls.

### To specify SIP Settings:

- 1 Do one of the following:
  - In the local interface, go to **System > Admin Settings > Network > IP > SIP Settings** (select  if necessary).
  - In the web interface, go to **Admin Settings > Network > IP Network > SIP Settings**.
- 2 Configure these settings:



If you installed the Microsoft real-time video (RTV) software option key, several of the SIP configuration fields described in the following table are named differently to align with Microsoft terminology.

Setting	Description
<p><b>SIP Server Configuration</b></p>	<p>Specifies whether to automatically or manually set the SIP server's IP address.</p> <p>If you select <b>Auto</b>, the two server address fields that follow cannot be edited. If you select <b>Specify</b>, those fields are editable.</p>
<p><b>Registrar Server</b></p>	<p>Specifies the IP address or DNS name of the SIP Registrar Server.</p> <ul style="list-style-type: none"> <li>• In a Microsoft Office Communications Server 2007 R2 or Microsoft Lync Server 2010 environment, specify the IP address or DNS name of the Office Communications Server or Lync Server.</li> <li>• If registering a remote HDX system with an Office Communications Server Edge Server or Lync Server Edge Server, use the fully qualified domain name of the access edge server role.</li> </ul> <p>By default for TCP, the SIP signaling is sent to port 5060 on the registrar server. By default for TLS, the SIP signaling is sent to port 5061 on the registrar server.</p> <p>Enter the IP address and port using the following format:            &lt;IP_Address&gt;:&lt;Port&gt;</p> <p>&lt;IP_Address&gt; can be an IPv4 address or a DNS hostname such as servername.company.com:6050. Hostnames can resolve to IPv4 or IPv6 addresses.</p> <p><b>Note:</b> If you have installed the RTV option key, this setting is named <b>Server name or IP address</b>.</p> <p>Syntax Examples:</p> <ul style="list-style-type: none"> <li>• To use the default port for the protocol you have selected: 10.11.12.13</li> <li>• To specify a different TCP or UDP port: 10.11.12.13:5071</li> </ul> <p>Enter an IPv6 address using the following format:            [&lt;IPv6_Address&gt;]:&lt;Port&gt;</p> <p>An example of an IPv6 address is:            [2001:db8:85a3::8a2e:370:7334]:8032</p>

Setting	Description
<b>Transport Protocol</b>	<p>Indicates the protocol the system uses for SIP signaling. The SIP network infrastructure in which your Polycom HDX system is operating determines which protocol is required.</p> <p><b>Auto</b> enables an automatic negotiation of protocols in the following order: TLS, TCP, UDP. This is the recommended setting for most environments.</p> <p><b>TCP</b> provides reliable transport via TCP for SIP signaling.</p> <p><b>UDP</b> provides best-effort transport via UDP for SIP signaling.</p> <p><b>TLS</b> provides secure communication of the SIP signaling. TLS is available only when the system is registered with a SIP server that supports TLS. When you choose this setting, the system ignores TCP/UDP port 5060.</p>
<b>Proxy Server</b>	<p>Specifies the DNS name or IP address of the SIP Proxy Server. If you leave this field blank, the Registrar Server is used. If you leave both the SIP Registrar Server and Proxy Server fields blank, no Proxy Server is used.</p> <p>By default for TCP, the SIP signaling is sent to port 5060 on the proxy server. By default for TLS, the SIP signaling is sent to port 5061 on the proxy server.</p> <p>The syntax used for this field is the same as for the Registrar Server field.</p> <p><b>Note:</b> If you have installed the RTV option key, this setting is hidden. In Microsoft networks, the Proxy server and the Registrar server are always the same server, so only one server address field is required.</p>
<b>User Name</b>	<p>Specifies the SIP address or SIP name of the system, for example, mary.smith@department.company.com. If you leave this field blank, the system's IP address is used for authentication.</p> <p><b>Notes:</b></p> <ul style="list-style-type: none"> <li>• If you have installed the RTV option key, this setting is named <b>Sign-in Address</b>.</li> <li>• This setting is required for registration with Microsoft Office Communications Server 2007 R2 or Microsoft Lync Server 2010.</li> </ul>
<b>Domain User Name</b>	<p>Specifies the name to use for authentication when registering with a SIP Registrar Server, for example, msmith@company.com. If the SIP proxy requires authentication, this field and the password cannot be blank.</p> <p><b>Notes:</b></p> <ul style="list-style-type: none"> <li>• If you have installed the RTV option key, this setting is named <b>User Name</b>.</li> <li>• This setting is required for registration with Microsoft Office Communications Server 2007 R2 or Microsoft Lync Server 2010.</li> </ul>

Setting	Description
<b>Password</b>	Specifies the password that authenticates the system to the Registrar Server.
<b>Microsoft Lync Server 2010</b>	Activates integration features such as the Microsoft global directory and Office Communicator contact sharing with presence.
<b>Domain Name</b>	Specifies the domain name used for authentication with the Microsoft Lync Server 2010 for directory access.  <b>Notes:</b> <ul style="list-style-type: none"> <li>This is a web-only setting.</li> <li>This setting appears only if <b>Microsoft Lync Server 2010</b> is checked.</li> </ul>
<b>Enable Network Intrusion Detection System (NIDS)</b>	Activates the ability to log entries to the security log when the system detects a possible network intrusion. This setting is automatically enabled when Security Mode is enabled and it cannot be changed. For more information about the types of packets that are detected, refer to the <i>Deployment Guide for Maximum Security Environments</i> .

For more information about this and other Microsoft/Polycom interoperability considerations, refer to the *Polycom Unified Communications Deployment Guide for Microsoft Environments*.



**Points to note about SIP:**

The SIP protocol has been widely adapted for voice over IP communications and basic video conferencing; however, many of the advanced video conferencing capabilities are not yet standardized. Many capabilities also depend on the SIP server.

The following are examples of features that are not supported using SIP:

- Cascaded multipoint in SIP calls.
- Meeting passwords. If you set a meeting password, SIP endpoints will be unable to dial in to a multipoint call.

For more information about SIP compatibility issues, refer to the *Release Notes for Polycom HDX Systems*.

## Configuring SIP Settings for Integration with Microsoft Office Communications Server 2007 R2 and Microsoft Lync Server 2010

Polycom HDX software versions 3.0.3 and later have been qualified with Microsoft Office Communications Server 2007 R2, while HDX software versions 3.0.5 and later have been certified with Microsoft Lync Server 2010. Integration with Office Communications Server and Lync Server allows Office Communicator and Polycom HDX system users to place audio and video calls to each other.



If a Polycom HDX system is running in dynamic management mode, it cannot be simultaneously registered with Office Communications Server or Lync Server and the presence service provided by a CMA or RealPresence Resource Manager system. Polycom HDX systems can obtain presence services from only one source: Office Communications Server and Lync Server, or the presence service provided by the CMA or RealPresence Resource Manager system.

Polycom supports the following features in Microsoft Office Communications Server 2007 R2 and Microsoft Lync Server 2010:

- Interactive Connectivity Establishment (ICE)
- Federated presence
- Real-time video
- Call hold and resume for Lync-hosted SIP calls

In addition, Polycom supports the Centralized Conferencing Control Protocol (CCCP) feature in Microsoft Lync Server 2010.

For more information about this and other Microsoft/Polycom interoperability considerations, refer to the *Polycom Unified Communications Deployment Guide for Microsoft Environments*.

If your organization deploys multiple Office Communications Server and Lync Server pools, a Polycom HDX system must be registered to the same pool to which the system's user account is assigned.

## Configuring SIP Settings for Integration with the Telepresence Interoperability Protocol (TIP)

When SIP is enabled on an HDX system that has the TIP option key, the HDX system can interoperate with TIP endpoints.



### Points to note about TIP:

- TIP is supported only on the following HDX systems:
  - Polycom HDX 9006
  - Polycom HDX 8000 HD with Hardware Version B
  - Polycom HDX 7000 HD with Hardware Version C or D
- HDX systems cannot host multipoint calls while in a SIP (TIP) call.
- SIP (TIP) calls must connect at a call speed of 1 Mbps or higher.
- Only TIP version 7 is supported.
- In a TIP call, only XGA content at 5 fps is supported. The following content sources are not supported in TIP calls:
  - USB content from the Polycom Touch Control
  - People+Content IP®

For more information about Polycom support for the TII protocol, refer to the *Polycom Unified Communications Deployment Guide for Cisco Environments*.

## RTV and Lync-Hosted Conference Support

To use RTV in a Lync-hosted conference, you must have the RTV option key enabled on one of the following HDX systems:

- Polycom HDX 9006
- Polycom HDX 8000 with Hardware Version B
- Polycom HDX 7000 with Hardware Version C or D
- Polycom HDX 6000
- Polycom HDX 4500
- Polycom HDX 4000 with Hardware Version C

For more information about configuring your Lync Server video settings for RTV, refer to the *Polycom Unified Communications Deployment Guide for Microsoft Environments*.

## Specifying Quality of Service

Set the Quality of Service options for the way your network handles IP packets during video calls.

### Polycom Video Error Concealment and Dynamic Bandwidth

You can handle video quality issues by enabling the PVEC (Polycom Video Error Concealment) setting, the Dynamic Bandwidth setting, or both settings.

If both settings are enabled, Dynamic Bandwidth adjusts the Video Rate in order to reduce packet loss to 3% or less. When the Packet Loss drops to 3% or less, PVEC cleans up the video image on your monitor. The additional processing power required might cause the Video Rate to drop while the system is using PVEC. If this happens, the Call Statistics screen shows the Video Rate Used as lower than the Video Rate. If Packet Loss is 0 for at least 10 minutes, PVEC stops operating and the Video Rate Used increases to match the Video Rate.

If only PVEC is enabled and the system detects Packet Loss, PVEC attempts to clean the image but the Video Rate is not adjusted. If only Dynamic Bandwidth is enabled and the system detects Packet Loss of 3% or more, the Video Rate is adjusted but PVEC does not clean the image.

You can view % Packet Loss, Video Rate, and Video Rate Used on the Call Statistics screen. Press **Info** on the remote control during a call to get to the Call Statistics screen.



## Quality of Service Settings

### To specify Quality of Service:

- 1 Do one of the following:
  - In the local interface, go to **System > Admin Settings > Network > IP > Quality of Service** (select  if necessary).
  - In the web interface, go to **Admin Settings > Network > IP Network > Quality of Service**.
- 2 Configure these settings on the Quality of Service screen:

Setting	Description
<b>Type of Service</b>	<p>Specifies your service type and lets you choose how to set the priority of IP packets sent to the system for video, audio, and far-end camera control:</p> <ul style="list-style-type: none"> <li>• <b>IP Precedence</b> — Represents the priority of IP packets sent to the system. The value can be between 0 and 5. If this setting is selected, enter the value in the <b>Type of Service Value</b> field.</li> <li>• <b>DiffServ</b> — Represents a priority level between 0 and 63. If this setting is selected, enter the value in the Type of Service Value field.</li> </ul>
<b>Type of Service Value</b>	<p>Specifies the IP Precedence or Diffserv value for Video, Audio, and Control.</p> <ul style="list-style-type: none"> <li>• Audio—audio RTP traffic and associated RTCP traffic</li> <li>• Video—video RTP traffic and associated RTCP traffic</li> <li>• Control—traffic on any of the following channels: H.323—H.225.0 Call Signaling, H.225.0 RAS, H.245, Far End Camera Control SIP—SIP Signaling, Far End Camera Control, Binary Floor Control Protocol (BFCP)</li> </ul>
<b>Maximum Transmission Unit Size</b>	<p>Specifies the Maximum Transmission Unit (MTU) size used in IP calls. If the video becomes blocky or network errors occur, packets may be too large; decrease the MTU. If the network is burdened with unnecessary overhead, packets may be too small; increase the MTU.</p>
<b>Enable PVEC</b>	<p>Allows the system to use PVEC (Polycom Video Error Concealment) if packet loss occurs.</p>
<b>Enable RSVP</b>	<p>Allows the system to use Resource Reservation Setup Protocol (RSVP) to request that routers reserve bandwidth along an IP connection path. Both the near site and far site must support RSVP in order for reservation requests to be made to routers on the connection path.</p>

Setting	Description
<b>Dynamic Bandwidth</b>	Specifies whether to let the system automatically find the optimum line speed for a call.
<b>Maximum Transmit Bandwidth</b>	Specifies the maximum transmit line speed between 64 kbps and the system's maximum line rate.
<b>Maximum Receive Bandwidth</b>	Specifies the maximum receive line speed between 64 kbps and the system's maximum line rate. <b>Note:</b> The 8 Mbps Line Rate feature is only for multipoint calls. It is not available as a maximum bandwidth.

## Configuring the System for Use with a Firewall or NAT

A firewall protects an organization's IP network by controlling data traffic from outside the network. Unless the firewall is designed to work with H.323 video conferencing equipment, you must configure the system and the firewall to allow video conferencing traffic to pass in and out of the network.

### Firewall Settings

Network Address Translation (NAT) network environments use private internal IP addresses for devices within the network, while using one external IP address to allow devices on the LAN to communicate with other devices outside the LAN. If your system is connected to a LAN that uses a NAT, you need to enter the **NAT Public (WAN) Address** so that your system can communicate outside the LAN.

#### To set up the system to work with a firewall or NAT:

- 1 Do one of the following:
  - In the local interface, go to **System > Admin Settings > Network > IP > Firewall** (select  if necessary).
  - In the web interface, go to **Admin Settings > Network > IP Network > Firewall**.

## 2 Configure these settings on the Firewall screen:

Setting	Description
<b>Fixed Ports</b>	<p>Lets you specify whether to define the TCP and UDP ports.</p> <ul style="list-style-type: none"> <li>If the firewall is not H.323 compatible, enable this setting. The Polycom HDX system assigns a range of ports starting with the TCP and UDP ports you specify. The system defaults to a range beginning with port 3230 for both TCP and UDP.</li> </ul> <p><b>Note:</b> You must open the corresponding ports in the firewall. You must also open the firewall's TCP port 1720 to allow H.323 traffic.</p> <ul style="list-style-type: none"> <li>If the firewall is H.323 compatible or the system is not behind a firewall, disable this setting.</li> </ul> <p>For IP you need 2 TCP ports per connection, 8 UDP ports per connection. For SIP you need TCP port 5060, 8 UDP ports per connection.</p> <p><b>Note:</b> With the introduction of ICE support to HDX systems, the range of fixed UDP ports increased from 56 to 112. The HDX system cycles through the available ports from call to call. After the system restarts, the first call begins with the first port number, either 49152 or 3230. Subsequent calls start with the last port used, for example, the first call uses ports 3230 to 3236, the second call uses ports 3236 to 3242, the third call uses ports 3242 through 3248, and so on.</p>
<b>TCP Ports UDP Ports</b>	<p>Lets you specify the beginning value for the range of TCP and UDP ports used by the system. The system automatically sets the range of ports based on the beginning value you set.</p> <p><b>Note:</b> You must also open the firewall's TCP port 1720 to allow H.323 traffic.</p>
<b>Enable H.460 Firewall Traversal</b>	<p>Allows the system to use H.460-based firewall traversal for IP calls. For more information, refer to <a href="#">H.460 Firewall/NAT Traversal</a> on page 2-24.</p>
<b>NAT Configuration</b>	<p>Lets you specify whether the system should determine the NAT Public WAN Address automatically.</p> <ul style="list-style-type: none"> <li>If the system is not behind a NAT or is connected to the IP network through a Virtual Private Network (VPN), select <b>Off</b>.</li> <li>If the system is behind a NAT that allows HTTP traffic, select <b>Auto</b>.</li> <li>If the system is behind a NAT that does not allow HTTP traffic, select <b>Manual</b>.</li> </ul>
<b>NAT Public (WAN) Address</b>	<p>Displays the address that callers from outside the LAN use to call your system. If you chose to configure the NAT manually, enter the NAT Public Address here.</p>

Setting	Description
<b>NAT is H.323 Compatible</b>	Specifies that the system is behind a NAT that is capable of translating H.323 traffic.
<b>Address Displayed in Global Directory</b>	Lets you choose whether to display this system's public or private address in the global directory.
<b>Enable SIP Keep-Alive Messages</b>	Specifies whether to regularly transmit keep-alive messages on the SIP signaling channel and on all RTP sessions that are part of SIP calls.  Keep-alive messages keep connections open through NAT/Firewall devices that are often used at the edges of both home and enterprise networks.



The **Enable SIP Keep-Alive Messages** setting is enabled by default. However, when an HDX system is deployed or registered in an Avaya SIP environment, Polycom recommends that you disable the setting to allow calls to connect fully.

In environments set up behind a firewall, firewall administrators can choose to limit access to TCP connections only. Although TCP is an accurate and reliable method of data delivery that incorporates error-checking, it is not a fast method. For this reason, real-time media streams often use UDP, which offers speed but not necessarily accuracy. Within an environment behind a firewall, where firewall administrator has restricted media access to TCP ports, calls can be completed using a TCP connection instead of UDP.



Systems deployed outside a firewall are potentially vulnerable to unauthorized access. Visit the Polycom Security section of the Knowledge Base at [support.polycom.com](http://support.polycom.com) for timely security information. You can also register to receive periodic email updates and advisories.

## H.460 Firewall/NAT Traversal

You can configure Polycom HDX systems to use standards-based H.460.18 and H.460.19 firewall traversal, which allows video systems to more easily establish IP connections across firewalls.

The following illustration shows how a service provider might provide H.460 firewall traversal between two enterprise locations. In this example the Polycom Video Border Proxy™ (VBP®) firewall traversal device is on the edge of the service provider network and facilitates IP calls between Polycom HDX systems behind different firewalls.

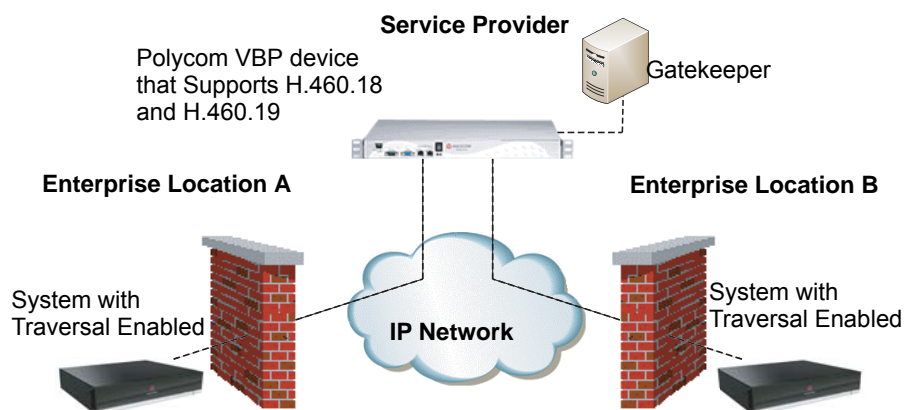

To use this traversal, Polycom HDX systems and firewalls must be configured as follows:

- 1 Enable firewall traversal on the Polycom HDX system.
  - a Go to System > Admin Settings > Network > IP > Firewall.
  - b Select Enable H.460 Firewall Traversal.
- 2 Register the Polycom HDX system to an external Polycom VBP device that supports the H.460.18 and H.460.19 standards.
- 3 Make sure that firewalls being traversed allow Polycom HDX systems behind them to open outbound TCP and UDP connections.
  - Firewalls with a stricter rule set should allow Polycom HDX systems to open at least the following outbound TCP and UDP ports: 1720 (TCP), 14085-15084 (TCP) and 1719 (UDP), 16386-25386 (UDP).
  - Firewalls should permit inbound traffic to TCP and UDP ports that have been opened earlier in the outbound direction.

### Basic Firewall/NAT Traversal Connectivity

Basic Firewall/NAT Traversal Connectivity allows HDX systems to connect to the SIP-based RealPresence solutions using the Acme Packet Net-Net family of Session Border Controllers (SBC). An HDX system connects to the Acme Packet Net-Net SBC as a remote enterprise endpoint. The remote enterprise endpoint is registered to the enterprise's SIP infrastructure and connects to an internal enterprise endpoint through the enterprise firewall.

For details about the use and configuration of the Acme Packet Net-Net SBC used in conjunction with this feature, refer to *Deploying Polycom Unified Communications in an Acme Packet Net-Net Enterprise Session Director Environment*.

HDX systems now also provide full mutual TLS support for SIP and XMPP Presence connections. Full mutual TLS support gives administrators the ability to identify and authenticate devices attempting to join conferences from outside the enterprise network.

## Connecting Polycom HDX Systems to ISDN or Other Networks

The following network interface modules are available for some Polycom HDX systems:

- **BRI** – Allows you to connect to an ISDN network using up to four BRI lines.
- **PRI** – Allows you to connect to an ISDN T1 or E1 network using a PRI line.
- **V.35/RS-449/RS-530** – Allows you to connect to third-party network equipment, including encryption equipment and RS-366 terminal adaptors and inverse multiplexers.

If you received a network interface module with your system, you may find it convenient to install it before positioning the system. Refer to the setup sheet that you received with the network interface module. Make sure that the system is powered off before you connect devices to it.

You will need the following network hardware.

Network Module	Requirements
<b>BRI</b>	<ul style="list-style-type: none"> <li>• NT-1 device, if the system will be connected to a network that provides a U interface. Do not use an NT-1 device if your PBX network provides an S/T interface.</li> <li>• Up to 4 BRI lines that will not be shared with other equipment.</li> </ul> <p>If you connect fewer than four BRI ports on the system's network interface module, connect them in ascending order, starting with port 1.</p>
<b>PRI</b> (North America and Japan)	<ul style="list-style-type: none"> <li>• PBX crossover cable, if required for your PBX.</li> <li>• Channel Service Unit (CSU) — not required if you connect the system to a PBX network.</li> <li>• PRI line.</li> </ul>

Network Module	Requirements
<b>PRI</b> (outside North America and Japan)	<ul style="list-style-type: none"> <li>75 W coaxial adapter, if the network connection is via a 75 W coaxial cable.</li> <li>PBX crossover cable, if required for your PBX.</li> <li>PRI line.</li> </ul>
<b>Serial</b> <b>V.35/RS-449/ RS-530</b> (with RS-366 dialing)	<ul style="list-style-type: none"> <li>Third-party network equipment and cables.</li> </ul> <p>Contact your network equipment vendor to obtain the appropriate cables for the equipment you connect to this interface. If you use only one cable, connect it to port 1 of the network interface module and to the lowest-numbered port of the data communications equipment.</p>

The following diagram shows a general view of how network interface modules are connected in Polycom HDX 9000 series systems.

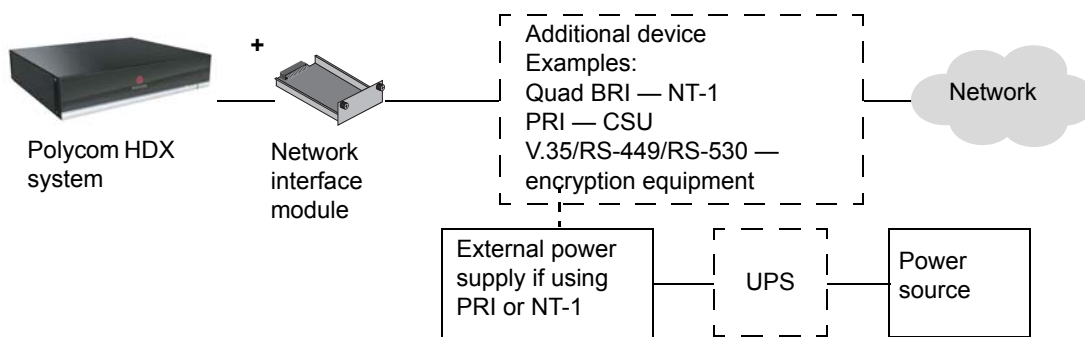

The following diagram shows a general view of how network interface modules are connected with Polycom HDX 8000 series, Polycom HDX 7000 series, and Polycom HDX 4000 series systems.

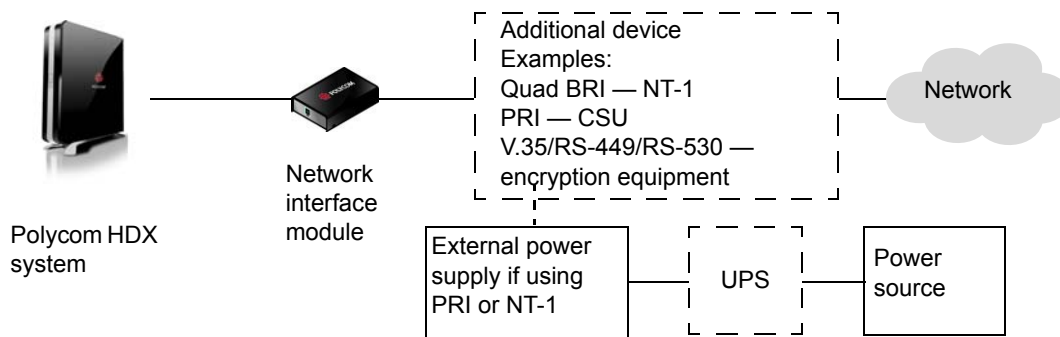

## Quad BRI Network Interface Status Lights

The network interface lights are located on the network interface module.

Interface Light State	Description
Lights are off	One of the following: <ul style="list-style-type: none"> <li>No power is going to the system.</li> <li>The system is not connected to the network.</li> <li>The system is not receiving a clock signal from the network.</li> <li>The system is restarting.</li> </ul>
Green light is on	The system is receiving a clock signal from the network.
Yellow light is on	The system is able to make a call.
Green and yellow lights are on	One of the following: <ul style="list-style-type: none"> <li>The system is receiving a software update.</li> <li>The system is operating normally.</li> </ul>

## PRI Network Interface Status Lights

The network interface lights are located on the network interface module.

Interface Light State	Description
Lights are off	No power to the system.
Red light is on or blinking	The system is not connected to the ISDN network, or a problem exists with the ISDN line.
Yellow light is on or blinking	A problem exists with the ISDN line.
Green light is on	The system is able to make and receive calls.



## Serial V.35/RS-449/RS-530 Network Interface Status Lights

The network interface lights are located on the network interface module.

Interface Light State	Description
Lights are off	One of the following: <ul style="list-style-type: none"> <li>No power to the system.</li> <li>The system is not communicating with the network.</li> <li>The system is restarting.</li> </ul>
Yellow light is on	The system is receiving a clock signal from the network (able to make a call).
Yellow and green lights are on	The system is in a call.

## Configuring ISDN and Other Network Interface Settings

You can configure a network interface option if the corresponding network interface module is installed. The system automatically detects the type of interface installed and displays only the required configuration screens.

### Configuring the BRI Network Interface



Polycom HDX systems do not support multilink BRI connections.

#### To configure the ISDN network interface settings:

- Do one of the following:
  - In the local interface, go to **System > Admin Settings > Network > ISDN** (select  if necessary).
  - In the web interface, go to **Admin Settings > Network > ISDN**.

## 2 Configure these settings:

Setting	Description
<b>Enable ISDN H.320</b>	Allows this system to make H.320 (ISDN) calls.
<b>Number of ISDN Channels to Dial in Parallel</b>	Specifies how many channels to dial at one time. You can specify up to 12 channels. If you experience network problems, decrease the number.
<b>Outside Line Dialing Prefix</b>	Specifies the ISDN dialing prefix used to call outside the network.
<b>Numbering Plan</b>	Select the appropriate numbering plan for your location, if it differs from the default.
<b>ISDN Voice Algorithm</b>	Specifies which voice algorithm ( <b>aLaw</b> or <b>uLaw</b> ) is used for ISDN voice calls. Do not change this setting unless you experience audio issues in all ISDN voice calls.
<b>ISDN Switch Protocols</b>	Specifies the protocol used by your network's switch.
<b>Auto BRI Configuration</b>	Allows the NI-1 or NI-2 switch to automatically configure the directory numbers and SPIDs. This setting is only available if you have selected the NI-1 or NI-2 switch protocol.
<b>Country, Country Code</b>	Displays the country selected as the system's location and the country code used for international calls to the system. To specify the system's location, go to <b>System &gt; Admin Settings &gt; General Settings &gt; Location</b> . The system automatically supplies the country code when you specify the country.
<b>Area Code</b>	Specifies the area code for this system's location.
<b>Directory Numbers</b>	Specifies the numbers assigned to the B1 and B2 channels for each BRI line. The two numbers for a line may be the same or different, depending on the switch protocol in use.
<b>Enable</b>	Specifies whether to enable the associated ISDN line. If you selected Standard ETSI Euro-ISDN protocol, you must enable all BRI lines that you expect to be active, and you must not enable lines that will not be connected. You may want to disable a particular line if there are problems with the line that generate continuing error messages.

- 3 If you have configured the ISDN switch protocol to be AT&T 5ESS Multipoint, NI-1, NI-2, or Nortel DMS-100, select  if necessary and enter the ISDN BRI SPIDs provided by your service provider.

After you enter the SPIDs, the system verifies them. If the system is unable to verify the SPIDs, make sure the system is connected and that the ISDN numbers you entered are correct.

If you do not have the SPIDs from your service provider, you can click **Start** to Auto Detect SPIDs.

## Configuring the PRI Network Interface



### Points to note about fractional PRI:

- Assigned channels must begin with channel 1, and the channel numbers must be consecutive.
- A D channel must be provided.
- Outbound call bandwidth must not exceed the available bandwidth.

### To configure the ISDN network interface settings:

- 1 Do one of the following:
  - In the local interface, go to **System > Admin Settings > Network > ISDN** (select  if necessary).
  - In the web interface, go to **Admin Settings > Network > ISDN**.
- 2 Configure these settings:

Setting	Description
<b>Enable ISDN H.320</b>	Allows this system to make H.320 (ISDN) calls.
<b>Area Code</b>	Specifies the area code for this system's location.
<b>PRI Video Number</b>	Specifies the ISDN number assigned to this system.
<b>Outside Line Dialing Prefix</b>	Specifies the ISDN dialing prefix used to call outside the network.
<b>BONDING: Calling Endpoint Uses the Original ISDN Number</b>	Specifies the use of a bonding standard. Incoming bonded calls will use the original number received to connect all remaining lines required for the call.
<b>Line Signaling</b>	Specifies the framing format in use. This setting is configurable for PRI E1, read-only for PRI T1.

Setting	Description
<b>External CSU</b> North America only	Specifies whether this system uses an external or internal Channel Service Unit (CSU).
<b>Line Build Out</b> PRI T1 only	For systems using an internal CSU, indicates the output attenuation in dB. Your service provider can provide you with these values.  For systems using an external CSU, indicates the length (in feet) of the RJ-45 cable that connects the PRI network interface module to the CSU.
<b>Switch Protocol</b>	Specifies the Network switch protocol. The available choices are determined by the system's country settings.  This setting is read-only for PRI E1, configurable for PRI T1. Your ISDN service provider can tell you which protocol your network uses. If you later change the <b>Country</b> setting, the PRI switch protocols available may also change, and you may be prompted to configure a different PRI switch protocol.
<b>ISDN Voice Algorithm</b>	Specifies which voice algorithm ( <b>aLaw</b> or <b>uLaw</b> ) is used for ISDN voice calls.  Do not change this setting unless you experience audio issues in all ISDN voice calls.
<b>Numbering Plan</b>	Select the appropriate numbering plan for your location, if it differs from the default.
<b>International Dialing Prefix</b>	Specify the dialing prefix needed for international calls.
<b>Call-by-Call</b>	Specifies a code that the system sends to the telephone company switch to request a special service, if such a code is required.  Consult your telephone service provider to determine the proper call-by-call value.
<b>Number of ISDN Channels to Dial in Parallel</b>	Specifies how many channels to dial at one time.  You can specify up to 12 channels. If you experience network problems, decrease the number.  Set this value to 1 for serial dialing. Serial dialing is not recommended unless you have trouble connecting calls using parallel dialing.
<b>Restore Defaults</b>	Resets all values on this screen. This does not affect other PRI settings.

Setting	Description
<b>PRI Line Type</b>	Displays read-only information about the system and its configuration.
<b>Number of Active Channels</b>	
<b>D Channel Location</b>	
<b>Network Mode</b>	
<b>Clock Source</b>	
<b>Terminal Endpoint ID</b> TEI	
<b>Line Termination</b> PRI E1 only	

- 3 Select  if necessary and select a channel to activate or deactivate it. Active channels are represented by a green icon, and inactive channels are represented by a gray icon.



Make sure that channels are activated and deactivated only by a knowledgeable network professional so that the system operates properly and can dial at the desired rates.

## Configuring the Serial V.35/RS-449/RS-530 Network Interface

To configure the V.35/RS-449/RS-530 network interface settings:

- Do one of the following:
  - In the local interface, go to **System > Admin Settings > Network > V.35/RS-449/RS-530** (select  if necessary).
  - In the web interface, go to **Admin Settings > Network > V.35/RS-449/RS-530**.
- Configure these settings:

Setting	Description
<b>Enable V.35/RS-449/RS-530</b>	Allows the system to connect to a terminal adapter using a V.35, RS-449, or RS-530 connection.
<b>V.35 Ports Used</b>	Specifies whether one or two lines are connected.

Setting	Description
<b>RS-366 Dialing</b>	Allows users to dial calls from this system. Clear this setting if this is a dedicated connection or if another device is used for dialing calls.
<b>Area Code</b> <b>Port 1</b> <b>Port 2</b>	Specifies the area code and number or numbers that other sites dial to reach this system. If this is a dedicated connection, leave these fields blank.
<b>Prefix</b>	Lets you specify the dialing prefix required to reach an outside line.
<b>Calling Profile</b>	Lets you specify what data communications equipment is connected to the network interface. The system automatically displays the default prefixes, suffixes, and calling speeds required by that device. If your device is not listed, select <b>Custom</b> .
<b>Speed</b>	Lets you define the prefixes or suffixes to use for each speed used in a Custom Calling Profile. For information about required prefixes and suffixes, refer to the documentation that came with the device. If you choose a predefined Calling Profile, this information is supplied for you.
<b>ST</b>	Lets you specify the signaling required by the external device connected to the system. Specify normal or inverted, as appropriate. In most cases, normal signaling is appropriate.
<b>RT</b>	
<b>RTS</b>	
<b>CTS</b>	If your system is connected to Ascend equipment, you may need to set CTS to <b>Ignore</b> .
<b>DSR</b>	
<b>DCD</b>	
<b>DTR</b>	
<b>Answer on DSR</b>	Specifies that the system should begin the call when it detects a DSR signal.
<b>Delayed DCD Hangup</b>	Specifies how long the system waits to end the call after a DCD signal is lost (for example, during a call via satellite).
<b>DTR Pulse Duration (secs)</b>	Specifies how long the DTR signal goes low after the far site hangs up. When the pulse is too short, the call may not clear. If your system is connected to ADTRAN equipment, you may need to adjust DTR pulse duration.
<b>Trigger Call on H.320 Data</b>	Specifies whether the call starts when H.320 data is detected at the V.35 interface while set for direct connect.

Setting	Description
<b>Crypto Resync</b>	Allows a Polycom HDX system connected to cryptographic equipment to signal when it loses video synchronization during a call. The cryptographic equipment can then resynchronize with the far site.
<b>Use RTS Signal for Resync Pulse</b>	Allows the system to send the resynchronization pulse on the RTS signal. Select this setting if your data communications equipment uses the V.35 or RS-449 capability of the serial V.35/RS-449/RS-530 network interface. <b>Note:</b> When you select this setting, the RTS no longer functions as the Request To Send signal.
<b>Time Between Pulses (sec)</b>	Specifies whether the system should set the time between resync pulses automatically or use the number of seconds you enter.
<b>Pulse Width (millisec)</b>	Specifies whether the system should set the pulse duration automatically or use the number of milliseconds you enter.
<b>Enable Broadcast Mode</b>	Enables support for H.331 broadcast transmissions from the Polycom HDX system. Broadcast mode enables the system to send video and audio to many other systems, such as large satellite networks.
<b>Enable People+Content</b>	Enables People+Content for broadcast mode.
<b>Video Format</b>	Specifies the resolution at which video is transmitted.
<b>Video Protocol</b>	Specifies the protocol used to transmit video. Choose the lowest protocol supported by all systems in the conference.
<b>Audio Protocol</b>	Specifies the protocol used to transmit audio.
<b>Frame Rate</b>	Specifies the frame rate to use.

## Connecting to an Analog Phone Line

You can connect an analog phone line to a Polycom HDX 9000 series, Polycom HDX 8000 series, Polycom HDX 4000, or Polycom HDX 4000 HD system to make regular telephone calls with the system or to add audio-only participants to video calls. The first analog phone or Voice Over ISDN connection does not count toward the number of sites in a call. Additional analog phone or Voice Over ISDN connections, as well as all H.323 audio-only and SIP audio-only connections, do count toward the number of sites in a call.

A connected SoundStation® IP 7000 conference phone can use this analog phone line to make regular telephone calls when the Polycom HDX system is configured as described in [Configuring Telephony](#) on page 2-36.



The country setting must be configured correctly on the Polycom HDX system to ensure proper operation of the phone line and to comply with local telephony regulations.

## Configuring Telephony

### To configure telephony options:

- 1 Do one of the following:
  - In the local interface, go to **System > Admin Settings > Network > Telephony** (select  if necessary).
  - In the web interface, go to **Admin Settings > Network > Telephony**.
- 2 Configure these settings on the Telephony screen:

Setting	Description
<b>Room Telephone Number</b>	Enter the telephone number of the room where the system is located.
<b>System Telephone Number</b> Polycom HDX 9000 series Polycom HDX 8000 series Polycom HDX 4000 HD Polycom HDX 4000	Specifies the analog phone number of the system, including country and area codes for the system's location.
<b>Outside Line Dialing Prefix</b> Polycom HDX 9000 series Polycom HDX 8000 series Polycom HDX 4000 HD Polycom HDX 4000	Specifies the dialing prefix used to call outside the network.

### To configure the analog phone line (POTS line):

- 1 Go to **System > Admin Settings > Network > Telephony** in the local interface or go to **Admin Settings > Network > Telephony** in the web interface.
- 2 Enter the **System Telephone Number** for the analog phone line.



- 3 Go to **System > Admin Settings > Network > Call Preference** in the local interface or go to **Admin Settings > Network > Call Preference** in the web interface.
- 4 **Enable Analog Phone.**
- 5 Go to **System > Admin Settings > Network > Call Preference > ** in the local interface or go to **Admin Settings > Network > Call Preference** in the web interface.
- 6 Add **Analog Phone** to the Phone Dialing Order on the Network Dialing screen.

## Configuring Call Preferences

Call preferences help you manage the network bandwidth used for calls. You can specify the default and optional call settings for outgoing calls. You can also limit the call speeds of incoming calls.

### To choose call preferences:

- 1 Do one of the following:
  - In the local interface, go to **System > Admin Settings > Network > Call Preference** (select  if necessary).
  - In the web interface, go to **Admin Settings > Network > Call Preference.**
- 2 Configure these settings on the Call Preference screen:

Setting	Description
<b>H.239</b>	Specifies standards-based People+Content data collaboration. Enable this option if you know that H.239 is supported by the far sites you will call. If callers experience issues when sharing content with other Polycom systems, disable this setting.
<b>IP H.323</b>	Allows the system to make IP calls.
<b>SIP</b>	Allows the system to use SIP when connecting IP calls.
<b>TIP</b> Polycom HDX 9006 Polycom HDX 8000 HD with Hardware Version B Polycom HDX 7000 HD with Hardware Versions C and D Polycom HDX 4500	The TIP setting is displayed only when the TIP option key has been installed.  When this setting is enabled, the HDX system uses TIP to communicate with another TIP-enabled system.  When the TIP setting is enabled, you can select <b>Preferred Speeds</b> for TIP.

Setting	Description
<p><b>Analog Phone</b>                      Polycom HDX 9000 series                      Polycom HDX 8000 series                      Polycom HDX 4000 HD                      Polycom HDX 4000</p>	<p>Allows the system to make voice-only calls to any phone using an analog phone line.</p>
<p><b>Transcoding</b>                      Polycom HDX 9006                      Polycom HDX 9004                      Polycom HDX 9002                      Polycom HDX 8000 series                      Polycom HDX 4500                      Polycom HDX 4000 HD</p>	<p>Allows the Polycom HDX system and the endpoints to adapt multiple environments for one multipoint call. Specifies whether the system allows each far-end system to connect at the best possible call rate and audio/video algorithm. If transcoding is disabled, the Polycom HDX system down-speeds all connections to the same call rate.</p> <p>When transcoding is enabled, the maximum resolution used in the call is SIF (352x240)/CIF (352x288), even if all of the endpoints in the call are capable of higher resolutions. The maximum transcoding resolution can be less than SIF/CIF, based on the number and type of endpoints used in the call, but the frame rate is always 30 fps.</p> <p>HDX systems support transcoding for audio and video algorithms, video resolution, and call rate. Polycom HDX 7000 HD systems support transcoding for audio algorithms and use speed matching for the call rate.</p>
<p><b>Diagnostic Mode</b></p>	<p>Enables a limited operating mode that uses H.261 for video and G.711 for audio. This mode provides administrators with a workaround for interoperability issues that cannot be resolved using other methods. The Diagnostic Mode setting stays in effect until you change it.</p> <p>Diagnostic Mode disables many system features such as content sharing, far end camera control, and advanced audio and video algorithms. Use Diagnostic Mode only when calling systems that do not operate properly with these advanced features.</p> <p><b>Note:</b> The name of this setting changed from Basic Mode to Diagnostic Mode.</p>
<p><b>ISDN Gateway</b></p>	<p>Allows users to place IP-to-ISDN calls through a gateway.</p>
<p><b>IP Gateway</b></p>	<p>Allows users to place ISDN-to-IP or IP-to-IP calls through a gateway.</p>

Setting	Description
<b>Maximum Resolution</b> Polycom HDX 7000 Polycom HDX 6000 series	<p>Polycom HDX 7000: Allows you to send and receive 720p people video at 15 fps for NTSC and 12.5 fps for PAL. When this setting is enabled, the system displays only two windows in Dual Monitor Emulation (DME) mode.</p> <p>Polycom HDX 6000 series: Allows you to send and receive 1080p people video. When this setting is enabled, Camera 2 is automatically set to People. You can use People+Content IP to send content, but sending content will result in reduced People video quality.</p> <p>For more information about maximum resolution and call speeds, refer to <a href="#">Appendix C, Call Speeds and Resolutions</a>.</p>
<b>V.35/RS-449/RS-530</b>	<p>Allows the system to make calls through your third-party network equipment.</p> <p>This selection is only available when the system has a V.35/RS-449/RS-530 network module installed.</p>
<b>ISDN H.320</b>	<p>Allows the system to make ISDN calls.</p> <p>This selection is only available when the system has ISDN networking capability.</p>
<b>Voice Over ISDN</b>	<p>Allows the system to make voice-only calls to phones connected to an ISDN network, such as an organization's PBX. The ISDN BRI must be provisioned to support voice calls.</p> <p>This selection is only available when the system has ISDN networking capability.</p>
<b>Preferred Dialing Method</b>	<p>Specifies the preferred method for dialing various call types. If set to <b>Auto</b>, calls use the configured Dialing Order. If set to <b>Manual</b>, the system prompts the user to select the call type from a list when placing a call.</p> <p><b>Notes:</b></p> <ul style="list-style-type: none"> <li>• Call rollover does not occur for contacts called as part of a group. If preferred dialing is set to <b>Auto</b>, each contact in a group is called using the first available call type it has that matches the Dialing Order set on the system. If preferred dialing is set to <b>Manual</b>, each contact is called using the first available call type in this order: H.323, SIP, ISDN/V.35, gateway H.320, gateway H.323, Voice Over ISDN, then analog phone.</li> <li>• When using the Polycom Touch Control, the preferred dialing method must be set to <b>Auto</b>.</li> </ul>

Setting	Description
<p><b>Call Preference</b>                      Polycom HDX 9000 series                      Polycom HDX 8000 series                      Polycom HDX 7000 series                      Polycom HDX 4000 series</p>	<p>Specifies whether the Polycom HDX system uses the Video Dialing Order or the Phone Dialing Order first when placing calls. This setting is available only when both video and phone call types are available.</p>
<p><b>Video Dialing Order</b></p>	<p>Specifies how the system places video calls to directory entries that have more than one type of number. It also specifies how the system places video calls from the Place a Call screen when the call type selection is either unavailable or set to <b>Auto</b> or <b>Video</b>. If a call attempt does not connect, the system tries to place the call using the next call type in the list.</p> <p>This setting is available only when <b>Preferred Dialing Method</b> is set to <b>Auto</b>.</p> <p>For more information, refer to <a href="#">Configuring Dialing Order Settings</a> on page 2-41.</p>
<p><b>Phone Dialing Order</b>                      Polycom HDX 9000 series                      Polycom HDX 8000 series                      Polycom HDX 7000 series                      Polycom HDX 4000 HD                      Polycom HDX 4000</p>	<p>Specifies how the system places audio calls to directory entries that have more than one type of number. It also specifies how the system places audio calls from the Place a Call screen when the call type selection is either unavailable or set to <b>Auto</b> or <b>Phone</b>. If a call attempt does not connect, the system tries to place the call using the next call type in the list.</p> <p>This setting is available only when <b>Preferred Dialing Method</b> is set to <b>Auto</b>.</p> <p>For more information, refer to <a href="#">Configuring Dialing Order Settings</a> on page 2-41.</p>
<p><b>Preferred Speed for Placing Calls</b>  <b>IP Calls</b>  <b>SIP (TIP) Calls</b></p>	<p>Determines the speeds to use for IP or SIP (TIP) calls from this system when:</p> <ul style="list-style-type: none"> <li>• The Call Quality selection is either unavailable or set to <b>Auto</b> on the Place a Call screen</li> <li>• The call is placed from the directory</li> </ul> <p>If the far-site system does not support the selected speed, the system automatically negotiates a lower speed.</p> <p>Users cannot specify a call speed when placing calls from the Polycom Touch Control.</p> <p>The <b>SIP (TIP) Calls</b> setting is available only when the <b>TIP</b> setting is enabled.</p>

Setting	Description
<b>Maximum Speed for Receiving Calls</b> <b>IP Calls</b> <b>SIP (TIP) Calls</b>	<p>Allows you to restrict the bandwidth used when receiving IP or SIP (TIP) calls.</p> <p>If the far site attempts to call the system at a higher speed than selected here, the call is renegotiated at the speed specified in this field.</p> <p>The <b>SIP (TIP) Calls</b> setting is available only when the <b>TIP</b> setting is enabled.</p>
<b>ISDN Video Calls (H.320)</b> Polycom HDX 9000 series Polycom HDX 8000 series Polycom HDX 7000 series Polycom HDX 6000 series Polycom HDX 4000 HD Polycom HDX 4000	<p>Determines the speeds that will be used for ISDN video calls from this system when:</p> <ul style="list-style-type: none"> <li>The Call Quality selection is either unavailable or set to <b>Auto</b> on the Place a Call screen</li> <li>The call is placed from the directory</li> </ul> <p>If the far-site system does not support the selected speed, the system automatically negotiates a lower speed.</p>
<b>International ISDN Calls</b> Polycom HDX 9000 series Polycom HDX 8000 series Polycom HDX 7000 series Polycom HDX 6000 series Polycom HDX 4000 HD Polycom HDX 4000	<p>Determines the speeds that will be used for International ISDN video calls from this system when:</p> <ul style="list-style-type: none"> <li>The Call Quality selection is either unavailable or set to <b>Auto</b> on the Place a Call screen</li> <li>The call is placed from the directory</li> </ul> <p>If the far-site system does not support the selected speed, the system automatically negotiates a lower speed.</p>

- 3 Select  if necessary to go to the Call Speeds screen and specify the call speeds to make available to users, if you are allowing them to choose speeds on a call-by-call basis.



To make the enabled call types available on the Place a Call screen, you must enable the **Call Quality** setting described on page 7-6.

## Configuring Dialing Order Settings

If the call type on the home screen is set to a specific call type, the system does not attempt to place the call using a different call type, even if other types are listed in Video Dialing Order or Phone Dialing Order.

You can configure the Polycom HDX system so that users can choose to place IP-to-ISDN or ISDN-to-IP calls through a gateway.

**To allow users to place an IP-to-ISDN call through a gateway:**

- 1 Make sure the system is registered with a gatekeeper.
- 2 Do one of the following:
  - In the local interface, go to **System > Admin Settings > Network > Call Preference** and enable **ISDN Gateway**.
  - In the web interface, go to **Admin Settings > Network > Call Preference** and enable **ISDN Gateway**.
- 3 If you want to allow users to place IP-to-ISDN calls through a gateway when calling from the directory, do one of the following:
  - On the Network Dialing screen, set **Preferred Dialing Method** to **Auto** and select **ISDN Gateway** as the first choice under **Video Dialing Order**. With this configuration, IP-to-ISDN calls placed from the directory will be placed through a gateway if an ISDN number exists. If the system is not registered with PathNavigator, the gateway suffix/prefix must be configured for the corresponding speed on the Gateway Setup screen at **System > Admin Settings > Network > IP > H.323 Settings**. If the system is registered with PathNavigator, the necessary suffix is added automatically when a call is placed.
  - On the Network Dialing screen, set **Preferred Dialing Method** to **Manual**. With this configuration, users can select **ISDN Gateway** from the list of call types that appears when placing a call from the directory.

**To allow users to place an ISDN-to-IP call through a gateway:**

- 1 Go to **System > Admin Settings > Network > Call Preference** in the local interface or **Admin Settings > Network > Call Preference in the web interface**.
- 2 Enable **IP Gateway**.
- 3 If you want to allow users to place ISDN-to-IP or IP-to-IP calls through a gateway when calling from the directory, do one of the following:
  - On the Network Dialing screen, set **Preferred Dialing Method** to **Auto** and select **IP Gateway** as the first choice under **Video Dialing Order**. With this configuration, ISDN-to-IP calls placed from the directory will be placed through a gateway if an ISDN number and IP extension exist. IP-to-IP calls placed from the directory will be placed through a gateway if an IP address and IP extension exist.
  - On the Network Dialing screen, set **Preferred Dialing Method** to **Manual**. With this configuration, users can select **IP Gateway** from the list of call types that appears when placing a call from the directory.

# Monitors and Cameras

## Connecting Monitors

Make sure that the system is powered off before you connect devices.

### Connecting Monitors to Polycom HDX 9000 Series Systems

The following table shows how you can connect monitors to a Polycom HDX 9000 series system.

Video Output Number	Connector	Output Formats
1	Two BNC (not available on Polycom HDX 9006)	S-Video, Composite
	DVI-I	VGA, DVI*, Component
2	Two BNC (not available on Polycom HDX 9006)	S-Video, Composite
	DVI-I	VGA, DVI*, Component
3 (VCR/DVD Player)	BNC (two)	S-Video, Composite
4 (Content), Polycom HDX 9004	DVI-I	VGA, DVI*, Component
* Select DVI if the monitor is connected using HDMI or DVI-D.		

For Monitor 1 and Monitor 2, the system may provide both dual BNC connectors and a DVI-I connector. Only one at a time is active, based on the output format configured for that monitor.

The Polycom HDX system user interface is displayed on Monitor 1. If you cannot see the user interface on the system's monitor, refer to [Changing the Video Format](#) on page 12-7.

## Connecting Monitors to Polycom HDX 8000 Series or Polycom HDX 7000 Series Systems

The following table shows how you can connect monitors to a Polycom HDX 8000 series system or Polycom HDX 7000 system with Hardware Version A, B, or C.

Video Output Number	Connector	Output Formats
1	DVI-I	VGA, DVI*, Component
2	DVI-I	VGA, DVI*, Component
3 (VCR/DVD Player)	S-Video	S-Video, Composite
* Select DVI if the monitor is connected using HDMI or DVI-D.		

The following table shows how you can connect monitors to a Polycom HDX 7000 system with Hardware Version D.

Video Output Number	Connector	Output Formats
1	DVI-I	VGA, DVI*, Component
2	DVI-I	VGA, DVI*, Component
* Select DVI if the monitor is connected using HDMI or DVI-D.		

The Polycom HDX system user interface is displayed on Monitor 1. If you cannot see the user interface on the system's monitor, refer to [Changing the Video Format](#) on page 12-7.

## Connecting a Monitor to Polycom HDX 6000 Series Systems

The following table shows how you can connect a monitor to a Polycom HDX 6000 series system.

Video Output	Connector	Output Formats
Monitor	HDMI	HDMI, DVI
* Select DVI if the monitor is connected using DVI-D.		

When the video output format is set to HDMI, you can get audio output from the HDMI or RCA connectors. When the video output format is set to DVI, you can get audio output from the RCA connectors only.

If you cannot see the user interface on the system's monitor, refer to [Changing the Video Format](#) on page 12-7.



## Connecting a Monitor to a Polycom HDX 4500 System

The following table shows how you can connect a monitor to a Polycom HDX 4500 system. Note that DVI is supported for Video-1 only on the monitor that Polycom provides.

Video Output Number	Connector	Output Formats
1	DVI-I	DVI
2 <sup>1</sup>	DVI-I	VGA, DVI <sup>2</sup> , Component
<sup>1</sup> You can use Output 2 for a digital video recorder (DVR), but not with S-Video. <sup>2</sup> Select DVI if the monitor is connected using HDMI or DVI-D.		

## Using a Polycom HDX 4000 Series System Monitor with a Computer

You can use the Polycom HDX 4000 series system monitor as a high-resolution display for your computer, as shown on the quick start guide.

### To use the Polycom HDX 4000 series system monitor as the monitor for a computer:



- 1 Connect a cable from the DVI connector on the back of the Polycom HDX 4000 system to the DVI or VGA connector on your computer.
- 2 To use the system's built-in speakers for your computer's audio, connect the 3.5 mm audio cable from your computer to the audio input connector on the Polycom HDX 4000 series system.



## Configuring Monitor Settings

### To configure monitors:

- 1 Do one of the following:
  - In the local interface, go to **System > Admin Settings > Monitors > Monitors** (select  if necessary).
  - In the web interface, go to **Admin Settings > Monitors**.

2 Configure these settings on the Monitors screen:

Setting	Description
<b>Monitor 1</b>	<p>Specifies the monitor's aspect ratio determined by the HDX system:</p> <ul style="list-style-type: none"> <li>• <b>4:3</b> — Regular TV monitor</li> <li>• <b>16:9</b> — Wide-screen monitor</li> </ul>
<b>Video Format</b>	<p>Specifies the monitor's format. For a list of available formats, refer to the information for your system in <a href="#">Connecting Monitors</a> on page 3-1.</p> <p><b>Note:</b> If you use <b>16:9</b>, you might also need to set up the monitor for full-screen display if the monitor does not automatically do so. In the monitor's setup menu, choose the setting that stretches the picture uniformly without clipping the edges, which is usually called Full, Wide screen, or 16x9.</p> <p>Use this setting:  Not this setting: </p>
<b>Resolution</b>	<p>Specifies the resolution for the monitor.</p>
<b>Output Upon Screen Saver Activation</b>	<p>Specifies the screen saver output for Monitor 1.</p> <p>Specifies whether black video or no signal is sent to the monitor when the system goes to sleep and the screen saver activates.</p> <p>Select <b>Black</b> if you want to display screen saver text. This is the recommended setting to prevent burn-in for TV monitors.</p> <p>Select <b>No Signal</b> if you want the display to react as if it is not connected when the system goes to sleep. This is the recommended setting for VGA monitors and projectors, as well as Polycom HDX media carts with 1080p displays.</p>

Setting	Description
<p><b>PIP</b></p> <p>Polycom HDX 9006  Polycom HDX 9004  Polycom HDX 9002  Polycom HDX 9001  Polycom HDX 8000 HD  Polycom HDX 7000 HD  Polycom HDX 7000  Polycom HDX 6000 HD</p>	<p>Specifies PIP (Picture-in-Picture) behavior:</p> <ul style="list-style-type: none"> <li>• <b>On</b> — The PIP window stays on for the duration of the call.</li> <li>• <b>Camera</b> — The PIP window is displayed when the call is first connected and when a user moves the camera, uses presets, or switches to a different camera source.</li> <li>• <b>Off</b> — The PIP window is not displayed during the call.</li> </ul> <p><b>Note:</b> PIP settings are also available in the User Settings screen.</p> <p>Users can turn the PIP on or off and change its location on the screen using  <b>Display</b> on the remote control. If the Polycom HDX system is paired with a Polycom Touch device, users can turn the PIP on or off and change its location by touching <b>Layout</b>, and selecting the desired layout from the Call screen of the Polycom Touch Control.</p>
<p><b>Display Near Video</b>  <b>Display Far Video</b>  <b>Display Content</b></p> <p>Polycom HDX 9006  Polycom HDX 9004  Polycom HDX 9002  Polycom HDX 9001  Polycom HDX 8000 HD  Polycom HDX 7000 HD  Polycom HDX 7000  Polycom HDX 4000 HD  Polycom HDX 4000</p>	<p>Specifies whether to display near video, far video, and content on this monitor.</p>
<p><b>Dual Monitor Emulation</b></p> <p>Polycom HDX 9006  Polycom HDX 9004  Polycom HDX 9002  Polycom HDX 9001  Polycom HDX 8000 HD  Polycom HDX 7000 HD  Polycom HDX 7000  Polycom HDX 4000 HD  with Hardware Version C</p>	<p>Specifies whether the system can show multiple views on a single display. If content is being viewed, different views can be displayed by pressing  <b>Display</b> on the remote control.</p> <p>If the Polycom HDX system is paired with a Polycom Touch device and content is being viewed, touch <b>Layout</b>, and select the desired view from the Call screen of the Polycom Touch Control.</p> <p>For more information, refer to <a href="#">Using Dual Monitor Emulation</a> on page 3-9.</p>

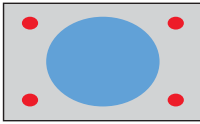
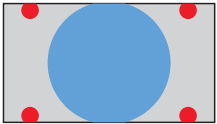
Setting	Description
<p><b>Monitor 2</b></p> <p>Polycom HDX 9006                      Polycom HDX 9004                      Polycom HDX 9002                      Polycom HDX 9001                      Polycom HDX 8000 HD                      Polycom HDX 7000 HD                      Polycom HDX 7000                      Polycom HDX 4500</p>	<p>Specifies the second monitor's aspect ratio:</p> <ul style="list-style-type: none"> <li>• <b>Off</b> — Select if you do not have a second monitor.</li> <li>• <b>4:3</b> — Select if you are using a regular TV monitor as the second monitor.</li> <li>• <b>16:9</b>—Select if you are using a wide-screen monitor as the second monitor. On the monitor, select the display mode that uniformly stretches the video from side to side, which is usually called Full, Wide screen, or 16x9.</li> </ul>
<p><b>Video Format</b></p> <p>Polycom HDX 9006                      Polycom HDX 9004                      Polycom HDX 9002                      Polycom HDX 9001                      Polycom HDX 8000 HD                      Polycom HDX 7000 HD                      Polycom HDX 7000                      Polycom HDX 4500</p>	<p>Specifies the monitor's format. For a list of available formats, refer to the information for your system in the previous section of this chapter, <a href="#">Connecting Monitors</a> on page 3-1.</p> <p><b>Note:</b> If you select <b>16:9</b>, you will also need to set up the monitor for full-screen display. In the monitor's setup menu, choose the setting that stretches the picture uniformly without clipping the edges, which is usually called Full, Wide screen, or 16x9.</p> <p>Use this setting:       Not this setting: </p>
<p><b>Resolution</b></p>	<p>Specifies the resolution for the monitor.</p>
<p><b>Output Upon Screen Saver Activation</b></p>	<p>Specifies the screen saver output for Monitor 2.</p> <p>Specifies whether black video or no signal is sent to the monitor when the system goes to sleep and the screen saver activates.</p> <p>Select <b>Black</b> if you want to display black video. This is the recommended setting to prevent burn-in for TV monitors.</p> <p>Select <b>No Signal</b> if you want the display to react as if it is not connected when the system goes to sleep. This is the recommended setting for VGA monitors and projectors, as well as Polycom HDX media carts with 1080 displays.</p>
<p><b>Display Near Video Display Far Video Display Content</b></p> <p>Polycom HDX 9006                      Polycom HDX 9004                      Polycom HDX 9002                      Polycom HDX 9001                      Polycom HDX 8000 HD                      Polycom HDX 7000 HD                      Polycom HDX 7000                      Polycom HDX 4000 HD                      Polycom HDX 4000</p>	<p>Specifies whether to display near video, far video, and content on this monitor.</p>

Setting	Description
<p><b>Monitor 3 (VCR/DVD)</b></p> <p>Polycom HDX 9006  Polycom HDX 9004  Polycom HDX 9002  Polycom HDX 9001  Polycom HDX 8000 HD  Polycom HDX 7000 HD  Polycom HDX 7000</p>	<p>Specifies the aspect ratio for recording.</p> <ul style="list-style-type: none"> <li>• <b>Off</b> — Select if you do not have a VCR or DVD player connected to record video conferences.</li> <li>• <b>4:3</b> — Select to record for playback on a standard monitor.</li> <li>• <b>16:9</b>—Select to record for playback on a wide-screen monitor, if your recording device has this capability.</li> </ul> <p><b>Note</b> (Polycom HDX 9006, Polycom HDX 8000 series, and Polycom HDX 7000 series systems): The video format and resolution of Monitor 1 and Monitor 2 affect the output sent to Monitor 3, as follows:</p> <ul style="list-style-type: none"> <li>• When Monitor 1 and Monitor 2 are both on and are both set to VGA (1920 x 1080 or 1280 x 720), DVI (1920 x 1080 or 1280 x 720), or Component (NTSC only), you can choose either Monitor 1 Image or Monitor 2 Image as the output to Monitor 3 (VCR/DVD).</li> <li>• When Monitor 1 and Monitor 2 are both on but only one of them is set to VGA (1920 x 1080 or 1280 x 720), DVI (1920 x 1080 or 1280 x 720), or Component (NTSC only), the output to Monitor 3 (VCR/DVD) is set to the image from that monitor.</li> <li>• When Monitor 1 and Monitor 2 are both on but neither is set to VGA (1920 x 1080 or 1280 x 720), DVI (1920 x 1080 or 1280 x 720), or Component, Monitor 3 is disabled.</li> <li>• If Monitor 2 is disabled, Monitor 3 is fully configurable and independent of Monitor 1.</li> </ul>
<p><b>Video Format</b></p> <p>Polycom HDX 9006  Polycom HDX 9004  Polycom HDX 9002  Polycom HDX 9001  Polycom HDX 8000 HD  Polycom HDX 7000 HD  Polycom HDX 7000</p>	<p>Specifies the VCR or DVD player's format. For a list of available formats, refer to the information for your system in the previous section of this chapter, <a href="#">Connecting Monitors</a> on page 3-1.</p>
<p><b>VCR/DVD Record Source</b></p> <p>Polycom HDX 9006  Polycom HDX 9004  Polycom HDX 9002  Polycom HDX 9001  Polycom HDX 8000 HD  Polycom HDX 7000 HD  Polycom HDX 7000</p>	<p>Specifies the video source to be recorded to videotape or DVD.</p> <p>If <b>Far</b> is enabled, the recorded video will switch to the current far site speaker. If both <b>Near</b> and <b>Far</b> are enabled, the recorded video will switch between near and far sites depending on the current speaker. If <b>Content</b> is enabled, any content sent during the call is recorded.</p>

Setting	Description
<p><b>Output Upon Screen Saver Activation</b></p> <p>Polycom HDX 9006                      Polycom HDX 9004                      Polycom HDX 9002                      Polycom HDX 9001                      Polycom HDX 8000 HD                      Polycom HDX 7000 HD                      Polycom HDX 7000</p>	<p>Specifies the screen saver output for a VCR or DVD player.</p> <p>Specifies whether black video or no signal is sent to the VCR or DVD player when the system goes to sleep and the screen saver activates.</p> <p>Select <b>Black</b> if you want to send black video.</p> <p>Select <b>No Signal</b> if you want the VCR or DVD player to react as if it is not connected when the system goes to sleep.</p> <p><b>Note</b> (Polycom HDX 8000 series and Polycom HDX 7000 series systems): When VCR/DVD Record Source is set to <b>Monitor 1 Image</b> or <b>Monitor 2 Image</b>, the screen saver setting for Monitor 3 is the same as for that other monitor.</p>
<p><b>Monitor 4</b></p> <p>Polycom HDX 9004</p>	<p>Specifies the fourth monitor's aspect ratio:</p> <ul style="list-style-type: none"> <li>• <b>Off</b> — Select if you do not have a fourth monitor.</li> <li>• <b>4:3</b> — Select if you are using a regular TV monitor as the fourth monitor.</li> <li>• <b>16:9</b>—Select if you are using a wide-screen monitor as the fourth monitor. On the monitor, select the display mode that uniformly stretches the video from side to side, which is usually called Full, Wide screen, or 16x9.</li> </ul>
<p><b>Video Format</b></p> <p>Polycom HDX 9004</p>	<p>Specifies the format for Monitor 4. For a list of available formats, refer to the information for your system in the previous section of this chapter, <a href="#">Connecting Monitors</a> on page 3-1.</p> <p><b>Note:</b> If you use <b>16:9</b>, you might also need to set up the monitor for full-screen display. In the monitor's setup menu, choose the setting that stretches the picture uniformly without clipping the edges, which is usually called Full, Wide screen, or 16x9.</p>
<p><b>Resolution</b></p> <p>Polycom HDX 9004</p>	<p>Specifies the resolution for Monitor 4.</p>
<p><b>Output Upon Screen Saver Activation</b></p> <p>Polycom HDX 9004</p>	<p>Specifies the screen saver output for Monitor 4:</p> <p>Specifies whether black video or no signal is sent to the monitor when the system goes to sleep and the screen saver activates.</p> <p>Select <b>Black</b> if you want to display black video. This is the recommended setting to prevent burn-in for TV monitors.</p> <p>Select <b>No Signal</b> if you want the display to react as if it is not connected when the system goes to sleep. This is the recommended setting for VGA monitors and projectors, as well as Polycom HDX media carts with 1080p displays.</p>

Setting	Description
<b>Display Content</b> Polycom HDX 9004	Specifies that content is displayed on Monitor 4.
<b>People Video Adjustment, Content Video Adjustment</b>	<p>Specifies the adjustment made to people video and content video images.</p> <ul style="list-style-type: none"> <li>• <b>None</b>—Preserves the aspect ratio of the source video. The image is scaled (if necessary) to the largest supported resolution that fits on the display without cropping. Extra areas on the display are filled with black borders.</li> <li>• <b>Stretch</b>—Does not preserve aspect ratio. The image is scaled horizontally and vertically to exactly match the resolution of the display.</li> <li>• <b>Zoom</b>—Preserves the aspect ratio of the source video. The image is scaled to exactly match one of the display dimensions while matching or exceeding the other display dimension. The image is centered and cropped.</li> </ul>
<b>Display Icons in a Call</b>	Specifies whether to display all on-screen graphics, including icons and help text, during calls.
<b>Screen Saver Wait Time</b>	<p>Specifies how long the system remains awake during periods of inactivity. The default is 3 minutes. If the system requires users to log in, the screen saver timeout also logs out the current user.</p> <p>Setting this option to <b>Off</b> prevents the system from going to sleep. To prevent image burn-in, specify 3 minutes or less.</p> <p><b>Note:</b> The screen saver feature is disabled during the setup wizard. To prevent image burn-in, complete the setup wizard promptly.</p>

## Using Dual Monitor Emulation

Dual Monitor Emulation is available on Polycom HDX 9000 series, Polycom HDX 8000 series, Polycom HDX 7000 series, Polycom HDX 6000 series, Polycom HDX 4500, and Polycom HDX 4000 HD with Hardware Version C systems.



For the Polycom HDX 4500 system, Dual Monitor Emulation is an internal feature. The feature does not appear with the **Monitor** settings and it has no settings you can change.

Dual Monitor Emulation is designed for rooms or offices with one monitor only. Users see both near and far sites on one monitor in two different windows. During presentations, users see content *and* the near and far sites.

What you see during a call can depend on factors such as the Polycom HDX system monitor configuration, the number of sites in the call, and whether content is being shared.



The following systems show only two windows in Dual Monitor Emulation: Polycom HDX 9006, Polycom HDX 8000 HD with Hardware Version B, Polycom HDX 7000 series with Hardware Version C or D, Polycom HDX 6000 series, Polycom HDX 4500, and Polycom HDX 4000 HD with Hardware Version C.

## Examples of Dual Monitor Emulation

### Call connects

Near and far site are the same size and appear side by side.

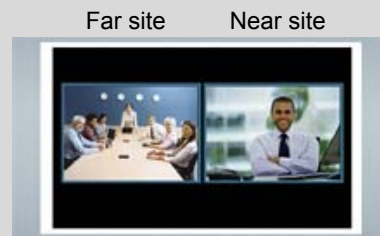

### Near site presses Display

Size of far site window increases.



### Near site presents to far site

Content, near site, and far site are displayed in dual monitor emulation mode.



## Using Dual Monitor Emulation in a Call

During calls using Dual Monitor Emulation, users can press the  **Display** button on the remote control to scroll through the following screen layouts:



For information about using Dual Monitor Emulation in a call when the Polycom HDX system is paired with a Polycom Touch Control, refer to the *User's Guide for Polycom HDX Systems and Polycom Touch Control Device*.

- 1 Near and far sites, same size, side by side
- 2 Far site big, near site small
- 3 Near site big, far site small



4 Near site, full screen





5 Far site, full screen

The last layout viewed is used for the next call.

## Configuring Multipoint Viewing Modes

### To configure multipoint viewing modes:

- 1 Do one of the following:
  - In the local interface, go to **System > Admin Settings > Monitors > Multipoint Setup**.
  - In the web interface, go to **Admin Settings > Monitors > Multipoint Setup**.
- 2 Configure this setting:

Setting	Description
<b>Multipoint Mode</b>	<p>Video images from multiple sites can be automatically combined on one screen in a display known as <i>continuous presence</i>.</p> <div style="display: flex; align-items: flex-start;"> <div style="margin-right: 10px;">  </div> <div> <p><b>Auto</b> — The view switches between continuous presence and full screen, depending on the interaction between the sites.</p> <p>If multiple sites are talking at the same time, continuous presence is used. If one site speaks uninterrupted for at least 15 seconds, that site appears in presentation mode.</p> </div> </div> <div style="display: flex; align-items: flex-start; margin-top: 10px;"> <div style="margin-right: 10px;">  </div> <div> <p><b>Discussion</b> — Multiple sites are displayed in continuous presence. The current speaker's image is highlighted.</p> </div> </div> <div style="display: flex; align-items: flex-start; margin-top: 10px;"> <div style="margin-right: 10px;">  </div> <div> <p><b>Presentation</b> — The speaker sees continuous presence while the other sites see the speaker in full screen.</p> </div> </div> <div style="display: flex; align-items: flex-start; margin-top: 10px;"> <div style="margin-right: 10px;">  </div> <div> <p><b>Full Screen</b> — The site that is speaking is shown in full screen to all other sites. The current speaker sees the previous speaker.</p> </div> </div>

What you see during a multipoint call can depend on factors such as the Polycom HDX system monitor configuration, the number of sites in the call, the speed of the call, whether content is shared, and whether dual monitor emulation is used. The multipoint viewing mode on the host system is the mode used in the call.

During SD multipoint calls that include more than four sites, the Polycom HDX system can display the site that is hosting the conference along with the last three sites where people spoke. In HD multipoint calls, the Polycom HDX 9004 can display up to eight sites in continuous presence. For more information about HD and SD multipoint, refer to [HD and SD Multipoint Calls](#) on page 3-38.

If Polycom StereoSurround™ is enabled, multipoint calls in continuous presence provide a stereo effect. This stereo effect matches a far site's audio to its location on the display.



**Points to note about Discussion mode:**

- To correctly display Discussion mode, you must select both **Near** and **Far** video sources for Monitor 1.
- To correctly display Discussion mode for multipoint calls with three far sites shown on two monitors, you must select both **Near** and **Far** video sources for Monitor 1, and clear **Far** for Monitor 2.
- You cannot display Discussion mode on Monitor 2.
- For multipoint calls using a Polycom MGC bridge, set **People Video Adjustment** and **Content Video Adjustment** to **None** in order to properly display Discussion mode on a 16x9 monitor.

To select video sources, use the **Display Near Video**, **Display Far Video**, and **Display Content** settings on the Monitors screens.

For more information about multipoint calls, refer to [Experiencing High-Definition Video Conferencing](#) on page 3-37 and [Configuring Multipoint Calling](#) on page 6-3.

## Adjusting the Monitor's Color Balance, Sharpness, and Brightness

In most cases, the monitor you connect to your Polycom HDX 9000 series, Polycom HDX 8000 series, or Polycom HDX 7000 series system may be set to a configuration that is appropriate for video conferencing applications. Depending on your environment and model of monitor, however, the video may exhibit one of these problems:

- Picture is too dark or too bright
- Colors appear faded
- Picture has too much of one color — for example, the picture may appear greenish
- Picture has blocky or softened edge detail

If you notice any of these problems, adjust the monitor's color balance, sharpness, and brightness until the display seems acceptable. Use the video diagnostics test as described in the following steps, or purchase a calibration program DVD tool to help you fine-tune the display settings.



If you are using a Polycom HDX media cart or Polycom HDX Executive Collection, select the Polycom menu option on the monitor to optimize the display for Polycom video.

### To adjust the monitor for natural color:

- 1 Do one of the following:
  - In the local interface, go to **System > Diagnostics > Video**.
  - In the web interface, go to **Diagnostics > Video**.
- 2 Select the color bars icon to display the color bar test screen.
- 3 Adjust the color using the monitor's controls for color, contrast, and brightness. Your monitor may also have controls for tint and temperature.

The colors from left to right should be white, yellow, cyan, green, magenta, red, and blue. Make sure that the white is not tinted red, green, or blue, and that the red is not tinted pink or orange.



Polycom HDX 4000 series displays are calibrated at the factory and do not require color adjustment. You can make the Polycom HDX 4000 series display brighter or dimmer using the + and - controls on the side of the monitor.

- 4 When the colors look right on the test screen, press **Near** until you see video of the room.
- 5 If the color appears natural, you do not need to make further adjustments.

If the color still needs adjustment, use the monitor's controls to make small adjustments until the picture appears natural.

## Preventing Monitor Burn-In

Monitors and Polycom HDX systems provide display settings to help prevent image burn-in. Plasma televisions can be particularly vulnerable to this problem. Refer to your monitor's documentation or manufacturer for specific recommendations and instructions. The following guidelines help prevent image burn-in:

- For monitors that support low-power mode when no signal is present on the monitor input, set **Output upon Screen Saver Activation** to **No Signal**. For example, use the **No Signal** setting on VGA monitors and monitors provided by Polycom with native 1080 resolution. Otherwise, set **Output upon Screen Saver Activation** to **Black**.
- Use the monitor's burn-in prevention features, if available.

- Ensure that static images are not displayed for long periods.
- Set the **Screen Saver Wait Time** to 3 minutes or less.
- To keep the screen clear of static images during a call, disable the following settings:
  - **Display Icons in a Call** described on page 3-9
  - **Display Time in Call** described on page 6-1
  - **Far Site Name Display Time** described on page 6-2
- Be aware that meetings that last more than an hour without much movement can have the same effect as a static image.
- Consider decreasing the monitor's sharpness, brightness, and contrast settings if they are set to their maximum values.

## Connecting Cameras

Polycom HDX 9000 series, Polycom HDX 8000 series, and Polycom HDX 7000 series systems provide inputs for multiple PTZ cameras. You can use the RS-232 serial port on the system to control supported non-Polycom cameras or cameras not connected to a main camera input.

Polycom HDX 8000 series, Polycom HDX 7000 series, and Polycom HDX 6000 series systems *must* be connected to a camera with an IR receiver to receive signals from the remote control. Be sure to point the remote control at the camera to control those Polycom HDX systems. Refer to the "Interoperability" section of the current HDX system release notes for a list of supported cameras with IR receivers.



If you use a Sony RS-232 cable for PTZ control of a Sony camera, the built-in IR receiver might not map to the correct pin on the Polycom HDCI Breakout adapter. If you experience this problem, use the Polycom HDX HDCI-Sony cable to get the correct mapping.

## Polycom EagleEye HD



You can use the Polycom EagleEye HD camera with all 1080p-enabled Polycom HDX systems to send and receive 1080p encoded video. You can also use the Polycom EagleEye HD camera with HDX systems that do not have the 1080p option, but you will not receive 1080p encoded video.



When connecting a Polycom EagleEye HD camera to video input 2 on a Polycom HDX 9000 series or Polycom HDX 8000 series system, use only the approved Polycom UL Listed adaptor, Class 2 or LPS not exceeding 12 Volts, 3.33 Amps (part number 1465-52733-040). Verify the polarity of the power supply as shown on the Polycom camera next to the power supply input.

## Polycom EagleEye 1080



You can use the Polycom EagleEye 1080 camera for Polycom HDX systems with the 1080p Resolution option installed if you want to send and receive 1080p video. You can also use the Polycom EagleEye 1080 with systems that do not have the 1080p Resolution option, to see local video in 1080 format.



When connecting a Polycom EagleEye 1080 camera to any input on a Polycom HDX system, use the cable and power supply that come with the camera. You must always use the power supply because the Polycom HDX EagleEye 1080 camera does not receive power from the Polycom HDX system.

## Polycom EagleEye View



The Polycom EagleEye View camera is a manual-focus, electronic pan, tilt, and zoom (EPTZ) camera that includes built-in stereo microphones and a privacy shutter. The Polycom EagleEye View is available with the Polycom HDX 6000 HD system as the system camera and the main microphone. You can also use it with the Polycom HDX 9000 series, Polycom HDX 8000 series, and Polycom HDX 7000 series systems. For more information about the Polycom EagleEye View microphones, refer to [Using the Polycom EagleEye View Microphones](#) on page 4-3.



When connecting a Polycom EagleEye View camera, use the brown cable that comes with the camera if you want to use the camera's built-in microphones. Other cables may not carry the audio signals.

You can install the Polycom EagleEye View in a base-down orientation or inverted. To change the camera's orientation after installation, disconnect all cables attached to the camera. Then install the camera with the preferred orientation and reconnect the camera.

The Polycom EagleEye View camera can provide 1080i video to the Polycom HDX 9006, Polycom HDX 8000 series, Polycom HDX 7000 series, and Polycom HDX 6000 series systems.

To use the Polycom EagleEye View camera, systems must be running HDX software version 2.6 or later.

## Polycom EagleEye II



The Polycom EagleEye II camera provides 1080i 50/60 fps component video only, and other video mode outputs are as modified by the attached HDX system.



The Polycom EagleEye II camera is not supported on Polycom HDX 9004, Polycom HDX 9002, or Polycom HDX 9001 systems.

To use the Polycom EagleEye II camera, systems must be running software version 2.6.1 or later.

## Polycom EagleEye III



The Polycom EagleEye III camera can provide 1080i 60/50 fps, 1080p 30 fps, and 720p 60/50 fps resolutions on all Polycom HDX **room** systems.

To use the Polycom EagleEye III camera, systems must be running HDX software version 3.0.1 or later.

## Polycom EagleEye Director



The EagleEye Director is a high-end device that works in conjunction with a Polycom HDX system to provide accurate close-up views of the person who is speaking. The EagleEye Director also provides smooth transitions between the close-up view of the person who is speaking and the room view.

The EagleEye Director uses a dual-camera system. While one camera tracks the person who is speaking, the other camera captures the room view. The EagleEye Director shows the room view while the camera moves from one speaker to another. When the tracking camera locates a person who is speaking, the EagleEye Director camera switches to a close-up of that person. By providing automatic and intelligent views in various speaking scenarios during a conference, the EagleEye Director delivers a user experience similar to a newscast video production.

EagleEye Director is supported on the following Polycom systems:

- HDX 9000 series
- HDX 8000 series
- HDX 7000 series
- HDX 6000 series

To use the Polycom EagleEye Director, HDX systems must be running HDX software version 3.0.1 or later. The Polycom EagleEye Director must be using two Polycom EagleEye II or Polycom EagleEye III cameras, within the parameters previously described for each camera.

## Connecting Cameras to Polycom HDX Systems

Refer to your system's setup sheet and to the *Integrator's Reference Manual for Polycom HDX Systems* for connection details. Refer to the release notes for a list of supported PTZ cameras. If you connect a supported PTZ camera, the system detects the camera type and sets the appropriate configuration. Make sure that the system is powered off before you connect devices to it.



Do not connect more than one Polycom EagleEye Director to a single HDX system.

### Polycom HDX 9000 Series Systems

#### Polycom HDX 9006 System

The following table shows how you can connect video sources to a Polycom HDX 9006 system.

Video Input Number	Connector	Acceptable Input	Resolution/ Frame Rate (fps)	Audio Association	Power	Control
1	HDCI	Composite, S-Video	<b>People Only:</b> 480i/60, 576i/50	None	Provided for Polycom EagleEye cameras	PTZ Camera, IR Input
		Component	<b>People Only:</b> 720p/60, 720p/50, 480p/60, 480p/30, 576p/50, 576p/25, 480i/60, 576i/50, 1080p/30, 1080i/60, 1080p/25, 1080i/50	None	Provided for Polycom EagleEye cameras	PTZ Camera, IR Input
	BNC+Serial	Component	<b>People Only:</b> 720p/60, 720p/50, 480p/60, 480p/30, 576p/50, 576p/25, 480i/60, 576i/50, 1080p/30, 1080i/60, 1080p/25, 1080i/50	None	None	PTZ Camera, IR Input

Video Input Number	Connector	Acceptable Input	Resolution/ Frame Rate (fps)	Audio Association	Power	Control
2	HDCI	Component	<b>People or Content:</b> 720p/60, 720p/50, 480p/60, 480p/30, 576p/50, 576p/25, 480i/60, 576i/50 <b>People Only:</b> 1080p/30, 1080i/60, 1080p/25, 1080i/50	None	None	PTZ Camera
		Composite, S-Video	<b>People or Content:</b> 480i/60, 576i/50	None	None	PTZ Camera
3 (VCR/DVD Player)	BNC	Component	<b>People or Content:</b> 720p/60, 720p/50, 480p/60, 480p/30, 576p/50, 576p/25, 480i/60, 576i/50 <b>People Only:</b> 1080p/30, 1080i/60, 1080p/25, 1080i/50	Audio Input 3	None	None (Use Serial Port)
4	DVI-I	DVI-A, DVI-D	<b>People or Content:</b> 640 x 480/60, 800 x 600/60, 1024 x 768/60, 1280 x 720/60, 1280 x 960/60, 1280 x 1024/60, 1680 x 1050/60, 1920 x 1080/60	Audio Input 4	None	None (Use Serial Port)



### Polycom HDX 9004, HDX 9002, HDX 9001 Systems

The following table shows how you can connect video sources to a Polycom HDX 9004, Polycom HDX 9002, or Polycom HDX 9001 system.

Video Input Number	Connector	Acceptable Input	Resolution/ Frame Rate (fps)	Audio Association	Power	Control
1	HDCI	Composite, S-Video	<b>People Only:</b> 480i/60, 576i/50	None	Provided for Polycom EagleEye HD	PTZ Camera, IR Input
		Component	<b>People Only:</b> 720p/60, 720p/50, 480p/60, 480p/30, 576p/50, 576p/25, 480i/60, 576i/50 1080p/30, 1080i/60, 1080p/25, 1080i/50	None	Provided for Polycom EagleEye HD cameras	PTZ Camera, IR Input
		DVI-D	<b>People Only:</b> 720p/30, 1080p/15	None	Provided for Polycom EagleEye HD	PTZ Camera, IR Input
2	HDCI	Composite, S-Video	<b>People or Content:</b> 480i/60, 576i/50	None	None	PTZ Camera
		Component	<b>People or Content:</b> 720p/60, 720p/50, 480p/60, 480p/30, 576p/50, 576p/25, 480i/60, 576i/50 <b>People Only:</b> 1080p/30, 1080i/60, 1080p/25, 1080i/50	None	None	PTZ Camera

Video Input Number	Connector	Acceptable Input	Resolution/ Frame Rate (fps)	Audio Association	Power	Control
<b>3 (VCR/DVD Player)</b> BNC		Component (Component is Polycom HDX 9004 only)	<b>People or Content:</b> 720p/60, 720p/50, 480p/60, 480p/30, 576p/50, 576p/25, 480i/60, 576i/50 <b>People Only:</b> 1080p/30, 1080i/60, 1080p/25, 1080i/50	Audio Input 3	None	None (Use Serial Port)
		Composite, S-Video	<b>People or Content:</b> 480i/60, 576i/50	Audio Input 3	None	None (Use Serial Port)
<b>4</b>	DVI-I	DVI-A, DVI-D	<b>People or Content:</b> 640 x 480/60, 800 x 600/60, 1024 x 768/60, 1280 x 720/60, 1280 x 1024/60	Audio Input 4 (Polycom HDX 9004)	None	None (Use Serial Port)
<b>5</b> Polycom HDX 9004	DVI-I	DVI-A, DVI-D	<b>People or Content:</b> 640 x 480/60, 800 x 600/60, 1024 x 768/60, 1280 x 720/60, 1280 x 1024/60	None	None	None (Use Serial Port)

### Polycom HDX 8000 Series Systems

The following table shows how you can connect video sources to a Polycom HDX 8000 series system.

Video Input Number	Connector	Acceptable Input	Resolution/ Frame Rate (fps)	Audio Association	Power	Control
<b>1</b>	HDCI	Composite, S-Video	<b>People Only:</b> 480i/60, 576i/50	None	Provided for EagleEye cameras	PTZ Camera, IR Input
		Component	<b>People Only:</b> 720p/60, 720p/50, 480p/60, 480p/30, 576p/50, 576p/25, 480i/60, 576i/50 1080p/30, 1080i/60, 1080p/25, 1080i/50	None	Provided for EagleEye cameras	PTZ Camera, IR Input

Video Input Number	Connector	Acceptable Input	Resolution/ Frame Rate (fps)	Audio Association	Power	Control
2	HDCI	Composite, S-Video	<b>People or Content:</b> 480i/60, 576i/50	None	None	PTZ Camera
		Component	<b>People or Content:</b> 720p/60, 720p/50, 480p/60, 480p/30, 576p/50, 576p/25, 480i/60, 576i/50 <b>People Only:</b> 1080p/30, 1080i/60, 1080p/25, 1080i/50	None	None	PTZ Camera
3 (VCR/DVD Player)	S-Video	Composite, S-Video	<b>People or Content:</b> 480i/60, 576i/50	Audio Input 3	None	None (Use Serial Port)
4	DVI-I	DVI-A, DVI-D	<b>People or Content:</b> 640 x 480/60, 800 x 600/60, 1024 x 768/60, 1280 x 720/60, 1280 x 960/60, 1280 x 1024/60, 1680 x 1050/60, 1920 x 1080/60	Audio Input 4	None	None (Use Serial Port)

### Polycom HDX 7000 Series Systems

The following table shows how you can connect video sources to a Polycom HDX 7000 Hardware Version A, B, C, or D system.

Video Input Number	Connector	Acceptable Input	Resolution/ Frame Rate (fps)	Audio Association	Power	Control
1	HDCI	Composite, S-Video	<b>People Only:</b> 480i/60, 576i/50	None	Provided for EagleEye cameras	PTZ Camera, IR Input
		Component	<b>People Only:</b> 720p/60, 720p/50, 480p/60, 480p/30, 576p/50, 576p/25, 480i/60, 576i/50, 1080p/30, 1080i/60, 1080p/25, 1080i/50	None	Provided for EagleEye cameras	PTZ Camera, IR Input

Video Input Number	Connector	Acceptable Input	Resolution/ Frame Rate (fps)	Audio Association	Power	Control
<b>2</b> <b>(VCR/DVD Player)</b>	S-Video	Composite, S-Video	<b>People or Content:</b> 480i/60, 576i/50	Audio Input 2	None	None (Use Serial Port)
<b>3</b>	DVI-I	DVI-A, DVI-D	<b>People or Content:</b> 640 x 480/60, 800 x 600/60, 1024 x 768/60, 1280 x 720/60, 1280 x 960/60, 1280 x 1024/60, 1680 x 1050/60, 1920 x 1080/60	Audio Input 3	None	None (Use Serial Port)

### Polycom HDX 6000 Series Systems

The following table shows how you can connect video sources to a Polycom HDX 6000 series system.

Video Input Number	Connector	Acceptable Input	Resolution/ Frame Rate (fps)	Audio Association	Power	Control
<b>1</b>	HDCI	Composite, S-Video	<b>People Only:</b> 480i/60, 576i/50	None	Provided for EagleEye cameras	PTZ Camera, IR Input
		Component	<b>People Only:</b> 720p/60, 720p/50, 480p/60, 480p/30, 576p/50, 576p/25, 480i/60, 576i/50  1080p/30, 1080i/60, 1080p/25, 1080i/50	None	Provided for EagleEye cameras	PTZ Camera, IR Input
<b>2</b>	DVI-I	DVI-A, DVI-D	<b>People or Content:</b> 640 x 480/60, 800 x 600/60, 1024 x 768/60, 1280 x 720/60, 1280 x 960/60, 1280 x 1024/60, 1680 x 1050/60	3.5 mm Input	None	None

## Polycom HDX 4000 Series Systems

The following table shows how you can connect video sources to a Polycom HDX 4000 series system.

Video Input Number	Connector	Acceptable Input	Resolution/ Frame Rate (fps)	Audio Association	Power	Control
1	HDCI	Component (Polycom HDX 4000 series built-in camera)	<b>People Only:</b> 720p/60, 720p/50	None	Built in	PTZ Camera, IR/Keypad Input
2	DVI-I	DVI-A, DVI-D	<b>People or Content:</b> 640 x 480/60, 800 x 600/60, 1024 x 768/60, 1280 x 720/60, 1280 x 960/60, 1280 x 1024/60, 1680 x 1050/60, 1920 x 1080/60	3.5 mm Input	None	None

## Polycom HDX 4500 Systems

The following table shows how you can connect video sources to a Polycom HDX 4500 system.

Video Input Number	Connector	Acceptable Input	Resolution/ Frame Rate (fps)	Audio Association	Power	Control
1	HDCI	Component (Polycom HDX 4000 series built-in camera)	<b>People Only:</b> 1080p/30, 1080i/60, 1080p/25, 1080i/50	None	Built in	PTZ Camera, IR/Keypad Input
2	DVI-I	DVI-A, DVI-D	<b>People or Content:</b> 640 x 480/60, 800 x 600/60, 1024 x 768/60, 1280 x 720/60, 1280 x 960/60, 1280 x 1024/60, 1680 x 1050/60, 1920 x 1080/60	3.5 mm Input	None	None

## Configuring Camera Settings and Video Quality Options

### To configure camera and video settings:

- 1 Do one of the following:
  - In the local interface, go to **System > Admin Settings > Cameras > Camera Settings**.
  - In the web interface, go to **Admin Settings > Cameras > Camera Settings**.
- 2 Configure these settings on the Cameras screen:



Setting	Description
<b>Camera 1</b>	<p>Specifies the camera's aspect ratio:</p> <ul style="list-style-type: none"> <li>• <b>4:3</b> — Select if you are using a camera in standard mode.</li> <li>• <b>16:9</b> — Select if you are using a camera in wide-screen mode.</li> </ul> <p>This setting also configures the following SD cameras to produce the corresponding video format:</p> <ul style="list-style-type: none"> <li>• Polycom PowerCam™ Plus</li> <li>• Polycom PowerCam</li> <li>• Sony EVI-D100</li> <li>• Sony BRC-300</li> </ul> <p>Specifies the camera's format. For a list of available formats, refer to the information for your system in the previous section of this chapter, <a href="#">Connecting Cameras</a> on page 3-14.</p>
<b>Name</b>	Specifies a name and icon for the camera.
<b>Video Quality</b>	<p>Specifies <b>Motion</b> or <b>Sharpness</b> for the video input. The default is Sharpness.</p> <ul style="list-style-type: none"> <li>• <b>Motion</b> — This setting is for showing people or other video with motion.</li> <li>• <b>Sharpness</b> — The picture will be sharp and clear, but moderate to heavy motion at low call rates can cause some frames to be dropped. Sharpness is available in point-to-point H.263 and H.264 calls only. It is required for HD calls between 832 kbps and 2 Mbps.</li> </ul>

Setting	Description
<b>Detect Camera</b> Polycom HDX 9006 Polycom HDX 9004 Polycom HDX 9002 Polycom HDX 9001 Polycom HDX 8000 HD Polycom HDX 7000 HD Polycom HDX 7000 Polycom HDX 6000 HD	Detects any supported PTZ camera connected to Polycom HDX system video input 1 and configures the camera settings accordingly.  <b>Note:</b> If a camera fails to wake up when the HDX system wakes up, try detecting the camera again.
<b>Camera 2</b> Polycom HDX 9006 Polycom HDX 9004 Polycom HDX 9002 Polycom HDX 9001 Polycom HDX 8000 HD	Specifies the camera's aspect ratio: <ul style="list-style-type: none"> <li>• <b>4:3</b> — Select if you are using a regular camera.</li> <li>• <b>16:9</b> — Select if you are using a wide-screen camera.</li> </ul> This setting also configures the following SD cameras to produce the corresponding video format: <ul style="list-style-type: none"> <li>• Polycom PowerCam Plus</li> <li>• Polycom PowerCam</li> <li>• Sony EVI-D100</li> <li>• Sony BRC-300</li> </ul> Specifies the camera's format. For a list of available formats, refer to the information for your system in the previous section of this chapter, <a href="#">Connecting Cameras</a> on page 3-14.
<b>Name</b> Polycom HDX 9006 Polycom HDX 9004 Polycom HDX 9002 Polycom HDX 9001 Polycom HDX 8000 HD	Specifies a name and icon for the camera.
<b>Source</b> Polycom HDX 9006 Polycom HDX 9004 Polycom HDX 9002 Polycom HDX 9001	Specifies whether the camera source is <b>People</b> or <b>Content</b> . Video sources specified as <b>Content</b> are sent at a higher resolution and lower frame rate.  Content sent to Polycom HDX 8000 systems displays at a maximum of 720p.
<b>Video Quality</b> Polycom HDX 9006 Polycom HDX 9004 Polycom HDX 9002 Polycom HDX 9001 Polycom HDX 8000 HD	Specifies <b>Motion</b> or <b>Sharpness</b> for the video input. <ul style="list-style-type: none"> <li>• <b>Motion</b> — This setting is for showing people or other video with motion.</li> <li>• <b>Sharpness</b> — The picture will be sharp and clear, but moderate to heavy motion at low call rates can cause some frames to be dropped. Sharpness is available in point-to-point H.263 and H.264 calls only.</li> </ul>

Setting	Description
<p><b>Detect Camera</b>                      Polycom HDX 9006                      Polycom HDX 9004                      Polycom HDX 9002                      Polycom HDX 9001                      Polycom HDX 8000 HD</p>	<p>Detects any supported PTZ camera connected to Polycom HDX system video input 2 and configures the camera settings accordingly.</p>
<p><b>Camera 3</b> (Camera 2 on Polycom HDX 7000 series)                      Polycom HDX 9006                      Polycom HDX 9004                      Polycom HDX 9002                      Polycom HDX 9001                      Polycom HDX 8000 HD                      Polycom HDX 7000 HD                      Polycom HDX 7000</p>	<p>Specifies the VCR or DVD player's aspect ratio:</p> <ul style="list-style-type: none"> <li>• <b>4:3</b> — Select if you are using a VCR or DVD player in standard mode.</li> <li>• <b>16:9</b> — Select if you are using a VCR or DVD player in wide-screen mode.</li> </ul> <p>Specifies the VCR or DVD player's format. For a list of available formats, refer to the information for your system in the previous section of this chapter, <a href="#">Connecting Cameras</a> on page 3-14.</p>
<p><b>Name</b>                      Polycom HDX 9006                      Polycom HDX 9004                      Polycom HDX 9002                      Polycom HDX 9001                      Polycom HDX 8000 HD                      Polycom HDX 7000 HD                      Polycom HDX 7000</p>	<p>Specifies a name and icon for the VCR or DVD player.</p>
<p><b>Source</b>                      Polycom HDX 9006                      Polycom HDX 9004                      Polycom HDX 9002                      Polycom HDX 9001                      Polycom HDX 8000 HD                      Polycom HDX 7000 HD                      Polycom HDX 7000</p>	<p>Specifies whether the video source is <b>People</b> or <b>Content</b>. Video sources specified as <b>Content</b> are sent at a higher resolution and lower frame rate.</p> <p><b>Note:</b> If you change this setting on a Polycom HDX 7000 series system, the Source for Camera 3 is automatically changed to match this setting.</p>
<p><b>Video Quality</b>                      Polycom HDX 9006                      Polycom HDX 9004                      Polycom HDX 9002                      Polycom HDX 9001                      Polycom HDX 8000 HD                      Polycom HDX 7000 HD                      Polycom HDX 7000</p>	<p>Specifies <b>Motion</b> or <b>Sharpness</b> for the video input.</p> <ul style="list-style-type: none"> <li>• <b>Motion</b> — This setting is for showing people or other video with motion.</li> <li>• <b>Sharpness</b> — The picture will be sharp and clear, but moderate to heavy motion at low call rates can cause some frames to be dropped. Sharpness is available in point-to-point H.263 and H.264 calls only.</li> </ul>
<p><b>Detect Camera</b>                      Polycom HDX 9006                      Polycom HDX 9004                      Polycom HDX 9002                      Polycom HDX 9001                      Polycom HDX 8000 HD                      Polycom HDX 7000 HD                      Polycom HDX 7000</p>	<p>Detects any supported PTZ camera connected to Polycom HDX system video input 3 (input 2 on Polycom HDX 7000 series), and configures the camera settings accordingly. This button appears only when <b>RS-232 Mode</b> is set to <b>Camera PTZ</b> and <b>Camera Control</b> is set to <b>Camera 3</b> (Camera 2 on Polycom HDX 7000 series) for one of the serial ports.</p>



Setting	Description
<b>Camera 4</b> (Camera 3 on Polycom HDX 7000 series, Camera 2 on Polycom HDX 6000 series) Polycom HDX 9006 Polycom HDX 9004 Polycom HDX 9002 Polycom HDX 9001 Polycom HDX 8000 HD Polycom HDX 7000 HD Polycom HDX 7000 Polycom HDX 6000 HD	Resolution and aspect ratio are detected automatically.
<b>Name</b> Polycom HDX 9006 Polycom HDX 9004 Polycom HDX 9002 Polycom HDX 9001 Polycom HDX 8000 HD Polycom HDX 7000 HD Polycom HDX 7000 Polycom HDX 6000 HD	Specifies a name and icon for the computer or video source.
<b>Source</b> Polycom HDX 9006 Polycom HDX 9004 Polycom HDX 9002 Polycom HDX 9001 Polycom HDX 8000 HD Polycom HDX 7000 HD Polycom HDX 7000 Polycom HDX 6000 HD	Specifies whether the video source is <b>People</b> or <b>Content</b> . Video sources specified as <b>Content</b> are sent at a higher resolution and lower frame rate.  If you use this setting for PC input, the maximum resolution setting is 1280x1050, but the HDX 8000 series can display content at a maximum resolution of 1280x1024.  <b>Note:</b> If you change this setting on a Polycom HDX 7000 series system, the Source for Camera 2 is automatically changed to match this setting.
<b>Video Quality</b> Polycom HDX 9006 Polycom HDX 9004 Polycom HDX 9002 Polycom HDX 9001 Polycom HDX 8000 HD Polycom HDX 7000 HD Polycom HDX 7000 Polycom HDX 6000 HD	Specifies <b>Motion</b> or <b>Sharpness</b> for the video input. <ul style="list-style-type: none"> <li>• <b>Motion</b> — This setting is for showing people or other video with motion.</li> <li>• <b>Sharpness</b> — The picture will be sharp and clear, but moderate to heavy motion at low call rates can cause some frames to be dropped. Sharpness is available in point-to-point H.263 and H.264 calls only.</li> </ul>
<b>Detect Camera</b> Polycom HDX 9006 Polycom HDX 9004 Polycom HDX 9002 Polycom HDX 9001 Polycom HDX 8000 HD Polycom HDX 7000 HD Polycom HDX 7000	Detects any supported PTZ camera connected to Polycom HDX system video input 4 (input 3 on Polycom HDX 7000 series), and configures the camera settings accordingly. This button appears only when <b>RS-232 Mode</b> is set to <b>Camera PTZ</b> and <b>Camera Control</b> is set to <b>Camera 4</b> (Camera 3 on Polycom HDX 7000 series) for one of the serial ports.

Setting	Description
<b>Horizontal Position, Phase, Vertical Position</b> Polycom HDX 9004 Polycom HDX 9002 Polycom HDX 9001 Polycom HDX 6000 HD	Adjusts the VGA Input settings. <ol style="list-style-type: none"> <li>1 Select <b>Horizontal Position, Phase, or Vertical Position</b>.</li> <li>2 Adjust the settings using the remote control or the web interface.</li> <li>3 Press  <b>Back</b> on the remote control to accept the setting or select <b>Update</b> in the web interface.</li> </ol>
<b>Camera 5</b> Polycom HDX 9004	Resolution and aspect ratio are detected automatically.
<b>Name</b> Polycom HDX 9004	Specifies a name and icon for the computer or video source.
<b>Source</b> Polycom HDX 9004	Specifies whether the video source is <b>People</b> or <b>Content</b> . Video sources specified as <b>Content</b> are sent at a higher resolution and lower frame rate.
<b>Video Quality</b> Polycom HDX 9004	Specifies <b>Motion</b> or <b>Sharpness</b> for the video input. <ul style="list-style-type: none"> <li>• <b>Motion</b> — This setting is for showing people or other video with motion.</li> <li>• <b>Sharpness</b> — The picture will be sharp and clear, but motion will not be smooth. Choose this setting for document cameras. Sharpness is available in point-to-point H.263 calls only.</li> </ul>
<b>Detect Camera</b> Polycom HDX 9004	Detects any supported PTZ camera connected to Polycom HDX system video input 5, and configures the camera settings accordingly. This button appears only when <b>RS-232 Mode</b> is set to <b>Camera PTZ</b> and <b>Camera Control</b> is set to <b>Camera 5</b> for one of the serial ports.
<b>Horizontal Position, Phase, Vertical Position</b> Polycom HDX 9004	Adjusts the VGA Input settings. <ol style="list-style-type: none"> <li>1 Select <b>Horizontal Position, Phase, or Vertical Position</b>.</li> <li>2 Adjust the settings using the remote control or the web interface.</li> <li>3 Press  <b>Back</b> on the remote control to accept the setting or select <b>Update</b> in the web interface.</li> </ol>
<b>Far Control of Near Camera</b>	Specifies whether the far site can pan, tilt, or zoom the near-site camera. When this option is selected, a user at the far site can control the framing and angle of the camera for the best view of the near site.

Setting	Description
<b>Backlight Compensation</b>	<p>Specifies whether to have the camera automatically adjust for a bright background. Backlight compensation is best used in situations where the subject appears darker than the background.</p> <p>Enabling this setting helps to relieve a bright background, which can impact the tracking performance of the Polycom EagleEye Director.</p>
<b>Primary Camera</b>	<p>Specifies which camera is the main camera. The primary camera is active when the Polycom HDX system powers up. Its source is automatically set to People.</p> <p>Changing this setting causes the system to restart. After the system restarts, you might need to select <b>Detect Camera</b>.</p>
<b>Camera Pan Direction</b>	<p>Specifies the direction the camera moves when using the arrow buttons on the remote control.</p>
<b>Quality Preference</b>	<p>Specifies the bandwidth split for People and Content video.</p> <ul style="list-style-type: none"> <li>• <b>People</b> – 10% Content, 90% People</li> <li>• <b>Both</b> – 50% Content, 50% People</li> <li>• <b>Content</b> – 90% Content, 10% People</li> </ul> <p><b>Notes:</b> In a multipoint call, the MCU setting determines the People and Content video rates, not the system sending the content.</p> <p>This setting does not apply if <b>Dynamic People/Content Bandwidth</b> is enabled or automatic bandwidth adjustment is enabled using the API.</p> <p>This setting applies only to calls of 128 kbps or higher.</p>
<b>Dynamic People/Content Bandwidth</b>	<p>Specifies whether the system automatically adjusts the bandwidth allocation for people and content in point-to-point H.323 and SIP calls. This setting maintains equal image quality for People and Content in the call.</p>
<b>Power Frequency</b>	<p>Specifies the power line frequency for your system.</p> <p>In most cases, the system defaults to the correct power line frequency, based on the video standard used in the country where the system is located. This setting allows you to adapt the system in areas where the power line frequency does not match the video standard used. You may need to change this setting to avoid flicker from the fluorescent lights in your conference room.</p>

Setting	Description
<b>Send Content When PC Connects</b> Polycom HDX 9006 Polycom HDX 9004 Polycom HDX 9002 Polycom HDX 9001 Polycom HDX 8000 HD Polycom HDX 6000 HD	Specifies whether to send content automatically when a computer is connected to a designated content input.
<b>Detect Cameras</b> Polycom HDX 9006 Polycom HDX 9004 Polycom HDX 9002 Polycom HDX 9001 Polycom HDX 8000 HD Polycom HDX 7000 HD Polycom HDX 7000	Detects any supported PTZ cameras connected to Polycom HDX system video inputs.

## Configuring the Polycom EagleEye Director

Use the remote control or web interface to configure the Polycom EagleEye Director. You cannot configure the EagleEye Director using the Polycom Touch Control.

### Getting Started

Refer to *Setting up the Polycom HDX EagleEye Director Camera* for information about how to set up the EagleEye Director.

After setting up the EagleEye Director, follow these steps to get started:

- 1 Power on EagleEye Director and detect the cameras (refer to the Detect Camera setting on page 3-25).

You can verify that the cameras are detected and compatible with the HDX system's software on the System Status page. Do one of the following:

- In the local interface, go to **System > Diagnostics > System Status**.
- In the web interface, go to **Diagnostics > System Status**.

If the camera has been detected, **Camera Software Compatibility** appears as the last line on the page. If the camera software is compatible with the HDX system software, the arrow to the right of the line is green. If the arrow is red, you should update the software as described in *Installing Software and Options for Polycom HDX Systems and Accessories*.

- 2 Calibrate the cameras. Refer to [Calibrating the Cameras](#) on page 3-31 for instructions. If you notice that the speaker is not framed accurately, ensure that the vertical bar of the EagleEye Director is vertical. Placing the EagleEye Director on a horizontal surface can help to ensure that the vertical bar is vertical. You might also need to recalibrate the cameras.

- 3 Adjust the room view. Refer to [Adjusting the Room View](#) for instructions.



#### Points to note when detecting the Polycom EagleEye Director

If the EagleEye Director is not detected, try one of the following solutions:

- Ensure all cables are tightly plugged in and the ball stubs are tightly pressed into the hole on the base, then attempt camera detection again.
- If the EagleEye Director is powering on or waking up from sleep, wait for a few seconds and then attempt to detect the camera again.
- Manually power off the EagleEye Director by unplugging the power supply of the EagleEye Director and unplugging the HDCI cable from the HDX system. Then power on the EagleEye Director, plug the HDCI cable into the HDX system, and attempt camera detection again.

## Calibrating the Cameras

- 1 Do one of the following:
  - From the local interface, go to **System > Admin Settings > Cameras > Camera Calibration**.
  - From the web interface, go to **Admin Settings > Cameras** and select **Camera Calibration**.
- 2 Use the arrow buttons and zoom controls on the remote control or web interface to zoom completely in, then aim the camera at your mouth.
- 3 Select **Begin Calibration** and begin counting aloud while facing the camera until a message displays indicating successful calibration.



Ensure that only one person speaks while you are calibrating the cameras and keep the background quiet.

If you rearrange or move the Polycom EagleEye Director, recalibrate its cameras.

If you cannot successfully calibrate the cameras, ensure that all seven EagleEye Director tracking microphones are working correctly. Five of those microphones are horizontal and two are vertical reference audio microphones. Calibration fails if any of the microphones do not work. For ways to test microphone functionality, refer to the **Camera Audio Meter** setting on page 11-6.

## Adjusting the Room View

- 1 Do one of the following:
  - From the local interface, go to **System > Admin Settings > Cameras > Adjust Room View**.
  - From the web interface, go to **Admin Settings > Cameras** and select **Adjust Room View**.

- 2 Use the arrow buttons and zoom controls on the remote control or web interface to show the room view you want for site participants to see.
- 3 Press or click **Back** to save the settings and return to the Camera Settings screen.

## Starting and Stopping Camera Tracking with EagleEye Director

If you enable the **Voice** tracking mode, EagleEye Director camera tracking can be started and stopped by using the remote control or Polycom Touch Control.

### To start camera tracking:

- >> Do one of the following:
  - Press the **Option** button on the remote control and select **Start Camera Tracking**.
  - If the HDX system is paired with a Polycom Touch Control, follow these steps:
    - 1 Touch **Cameras** on the Home screen or the Call screen.
    - 2 If the EagleEye Director is not currently selected, select it:
      - a Touch **Select Cameras** and select the EagleEye Director.
      - b Touch **Control Camera**.
    - 3 Select **Start Camera Tracking**.

### To stop camera tracking:

- >> Do one of the following:
  - Press the **Option** button on the remote control and select **Stop Camera Tracking**.
  - If the HDX system is paired with a Polycom Touch Control, touch **Cameras** on the Home screen or the Call screen and select **Stop Camera Tracking**.

Camera tracking can also start or stop based on the following actions:

- Camera tracking starts automatically when you make a call.
- Camera tracking stops after you hang up a call.

- Camera tracking temporarily stops when you mute the HDX system. It resumes when you unmute the HDX system.



Tracking performance can be affected by room lighting. If the room is too bright for camera tracking to work properly, you can improve the tracking performance by adjusting the **Backlight Compensation** setting on the Cameras screen. To find this setting in the local interface, go to **System > Admin Settings > Cameras > Camera Settings**. In the web interface, you can go to **Admin Settings > Cameras > Camera Settings**.

## Setting the Tracking Mode

- 1 Do one of the following:
  - From the local interface, go to **System > Admin Settings > Cameras > Camera Tracking Settings**.
  - From the web interface, go to **Admin Settings > Cameras**.
- 2 Select the preferred tracking mode from the **Tracking Mode** menu:
  - **Voice:** This is the default tracking mode. In this mode, the camera automatically tracks the current speaker in the room using a voice tracking algorithm.

When you select the **Voice Tracking Mode**, you can also choose the **Tracking Speed**. This speed determines how quickly the camera moves to each person who speaks. The default speed is **Normal**.

If voice tracking does not work as expected, make sure the microphones are functioning properly. For ways to test microphone functionality, refer to the **Camera Audio Meter** setting on page 11-6.

- **Off:** In this mode, the tracking function is disabled. You must manually move the camera using the remote control or the Polycom Touch Control.

## Configuring Advanced Camera Settings

You can use the system's web interface to configure or restore the following Polycom EagleEye HD camera settings:

- Brightness
- Black Level
- Color Saturation

You can also use the system's web interface to configure or restore the White Balance setting for the Polycom EagleEye HD, Polycom EagleEye View, and Polycom EagleEye Director.

The EagleEye II and EagleEye III cameras do not use the setting for **Black Level**.

**To adjust the camera's brightness, black level, or color saturation using the Polycom HDX web interface:**

- 1 In your web browser address line, enter the HDX system's IP address.
- 2 Go to **Admin Settings > Cameras**.
- 3 If **Model** is not set to Polycom EagleEye HD for the appropriate camera or cameras, click the **Detect Camera** button.
- 4 Click **Advanced**.
- 5 Select values for brightness, black level, and color saturation.
- 6 Click **Update**.

**To restore the Polycom EagleEye HD or Polycom EagleEye View camera's default settings using the Polycom HDX web interface:**

- 1 In your web browser address line, enter the HDX system's IP address.
- 2 Go to **Admin Settings > Cameras**.
- 3 Click **Restore**. White Balance, Brightness, Black Level, and Color Saturation are returned to their default values.

**To set the Polycom EagleEye HD or Polycom EagleEye View white balance:**

You can set the white balance to one of several fixed values, or you can set it manually.



White balance settings require particular camera and system firmware versions. For more information, contact your Polycom distributor or refer to the Knowledge Base in the Support section of the Polycom web site.

- 1 In your web browser address line, enter the HDX system's IP address.
- 2 Go to **Admin Settings > Cameras**.
- 3 If **Model** is not set to Polycom EagleEye HD or Polycom EagleEye View for the appropriate camera or cameras, click the **Detect Camera** button.
- 4 Select a value for White Balance.
  - **Auto:** Polycom recommends this setting for most situations. It calculates the best white balance setting based on lighting conditions in the room.
  - **Pre-defined values:** Use one of the pre-defined color temperature settings to provide acceptable color reproduction.



- **Manual:** Use the Manual setting for rooms where the Auto and fixed settings do not provide acceptable color reproduction. You might find this setting helpful when you use People on Content™.

Set the White Balance to **Manual**. Then fill the camera view with a flat white surface, such as a piece of paper, and click **Calibrate**.

**5** Click **Update**.

## Configuring Camera Presets

Camera presets are stored camera positions that you can create before or during a call.

Presets allow users to:

- Automatically point a camera at pre-defined locations in a room.
- Select a video source.

If your camera supports pan, tilt, and zoom movement, and it is set to People, you can create up to 100 preset camera positions for it using the remote control or keypad. You can create up to 10 preset camera positions using the Polycom Touch Control. Each preset stores the camera number, its zoom level, and the direction it points (if appropriate). Presets remain in effect until you delete or change them.

If a Polycom Touch Control is paired with a Polycom HDX system, you must use the Polycom Touch Control to create presets. Refer to [Setting and Using Presets with the Polycom Touch Control](#) on page 3-36.



If you use a Polycom EagleEye Director with your HDX system, you cannot use presets for voice tracking.



## Setting and Using Presets with the Remote Control or Keypad

### To store a preset using the remote control:

- 1** If you are in a call, press **Near** or **Far** then choose a near-site or far-site camera or other video source.
- 2** If you selected a camera that supports electronic pan, tilt, and zoom, you can adjust the camera's position:
  - Press **Zoom** to zoom the camera out or in.
  - Press the arrow buttons on the remote control to move the camera up, down, left, or right.

- 3 Press and hold a number to store the preset position.  
To store a double-digit preset (10-99), hold the second number down.  
Any existing preset stored at the number you enter is replaced.

**To delete all presets on a Polycom HDX 9000 series, Polycom HDX 8000 series, Polycom HDX 7000 series, or a Polycom HDX 6000 series system:**

- 1 If a call is connected, press **Near** to choose a near-site video source.
- 2 Press  **Preset** on the remote control.
- 3 Press and hold  **Delete** to delete all presets.

**To delete all presets on a Polycom HDX 4000 series:**

- 1 Press **Near** on the keypad.
- 2 Press and hold  **Delete** to delete all presets.

## Setting and Using Presets with the Polycom Touch Control

**To move the camera to a stored preset:**

- 1 From the Home screen or Call screen, touch **Cameras**.
- 2 If you are in a call, touch **Near** or **Far** to select either near-site or far-site control.
- 3 Touch **View Presets**.
- 4 Touch a  number to go to a saved preset.

**To view your near-site presets:**

- 1 From the Home screen or Call screen, touch **Cameras**.
- 2 If you are in a call, touch **Near** or **Far** to select either near-site or far-site control.
- 3 Touch **View Presets**.

Icons for presets 0-9 are shown on the screen. Solid preset icons indicate stored camera positions. Transparent icons indicate unassigned presets.

**To store a preset:**

- 1 From the Home screen or Call screen, touch **Cameras**.
- 2 If you are in a call, touch **Near** or **Far** to choose a near-end or far-end camera.

- 3 Touch **Select Camera** to choose a camera or other video source.
- 4 Touch **Control Camera** to move the camera to the desired position.
- 5 Touch **View Presets**, then touch and hold a number for 5 seconds to store the preset position. Any existing preset stored at the number you select is replaced.



A far-end camera preset can be stored only if the ability to control the far-end camera is enabled.

## Experiencing High-Definition Video Conferencing

Polycom HDX 9002, Polycom HDX 9004, Polycom HDX 9006, Polycom HDX 8000 series, Polycom HDX 7000 HD, Polycom HDX 6000 HD, Polycom HDX 4000 HD, and Polycom HDX 4500 systems offer the following high-definition (HD) capabilities:

- Send people or content video to the far site in HD
- Receive and display video from the far site in HD
- Display near-site video in HD

### Sending Video in High Definition

Polycom HDX systems with HD capability can send video in wide-screen, HD format. For information about the resolution and frame rate for video configured as People, refer to [Appendix C, Call Speeds and Resolutions](#). For information about frame rates for content, refer to [Chapter 5, Content and Closed Captions](#).

To send video in HD format, use any model of Polycom camera that supports HD video and a Polycom HDX system capable of sending 720p or better video.

### Receiving and Displaying Video in High Definition

When the far site sends HD video, Polycom HDX systems with HD capability and an HD monitor can display the video in wide-screen, HD format. The HD 720 format supported by these systems is 1280 x 720, progressive scan format (720p). Polycom HDX systems with 1080 capability can receive 1080p progressive format and can display 1080p progressive or 1080i interlaced format.

Near-site video is displayed in HD format when you use an HD video source and an HD monitor. However, near-site video is displayed in SD if the system is in an SD or lower-resolution call.



**Points to note about viewing 1080 video on Polycom HDX 9006, Polycom HDX 8000 series, and Polycom HDX 7000 series systems:**

- Camera 1 and Camera 2 support 1080p (29.97/30 fps for NSTC systems, 25 fps for PAL systems) and 1080i (59.94/60 fps for NTSC, 50 fps for PAL) using Component format.
- For 1080 input from camera 2, configure the camera as a People source on the Polycom HDX system.
- Monitor 1 and Monitor 2 support 1080i (60 fps for NTSC, 50 fps for PAL) using DVI-D or Component format. They support 1080p (60 fps for NTSC, 50 fps for PAL) using DVI-D, VGA, or Component format.

**Points to note about viewing 1080 video on Polycom HDX 6000 series systems:**

- Camera 1 supports 1080p (29.97/30 fps for NSTC systems, 25 fps for PAL systems) and 1080i (59.94/60 fps for NTSC, 50 fps for PAL) using Component format.
- For 1080 input from camera 2, configure the camera as a People source on the Polycom HDX system.
- Monitor 1 supports 1080i (60 fps for NTSC, 50 fps for PAL) using DVI-D or HDMI format. It supports 1080p (60 fps for NTSC, 50 fps for PAL) using DVI-D or HDMI format.

## HD and SD Multipoint Calls

With the MPplus 4 option, the following systems can host HD multipoint calls that include up to four sites:

- Polycom HDX 9006 systems
- Polycom HDX 9004
- Polycom HDX 9002
- Polycom HDX 8000 series
- Polycom HDX 4500

With the MPplus 4 option, the following systems can host SD multipoint calls that include up to four sites:

- Polycom HDX 9001
- Polycom HDX 7000 HD systems

With the MPplus 4 option, the following systems can host up to four sites in a SIF/CIF multipoint call:

- Polycom HDX 7000
- Polycom HDX 4000

The HDX system hosting the call transmits 720p and receives 640x368 while the other endpoints transmit 640x368 and receive 720p. During this type of four-way HD or SD multipoint call, all sites can be displayed in continuous presence.



With the MPplus 8 option, Polycom HDX 9004 systems can host multipoint calls that include up to eight sites. The HDX system hosting the call transmits 720p and receives 432x240 while the other endpoints transmit 432x240 and receive 720p. Polycom HDX 9004 systems can display all eight sites in continuous presence, but only when the call is in HD. If for any reason the call is not in HD, only four sites or fewer can be displayed. For HD continuous presence, Polycom recommends setting **Multipoint Mode** to **Discussion**.



#### Requirements for an HD multipoint call:

- The call must be hosted by a Polycom HDX 9002 or Polycom HDX 9004 system running version 2.0 or later; a Polycom HDX 8000 series or Polycom HDX 4000 HD system running version 2.5 or later; a Polycom HDX 4500 system running version 3.0.1 or later, a Polycom HDX 9006 system running 2.6 or later, or a conferencing platform that supports HD such as Polycom RMX 1000 or Polycom RMX 2000.
- The Polycom HDX system host must have the appropriate options installed.
- All systems in the call must support HD (720p at 30 fps) and H.264.
- The call rate must be high enough to support HD resolution, as shown in [Appendix C, Call Speeds and Resolutions](#).
- Transcoding must be disabled.
- The call cannot be cascaded.
- The call can only include up to six sites if AES Encryption is enabled. When AES Encryption is enabled in calls with seven or eight sites, SIF/CIF video is sent.



#### Requirements for an SD multipoint call:

- The Polycom HDX system host must have the appropriate options installed.
- All sites in the call must support SD (30 fps) and H.264.
- Transcoding must be disabled.
- The call cannot be cascaded.

The following systems can participate in SD multipoint calls, but cannot host HD or SD multipoint calls:

- Polycom HDX 9001
- Polycom HDX 7000
- Polycom HDX 4000

Polycom HDX 6000 systems can participate in multipoint calls, but cannot host any type of multipoint call.

For more information about multipoint calls, refer to [Configuring Multipoint Viewing Modes](#) on page 3-11 and [Configuring Multipoint Calling](#) on page 6-3.



# Microphones and Speakers

## Connecting Audio Input

Make sure that the system is powered off before you connect devices to it.

### Connecting Audio Input to Polycom HDX 9000 Series Systems

The following table shows the acceptable input levels and video associations for the audio inputs on a Polycom HDX 9000 series system.

Audio Input Number	Connector	Acceptable Input Source Levels	Video Association
<b>1 (Main Audio)</b> Polycom HDX 9004 Polycom HDX 9002 Polycom HDX 9001	Phoenix	Mono/Stereo Microphone or Line Level (phantom power is available when set to <b>Microphone</b> )	Not associated with any particular video input. Intended as microphone input; not included in audio mix of output 1.
<b>1 (Main Audio)</b> Polycom HDX 9006 only	Phoenix	Line Level	Not associated with any particular video input. Not included in audio mix of output 1.
<b>3 (VCR/DVD Player)</b>	Phoenix	Mono/Stereo Line Level	Video Input 3 (Audio is disabled until camera 3 is selected).
<b>4 (Content)</b> Polycom HDX 9006 and Polycom HDX 9004 only	Phoenix	Mono/Stereo Line Level	Video Input 4 (Audio is disabled until camera 4 is selected).

## Connecting Audio Input to Polycom HDX 8000 Series Systems

The following table shows the acceptable input levels and video associations for the audio inputs on a Polycom HDX 8000 series system.

Audio Input Number	Connector	Acceptable Input Source Levels	Video Association
<b>1 (Main Audio)</b>	RCA	Mono/Stereo Line Level	Not associated with any particular video input. Intended as microphone input; not included in audio mix of output 1.
<b>3 (VCR/DVD Player)</b>	RCA	Mono/Stereo Line Level	Video Input 3 (Audio is disabled until camera 3 is selected).
<b>4 (Content)</b>	3.5 mm	Mono/Stereo Line Level	Video Input 4 (Audio is disabled until camera 4 is selected).

## Connecting Audio Input to Polycom HDX 7000 Series Systems

The following table shows the acceptable input levels and video associations for the audio inputs on a Polycom HDX 7000 series system.

Audio Input Number	Connector	Acceptable Input Source Levels	Video Association
<b>1 (Main Audio)</b>	RCA	Mono/Stereo Line Level	Not associated with any particular video input. Intended as microphone input; not included in audio mix of output 1.
<b>2 (VCR/DVD Player)</b>	RCA	Mono/Stereo Line Level	Video Input 2 (Audio is disabled until camera 2 is selected).
<b>3 (Content)</b>	3.5 mm	Mono/Stereo Line Level	Video Input 3 (Audio is disabled until camera 3 is selected).

## Connecting Audio Input to Polycom HDX 6000 Series Systems

The following table shows the acceptable input levels and video associations for the audio inputs on a Polycom HDX 6000 series system.

Audio Input	Connector	Acceptable Input Source Levels	Video Association
<b>Content</b>	3.5 mm	Mono/Stereo Line Level	Video Input 2 (Audio is disabled until camera 2 is selected).



## Connecting Audio Input to Polycom HDX 4000 Series Systems

The following table shows the acceptable input levels and video associations for the audio inputs on a Polycom HDX 4000 series system.

Audio Input	Connector	Acceptable Input Source Levels	Video Association
Content	3.5 mm	Mono/Stereo Line Level	Video Input 2 (Audio is disabled until content is being previewed or sent to the far site).

## Connecting Devices to the Polycom HDX Microphone Input

To pick up audio from your site, you must connect a microphone to the Polycom HDX 9000 series, Polycom HDX 8000 series, Polycom HDX 7000 series, and Polycom HDX 6000 series systems. Refer to your system's setup sheet for connection details.

### Connecting Polycom HDX Table or Ceiling Microphones

Polycom microphones each contain three microphone elements for 360° coverage. You can connect multiple Polycom microphones to a Polycom HDX system.

For best audio, do the following:

- Place the microphone on a hard, flat surface (table, wall, or ceiling) away from obstructions, so the sound will be directed into the microphone elements properly.
- Place the microphone near the people closest to the monitor.
- In large conference rooms, you may need more than one microphone. Each Polycom microphone covers a 3-6 foot radius, depending on the noise level and acoustics in the room.

### Using the Polycom EagleEye View Microphones

The Polycom EagleEye View camera includes built-in stereo microphones. For best audio when using the Polycom EagleEye View:

- Enable Polycom StereoSurround.
- Place the camera at least 1 foot away from any walls to minimize boundary effects.
- Ideally the people speaking should be no more than 7 feet away from the Polycom EagleEye View. The maximum distance covered depends on the noise level and acoustics in the room. If you connect a Polycom microphone, Polycom SoundStation, or Polycom SoundStructure® to the

HDX microphone input while a Polycom EagleEye View is connected to the system, the Polycom EagleEye View camera's built-in microphones are automatically disabled.

- Polycom recommends connecting other audio input devices in conference rooms larger than 12 feet by 15 feet.

## Connecting a Polycom SoundStation IP 7000 Phone

When you connect a Polycom SoundStation IP 7000 conference phone to a Polycom HDX system, the conference phone becomes another way to dial audio or video calls. The conference phone also operates as a microphone, and as a speaker in audio-only calls. For more information, refer to the following documents on the Polycom web site:

- *Integration Guide for the Polycom® SoundStation® IP 7000 Conference Phone Connected to a Polycom® HDX® System in Unsupported VoIP Environments*
- *User Guide for the Polycom® SoundStation® IP 7000 Phone Connected to a Polycom HDX® System in Unsupported VoIP Environments*



The SoundStation IP 7000 phone is supported with the Polycom Touch Control when both are connected to an HDX system.

## Connecting Devices to the Polycom HDX 9000 Series Microphone Input

The Polycom HDX 9000 series systems can support:

- Up to four Polycom HDX microphones (table or ceiling type).
- One SoundStation IP 7000 phone and up to two Polycom HDX microphones.
- One SoundStructure C-Series device and up to four Polycom HDX microphones.
- Polycom EagleEye View with microphones enabled.

The following diagram shows several microphone connection options for the Polycom HDX 9000 series. For information about additional cable lengths, refer to the *Integrator's Reference Manual for Polycom HDX Systems*.

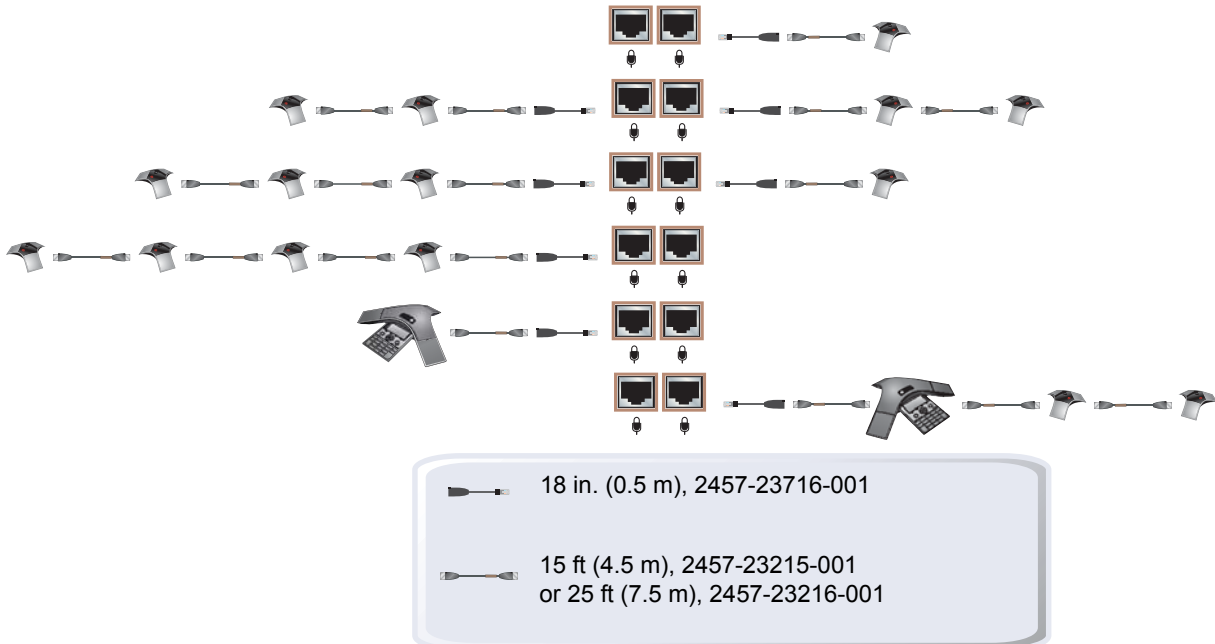

### Connecting Devices to the Polycom HDX 8000 Series Microphone Input

The Polycom HDX 8000 series system can support:

- Up to three Polycom HDX microphones (table or ceiling type).
- One SoundStation IP 7000 phone and up to two Polycom HDX microphones.
- One SoundStructure C-Series device and up to four Polycom HDX microphones.
- Polycom EagleEye View with microphones enabled.

The following diagram shows several microphone connection options for the Polycom HDX 8000 series system.

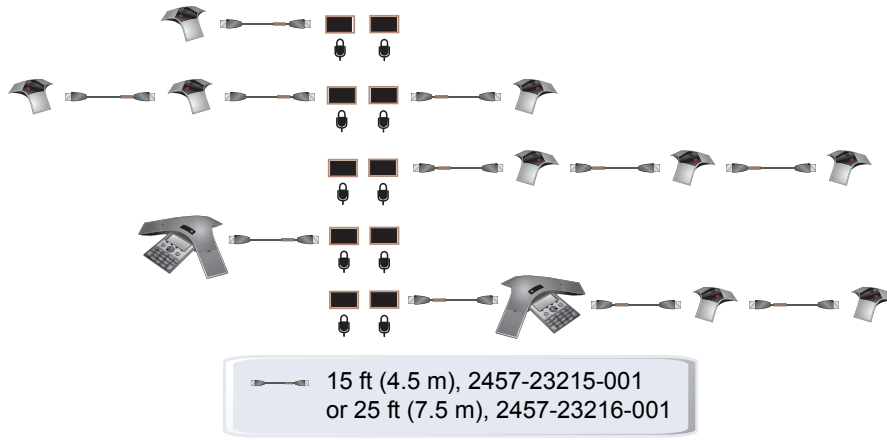

### Connecting Devices to the Polycom HDX 7000 Series Microphone Input

The Polycom HDX 7000 series systems can support:

- Up to two Polycom HDX microphones (table or ceiling type).
- One SoundStation IP 7000 phone and up to two Polycom HDX microphones.
- Polycom EagleEye View with microphones enabled.

The following diagram shows several microphone connection options for the Polycom HDX 7000 series system.



## Connecting Devices to the Polycom HDX 6000 Series Microphone Input

The Polycom HDX 6000 series systems can support:

- One Polycom HDX microphone (table or ceiling type).
- One SoundStation IP 7000 phone and up to two Polycom HDX microphones.
- Polycom EagleEye View with microphones enabled.

The following diagram shows several microphone connection options for the Polycom HDX 6000 series system.



## Connecting Devices to the Polycom HDX 4000 Series Microphone Input

The Polycom HDX 4000 series provides built-in microphones. The Polycom HDX 4000 series system also provides a headset microphone input on the side panel of the monitor. The built-in microphones are disabled when a headset is connected.

The Polycom HDX 4000 and Polycom HDX 4000 HD systems can support:





- Up to three Polycom HDX microphones (table or ceiling type)
- One SoundStation IP 7000 phone and up to two Polycom HDX microphones



The Polycom HDX 4500 system does not support Polycom HDX microphones.

## Placing Polycom Microphones to Send Stereo from Your Site

The following illustrations show microphone placement examples for different room layouts.

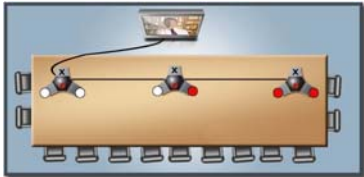
Number of Microphones with Stereo Enabled	Long Table	Wide Table
One	Mic 1 set to <b>Left+Right</b> 	Mic 1 set to <b>Left+Right</b> 
Two	Mic 1 set to <b>Left+Right</b> Mic 2 set to <b>Left+Right</b> 	Mic 1 set to <b>Left</b> Mic 2 set to <b>Right</b> 
Three	Mic 1 set to <b>Left+Right</b> Mic 2 set to <b>Left+Right</b> Mic 3 set to <b>Left+Right</b> 	Mic 1 set to <b>Left</b> Mic 2 set to <b>Left+Right</b> Mic 3 set to <b>Right</b> 
X – Not Used ○ – Left Channel ● – Right Channel		

Left and right channel assignments depend on the settings that you select on the Stereo Settings screen. If Autorotation is enabled for a microphone, the system automatically assigns active channels for the microphone. Make sure that microphones with Autorotation disabled are oriented as shown in the following illustration.



After you place the microphones, you will need to configure the system to send stereo as described in [Stereo Surround Settings](#) on page 4-19.

## Polycom Microphone Lights

The following table describes the behavior of the microphone lights on a Polycom HDX table microphone.

Microphone Light	Status
Off	Not in a call
Green	In a call, mute off
Red	Mute on
Amber	Firmware upload

## Connecting Non-Polycom Microphones or a Mixer to a Polycom HDX System

You can connect non-Polycom microphones directly to audio input 1 on a Polycom HDX 9004, Polycom HDX 9002, or Polycom HDX 9001 system, or through a line-level mixer to the AUX audio input on any Polycom HDX 9000 series, Polycom HDX 8000 series, or Polycom HDX 7000 series system. For more information about configuring these non-Polycom microphones, refer to [Settings for Non-Polycom Microphones](#) on page 4-22.

You can connect several microphones to a Polycom HDX 9000 series, Polycom HDX 8000 series, Polycom HDX 7000 series, or Polycom HDX 6000 series system through a Polycom audio mixer. The SoundStructure C-Series mixer connects to the digital microphone connector on a Polycom HDX system, and no configuration is necessary.

The Polycom Vortex® mixer connects directly to audio input 1 on a Polycom HDX 9000 series system or the AUX audio input on a Polycom HDX 8000 series or Polycom HDX 7000 series system. For more information about configuring the Polycom HDX system to use a Polycom Vortex mixer, refer to [Polycom HDX System Settings for a Polycom Vortex Mixer](#) on page 4-21.

Connecting a Polycom audio mixer to Polycom HDX systems provides flexibility in audio setup. For example, it allows you to provide a microphone for each call participant in a boardroom. Refer to the *Integrator's Reference Manual for Polycom HDX Systems* for connection details.



**Points to note about the SoundStructure digital mixer:**

- Connect a SoundStructure digital mixer using the digital microphone input on the Polycom HDX system.
- Adjusting the volume on a Polycom HDX system changes the volume of the SoundStructure digital mixer that is connected.
- The following configuration settings are not available on a Polycom HDX system when a SoundStructure digital mixer is connected: Audio input 1 (Line In), Bass, Treble, Enable Polycom Microphones, Enable MusicMode, and Enable Keyboard Noise Reduction.
- The Polycom HDX system Line Output is muted when a SoundStructure digital mixer is connected.
- All echo cancellation is performed by the SoundStructure digital mixer.

## Connecting Audio Output

You must connect at least one speaker to Polycom HDX 9000 series, Polycom HDX 8000 series, Polycom HDX 7000 series, and Polycom HDX 6000 series systems in order to hear audio. You can use the speakers built into the main monitor, or you can connect an external speaker system such as the Polycom StereoSurround kit to provide more volume and richer sound in large rooms.

When you connect a SoundStation IP 7000 conference phone to a Polycom HDX system, the conference phone becomes another way to dial audio or video calls. The conference phone also operates as a microphone, and as a speaker in audio-only calls. For more information, refer to the *Integration Guide for the Polycom® SoundStation® IP 7000 Conference Phone Connected to a Polycom® HDX® System in Unsupported VoIP Environments* and *User Guide for the Polycom® SoundStation® IP 7000 Phone Connected to a Polycom HDX® System in Unsupported VoIP Environments* on the Polycom web site.

Refer to your system's setup sheet for connection details. Make sure that the system is powered off before you connect devices to it.



## Connecting Speakers to Polycom HDX 9000 Series Systems

The following table describes the audio outputs of the Polycom HDX 9000 series system.

Audio Output Number	Connector	Output Type	Audio Mix Routed to the Output
<b>1 (Main Audio)</b>	Phoenix	Mono/Stereo	System tones and sound effects + Audio from the far site + Content audio connected to audio input 3 (and 4 for Polycom HDX 9004)
<b>3 (VCR/DVD Player)</b>	Phoenix	Mono/Stereo	Near-site talkers + Audio from the far site + Content audio connected to audio input 3 (and 4 for Polycom HDX 9004)

## Connecting Speakers to Polycom HDX 8000 Series or Polycom HDX 7000 Series Systems

The following table describes the audio outputs of the Polycom HDX 8000 series or Polycom HDX 7000 series system.

Audio Output Number	Connector	Output Type	Audio Mix Routed to the Output
<b>1 (Main Audio)</b>	RCA	Mono/Stereo	System tones and sound effects + Audio from the far site + Content audio connected to audio input 3
<b>3 (VCR/DVD Player)</b>	RCA	Mono/Stereo	Near-site talkers + Audio from the far site + Content audio connected to audio input 3

## Connecting Speakers to Polycom HDX 6000 Series Systems

The following table describes the audio outputs of the Polycom HDX 6000 series system.

Audio Output	Connector	Output Type	Audio Mix Routed to the Output
<b>Main Audio (Digital)</b>	HDMI	Mono/Stereo	System tones and sound effects + Audio from the far site + Content audio connected to PC audio input
<b>Main Audio (Analog)</b>	RCA	Mono/Stereo	System tones and sound effects + Audio from the far site + Content audio connected to PC audio input

When the video output format is set to HDMI, you can get audio output from the HDMI or RCA connectors, but Polycom recommends that you connect only one source at a time. When the video output format is set to DVI, you can get audio output from the RCA connectors only.

## Connecting Speakers to Polycom HDX 4500 Systems

The following table describes the audio outputs of the Polycom HDX 4500 system.

Audio Output Number	Connector	Output Type	Audio Mix Routed to the Output
<b>1 (Main Audio)</b>	RCA	Mono/Stereo	System tones and sound effects + Audio from the far site + Content audio connected to PC audio input

## Connecting Speakers or Headphones to Polycom HDX 4000 Series Systems

You can connect desktop speakers to provide better audio for the Polycom HDX 4000 series if you place it in a large room, or you can connect headphones to listen to calls privately. The Polycom HDX 4000 series connector for desktop speakers or headphones is on the side panel of the monitor. The built-in speakers are disabled when desktop speakers or headphones are connected.

## Placing Speakers to Play Stereo from Far Sites

The Polycom StereoSurround kit is designed for use with Polycom HDX 9000 series, Polycom HDX 8000 series, Polycom HDX 7000 series, Polycom HDX 6000 series, and Polycom HDX 4500 systems. It includes two speakers and a subwoofer.

When you set up the system for StereoSurround, the left microphone and speaker should be on the left from the local room perspective. Place the speaker connected to the audio system's right channel on the right side of the

system, and the other speaker on the left side. The system reverses the left and right channels for the far site, as shown in the following illustration. This ensures that the sound comes from the appropriate side of the room.

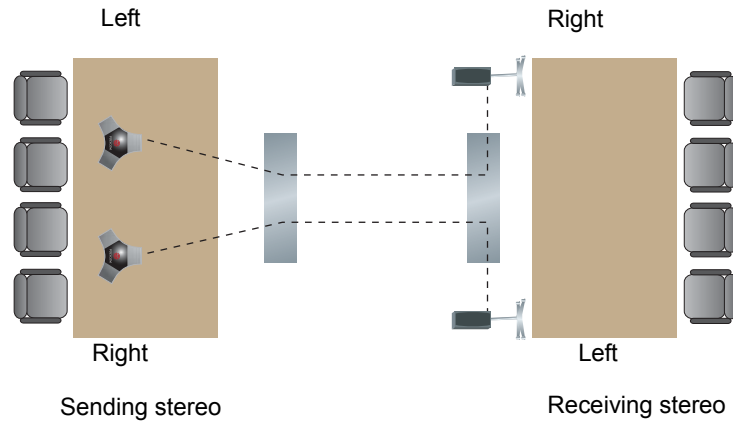

For best results, place the speakers about 60° apart as seen from the center of the conference table.

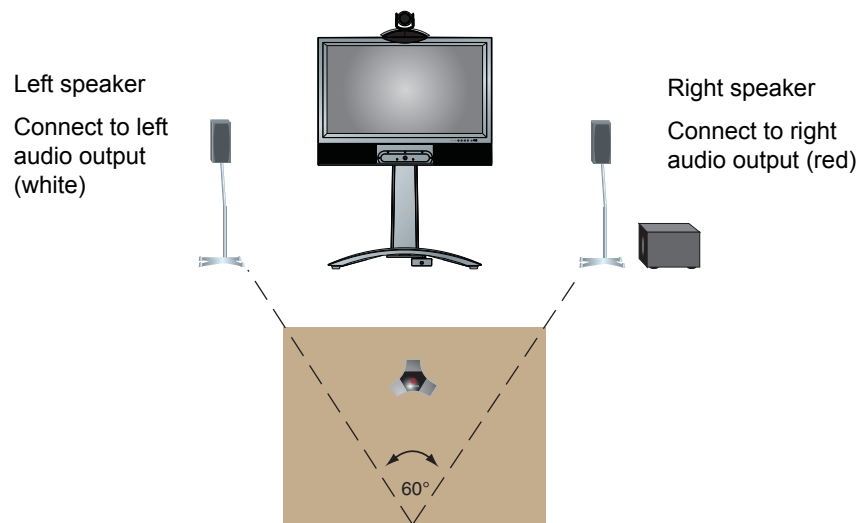

If you use the subwoofer in the Polycom StereoSurround kit, place it beside a wall or in a corner near the speakers.

## Setting the Speaker Volume

**To set the volume of an external speaker system:**

- 1 Go to **System > Diagnostics > Audio > Speaker Test**.
- 2 Start the speaker test.

- 3 Adjust the volume of the speaker system. From the center of the room the test tone should be as loud as a person speaking loudly, about 80-90 dBA on a sound pressure level meter.

## Configuring Audio Settings

### General Audio Settings



Some audio settings are unavailable when a SoundStructure digital mixer is connected to the Polycom HDX system. For more information, refer to [Connecting Non-Polycom Microphones or a Mixer to a Polycom HDX System](#) on page 4-9.

#### To configure general audio settings:

- 1 Do one of the following
  - In the local interface, go to **System > Admin Settings > Audio > Audio Settings** (select  if necessary).
  - In the web interface, go to **Admin Settings > Audio Settings**.
- 2 Configure these settings on the Audio Settings screen:

Setting	Description
<b>Sound Effects Volume</b>	Sets the volume level of the ring tone and user alert tones.
<b>Incoming Video Call</b>	Specifies the ring tone used for incoming calls.
<b>User Alert Tones</b>	Specifies the tone used for user alerts.
<b>Mute Auto Answer Calls</b>	Specifies whether to mute incoming calls. Incoming calls are muted by default until you press the mute button on the microphone or on the remote control.
<b>Enable Built-In Microphones</b> Polycom HDX 4500 Polycom HDX 4000 HD Polycom HDX 4000	Specifies whether the built-in microphones of the Polycom HDX 4000 series display are enabled.
<b>Internal Speaker</b> Polycom HDX 4500 Polycom HDX 4000 HD Polycom HDX 4000	Specifies whether to use the internal speakers. This setting is selected by default, which means that the internal speakers are unmuted and being used. If this setting is not selected, the internal speakers are muted.

Setting	Description
<b>Enable Polycom Microphones</b> Polycom HDX 9006 Polycom HDX 9004 Polycom HDX 9002 Polycom HDX 9001 Polycom HDX 8000 HD Polycom HDX 7000 HD Polycom HDX 7000 Polycom HDX 6000 HD Polycom HDX 4000 HD Polycom HDX 4000	Specifies whether microphones attached to the system's microphone input are enabled.
<b>Enable MusicMode</b>	Specifies whether the system transmits audio using a configuration that best reproduces live music picked up by microphones.  <b>Note:</b> Noise suppression, automatic gain control, and keyboard noise reduction are disabled when this setting is enabled.
<b>Enable Keyboard Noise Reduction</b>	Specifies whether the system mutes audio from any site when keyboard tapping sounds are detected but no one is talking at that site.  <b>Note:</b> MusicMode is disabled when this setting is enabled. Keyboard Noise Reduction is not available if an audio mixer is used.
<b>Enable Polycom EagleEye View Microphones</b>	Specifies whether the Polycom EagleEye View built-in microphones are enabled.

#### To configure audio input/output settings:

- 1 Do one of the following:
  - In the local interface, go to **System > Admin Settings > Audio > Inputs/Outputs** (select  if necessary).
  - In the web interface, go to **Admin Settings > Audio Settings**.

**2** Configure these settings:

Setting	Description
<p><b>Input Type</b>                      Polycom HDX 9004                      Polycom HDX 9002                      Polycom HDX 9001</p>	<p>Specifies the type of equipment that is connected to audio input 1.                      (Polycom HDX 9000 series only) Choose <b>Line Input</b> unless you have connected microphones that do not have an external preamplifier. Choose <b>Microphone</b> for most wired microphones. When set to <b>Microphone</b>, and <b>Enable Phantom Power</b> is enabled, the input provides 48V of phantom power.</p>
<p><b>Input Type Level</b>                      Polycom HDX 9006                      Polycom HDX 9004                      Polycom HDX 9002                      Polycom HDX 9001                      Polycom HDX 8000 HD                      Polycom HDX 7000 HD                      Polycom HDX 7000</p>	<p>Sets the volume level for audio input 1.</p>
<p><b>Echo Canceller</b>                      Polycom HDX 9006                      Polycom HDX 9004                      Polycom HDX 9002                      Polycom HDX 9001                      Polycom HDX 8000 HD                      Polycom HDX 7000 HD                      Polycom HDX 7000</p>	<p>Specifies whether to use the system's built-in echo canceller with audio input 1.                      Do not enable this option if you have connected a Polycom Vortex mixer.                      Note: This setting affects both the HDX microphone input and analog audio input1. When only the HDX microphone is connected, do not enable this option.</p>
<p><b>Content Input Level</b>                      Polycom HDX 9006                      Polycom HDX 9004                      Polycom HDX 8000 HD                      Polycom HDX 7000 HD                      Polycom HDX 7000                      Polycom HDX 6000 HD                      Polycom HDX 4500                      Polycom HDX 4000 HD                      Polycom HDX 4000</p>	<p>Specifies the volume level for audio input 4 of a Polycom HDX 9000 series or Polycom HDX 8000 series system. Specifies the volume level for audio input 3 of a Polycom HDX 7000 series system. Specifies the volume level for the PC audio input of a Polycom HDX 6000 series or Polycom HDX 4000 series.</p>
<p><b>Enable Phantom Power</b>                      Polycom HDX 9004                      Polycom HDX 9002                      Polycom HDX 9001</p>	<p>Allows the system to supply power to microphones connected directly to the audio input.                      Note: This selection is only available when you set Input Type to Microphone.</p>
<p><b>Input Type (dB meter)</b></p>	<p>Lets you see the peak input signal level present at audio input 1.</p>

Setting	Description
<b>Built-In Microphones (dB meter)</b> Polycom HDX 4500 Polycom HDX 4000 HD Polycom HDX 4000	Lets you see the peak input signal level present at the built-in microphones.
<b>Content Input (dB meter)</b> Polycom HDX 9006 Polycom HDX 9004 Polycom HDX 8000 HD Polycom HDX 7000 HD Polycom HDX 7000 Polycom HDX 6000 HD Polycom HDX 4500 Polycom HDX 4000 HD Polycom HDX 4000	Lets you see the peak input signal level present at the content audio input.
<b>Line Output Mode</b>	Specifies whether volume for a device connected to the audio line out connectors is variable or fixed. <ul style="list-style-type: none"> <li>• <b>Variable</b>—Allows users to set the volume with the remote control.</li> <li>• <b>Fixed</b>—Sets the volume to the Audio Level specified in the system interface.</li> </ul> <b>Note:</b> When this setting is set to <b>Fixed</b> , the remote control's or Touch Control's volume adjustment does not affect the output level of audio output 1.
<b>Level</b> Polycom HDX 9006 Polycom HDX 9004 Polycom HDX 9002 Polycom HDX 9001 Polycom HDX 8000 HD Polycom HDX 7000 HD Polycom HDX 7000 Polycom HDX 6000 HD	Sets the volume level for audio output 1 when <b>Line Output Mode</b> is set to <b>Fixed</b> .
<b>Line Out (dB meter)</b>	Lets you see the peak output signal level present at audio output 1.
<b>Line In Level</b> Polycom HDX 9006 Polycom HDX 9004 Polycom HDX 9002 Polycom HDX 9001 Polycom HDX 8000 HD Polycom HDX 7000 HD Polycom HDX 7000	Sets the volume level for audio input 3. The default setting of <b>Auto</b> configures the system for automatic gain control.

Setting	Description
<b>Line Out Level</b> Polycom HDX 9006 Polycom HDX 9004 Polycom HDX 9002 Polycom HDX 9001 Polycom HDX 8000 HD Polycom HDX 7000 HD Polycom HDX 7000	Sets the volume level for audio output 3.
<b>VCR/DVD Audio Out Always On</b> Polycom HDX 9006 Polycom HDX 9004 Polycom HDX 9002 Polycom HDX 9001 Polycom HDX 8000 HD Polycom HDX 7000 HD Polycom HDX 7000	Allows you to record a call using one VCR or DVD, while playing content into the call from a second VCR or DVD. Do not select this setting if you have only one VCR or DVD player connected. If this setting is disabled, the VCR audio output is disabled when VCR is the selected camera source.
<b>Line In Level (dB meter)</b> Polycom HDX 9006 Polycom HDX 9004 Polycom HDX 9002 Polycom HDX 9001 Polycom HDX 8000 HD Polycom HDX 7000 HD Polycom HDX 7000	Lets you see the peak input signal level present at audio input 3.
<b>Line Out Level (dB meter)</b> Polycom HDX 9006 Polycom HDX 9004 Polycom HDX 9002 Polycom HDX 9001 Polycom HDX 8000 HD Polycom HDX 7000 HD Polycom HDX 7000	Lets you see the peak output signal level present at audio output 3.
<b>Master Audio Volume</b>	Sets the volume level for audio from the far site.
<b>Bass</b>	Sets the volume level for the low frequencies without changing the master audio volume.
<b>Treble</b>	Sets the volume level for the high frequencies without changing the master audio volume.



## StereoSurround Settings

To send or receive stereo audio, make sure your Polycom HDX system equipment is set up as described in [Connecting Devices to the Polycom HDX Microphone Input](#) on page 4-3 and [Connecting Audio Output](#) on page 4-10. Then configure the system to use Polycom StereoSurround, test the system configuration, and place a test call.

If you are in a call with a far site that is sending audio in stereo mode, you can receive in stereo. In multipoint calls where some sites can send and receive stereo and some sites cannot, any site that is set up to send or receive stereo will be able to do so.



Some audio settings are unavailable when a SoundStructure digital mixer is connected to the Polycom HDX system. For more information, refer to [Connecting Non-Polycom Microphones or a Mixer to a Polycom HDX System](#) on page 4-9.

### To configure stereo settings:

- 1 Do one of the following:
  - In the local interface, go to **System > Admin Settings > Audio > Stereo Settings** (select  if necessary).
  - In the web interface, go to **Admin Settings > Audio Settings**.
- 2 Configure these settings:

Setting	Description
<b>Enable Polycom StereoSurround</b>	Specifies that Polycom StereoSurround is used for all calls.  To send or receive stereo audio, make sure your Polycom HDX system is set up as described in <a href="#">Connecting Devices to the Polycom HDX Microphone Input</a> on page 4-3 and <a href="#">Connecting Audio Output</a> on page 4-10.
<b>Polycom Microphone Type (dB meter)</b>	Lets you see the peak input signal level for Polycom microphones.

Setting	Description
<b>Stereo</b>	Positions the audio input within the left and right channels. <b>Left</b> sends all of the audio to the left channel. <b>Right</b> sends all of the audio to the right channel. For Polycom HDX digital microphones and ceiling microphones, <b>Left+Right</b> sends audio from one microphone element to the left channel and audio from a second element to the right channel.
<b>Autorotation</b>	Specifies whether autorotation is used for Polycom HDX microphones. If this feature is enabled, the system automatically assigns left and right channels for the microphone based on sound it senses from the left and right speakers. <b>Note:</b> This feature does not work when headphones are used.



## Audio Meters

The audio meters in the user interface allow you to identify left and right channels. The meters also indicate peak signal levels. Set signal levels so that you see peaks between +3 dB and +7 dB with normal speech and program material. Occasional peaks of +12 dB to +16 dB with loud transient noises are acceptable. If you see +20 on the audio meter, the audio signal is 0 dBFS and the audio might be distorted.

## Testing StereoSurround

After you configure the system to use Polycom StereoSurround, test the system configuration and place a test call.

### To test your stereo configuration:

- 1 Make sure the microphones are positioned correctly.  
Refer to [Placing Polycom Microphones to Send Stereo from Your Site](#) on page 4-8.
- 2 Do one of the following
  - In the local interface, go to **System > Admin Settings > Audio > Stereo Settings** (select  if necessary).
  - In the web interface, go to **Admin Settings > Audio Settings**.
- 3 Gently blow on the left leg and right leg of each Polycom microphone while watching the Left and Right meters to identify the left and right inputs.
- 4 Select  if necessary.

- 5 Test the speakers to check volume and verify that audio cables are connected. If the system is in a call, the far site hears the tone.

Exchange the right and left speakers if they are reversed.

Adjust the volume control on your external audio amplifier so that the test tone sounds as loud as a person speaking in the room. If you use a Sound Pressure Level (SPL) meter, it should measure about 80-90 dBA in the middle of the room.

**To make a test call in stereo using the local interface, web interface, or remote control:**

>> Do one of the following:

- Select **Polycom Austin Stereo** from the directory Sample Sites group in the local or web interface.
- Enter `stereo.polycom.com` in the dialing field and press  **Call** on the remote control or keypad.

**To make a test call in stereo using the Polycom Touch Control:**

- 1 From the Polycom Touch Control Home screen, touch **Place a Call**.
- 2 Touch **Favorites**.
- 3 Select **Polycom Austin Stereo**.

The Polycom Austin Stereo site demonstrates the stereo feature with an entertaining and informative presentation.

## Polycom HDX System Settings for a Polycom Vortex Mixer

**To configure a Polycom HDX 9000 series, Polycom HDX 8000 series, or Polycom HDX 7000 series system to use a Polycom Vortex mixer:**

- 1 (Polycom HDX 9000 series only) Do one of the following:
  - In the local interface, go to **System > Admin Settings > Audio > Inputs/Outputs** (select  if necessary).
  - In the web interface, go to **Admin Settings > Audio**.
- a** Set **Input type** to **Line Input**.
- b** Disable **Echo Canceller**.

- 2 Do one of the following:
  - In the local interface, go to **System > Admin Settings > General Settings > Serial Port** (select  if necessary).
  - In the web interface, go to **Admin Settings > General Settings > Serial Port**.
- 3 Set **RS-232 Mode** to **Vortex Mixer** for the appropriate port.

Refer to the Polycom Vortex documentation for details on configuring the mixer.

## Settings for Non-Polycom Microphones

**To configure a Polycom HDX 9004, Polycom HDX 9002, or Polycom HDX 9001 system to use devices connected directly to audio input 1:**

- 1 Do one of the following:
  - In the local interface, go to **System > Admin Settings > Audio > Inputs/Outputs** (select  if necessary).
  - In the web interface, go to **Admin Settings > Audio**
- 2 Do the following:
  - a Set **Input Type** to **Microphone**.
  - b Enable **Echo Canceller**.
  - c (Polycom HDX 9000 series only) Enable **Phantom Power** if the microphone is not amplified.
  - d Adjust the audio **Input Type Level** if necessary.
  - e Speak into the microphones that are connected to the audio line inputs. The audio meter should peak at about 5 dB for normal speech.

---

# Content and Closed Captions

You can present content during calls when you use sources such as the following:

- A VCR or DVD player connected directly to a Polycom HDX 9000 series, Polycom HDX 8000 series, or Polycom HDX 7000 series system
- People+Content IP installed on a computer, with any Polycom HDX system
- A computer connected directly to a Polycom HDX system or a Polycom Touch Control
- A USB drive connected to a Polycom Touch Control
- A Polycom UC Board connected to a supported Polycom HDX system

The following Polycom HDX systems achieve maximum content frame rate of 15 fps for 1080p with a 1080p Resolution option key installed, and 30 fps for 720p:

- Polycom HDX 9006 series
- Polycom HDX 8000 HD with Hardware Version B
- Polycom HDX 7000 HD with Hardware Versions C and D
- Polycom HDX 4500
- Polycom HDX 4000 HD with Hardware Version C



Polycom supports 1080p content only when you connect the content source to the DVI connector on the HDX system's back panel. DVI connectors are identified on HDX systems as follows:

- Polycom HDX 9000 and Polycom 8000 series: video input 4
- Polycom HDX 7000 series: video input 3
- Polycom HDX 4000 series: video input 2

Using other video inputs for content sources is not supported. If you use other video inputs for content, the content will not be 1080p and you could get unexpected results.

For more information about sharing content during a call, refer to the *User's Guide for Polycom HDX Systems*.

## Connecting VCR/DVDs

You can connect a VCR or DVD player to a Polycom HDX 9000 series, Polycom HDX 8000 series, or Polycom HDX 7000 series system to play videotapes or DVDs into calls. Or you can connect a VCR or DVD player to record your video conference. You can also connect two VCRs or DVD players, to play material and record the call at the same time.

## Configuring VCR/DVD Player Settings

You can connect a VCR or DVD player to Polycom HDX 9000 series, Polycom HDX 8000 series, or Polycom HDX 7000 series systems.

## Playing a Videotape or DVD

The VCR/DVD inputs are active when you select the camera source configured as VCR. The microphone inputs remain active while the VCR or DVD player is playing. Call participants may wish to mute the microphones while playing videotapes or DVDs.

### To configure VCR/DVD audio settings for playing a videotape or DVD:

- 1 Do one of the following:
  - In the local interface, go to **System > Admin Settings > Audio** (select  if necessary).
  - In the web interface, go to **Admin Settings > Audio**.
- 2 Set **Line In Level** for playback volume of the VCR/DVD player relative to other audio from the system.
- 3 Enable **VCR/DVD Audio Out Always On** unless you have the VCR/DVD inputs and outputs both connected to the same device to play and record.

## Recording a Call to Videotape or DVD

All audio from the near site and far site is recorded, along with the VCR/DVD Record Source video as configured on the Monitors screens. VCR and DVD video output is standard-definition format. Polycom HDX systems scale other formats to standard definition.

**To configure VCR/DVD video settings for recording a call:**



- 1 Do one of the following:
  - In the local interface, go to **System > Admin Settings > Monitors > Monitors** (select  if necessary).
  - In the web interface, go to **Admin Settings > Monitors**.
- 2 Set the aspect ratio and video format for recording.
- 3 Select one or more sources for the **VCR/DVD Record Source**.

If you select both near and far, the Polycom HDX system automatically switches recording to the site that is talking. If you select content as a record source, it is recorded (when available) regardless of who is talking. For more information about configuring VCR/DVD settings for recording a call, refer to the Monitor 3 settings described on page 3-7.



Polycom HDX systems record video in standard definition (SD) format only.

**To configure VCR/DVD audio settings for recording a call:**

- 1 Do one of the following:
  - In the local interface, go to **System > Admin Settings > Audio > Stereo Settings** (select  if necessary).
  - In the web interface, go to **Admin Settings > Audio**.
- 2 Clear **Enable Polycom StereoSurround**.
- 3 Do one of the following:
  - In the local interface, go to **System > Admin Settings > Audio > Inputs/Outputs** (select  if necessary).
  - In the web interface, go to **Admin Settings > Audio**.
- 4 Adjust the **Line Out Level** for playback volume, if necessary.
- 5 Enable **VCR/DVD Audio Out Always On** unless you have the VCR/DVD inputs and outputs both connected to the same device to play and record.

## Connecting Computers to Polycom HDX Systems

You can connect a computer directly to a Polycom HDX system. When you do this, other call participants can see everything that you see on your computer.



#### Points to note about sending content from Polycom HDX systems:



- The maximum resolution for sending content for HDX 7000 with Hardware Version C or D and HDX 8000 with Hardware Version A systems is 720p. If you connect a computer to video input 4, the maximum resolution you can set is 1680 x 1050, which is WSXGA, but the HDX 8000 system's maximum encode resolution is 1280 x 1024, which is SXGA.
- The maximum resolution for sending content for HDX 8000 with Hardware Version B and HDX 9006 systems is 1080p. However, if you use video input 2 for the camera, you will be able to send content at a maximum of only 720p for content. If you connect a computer to video input 4, the maximum resolution you can set is 1920 x 1200, but the HDX 8000 system's maximum encode resolution is 1920 x 1080.

When you connect to video and audio from your computer, the audio is muted unless the computer is selected as a video source.

For more information about connecting computers as content video sources for Polycom HDX systems, refer to [Connecting Cameras](#) on page 3-14. Refer to your system's setup sheet for connection details.

## Configuring Content Sharing

#### To configure the content display:

- 1 Do one of the following:
  - In the local interface, go to **System > Admin Settings > Monitors > Monitors** (select  if necessary).
  - In the web interface, go to **Admin Settings > Monitors**.
- 2 Select **Display Content** for the monitor that will display content (not available on the Polycom HDX 6000 series).
- 3 Do one of the following:
  - In the local interface, go to **System > Admin Settings > Network > Call Preference** (select  if necessary).
  - In the web interface, go to **Admin Settings > Network > Call Preference**.
- 4 Enable **H.239**.



You cannot enable or disable H.239 while in a call.



- 5 Do one of the following:
  - In the local interface, go to **System > Admin Settings > Audio > Inputs/Outputs** (select  if necessary).
  - In the web interface, go to **Admin Settings > Network > Audio**.
- 6 Set the **Content Input Level** (not available on the Polycom HDX 9002 or Polycom HDX 9001 systems).

## Sending Analog and Digital Content

If you have one content input on an HDX system connected to both an analog source (VGA) and digital source (DVI) using a break-out cable, the HDX system gives the digital source precedence when sending content. To send content from the analog source, disconnect both sources, wait 10 seconds, and then reconnect the analog source only.

## Configuring Content Display with People+Content IP

People+Content IP enables a presenter to show content from a computer to other sites in a video conference using only an IP network connection. The presenter can show PowerPoint® slides, video clips, spreadsheets, or any other type of content from a computer. People+Content IP supports any computer desktop resolution with color set to 16-bit or higher.



People+Content IP is unavailable when your Security Profile is set to Maximum.

Before a presenter can use a computer to show content with People+Content IP, you need to:

- Download the People+Content IP software application from the Polycom web site to the computer or computers that the presenter will use to show content.

You don't need to change the computer resolutions and you don't need special cables or hardware, but each computer must meet these requirements:

- Operating System: Windows 2000, Windows XP Home, Windows XP Professional, Windows Vista, and Windows 7
- Minimum computer: 500 MHz Pentium® III (or equivalent); 256 MB memory  
Recommended computer: 1 GHz Pentium III (or equivalent); 512 MB memory
- Connect the computer or computers to the IP network.

**To install People+Content IP on a computer:**

- 1 On a computer, open a web browser and go to the Polycom web site at [www.polycom.com/ppcip](http://www.polycom.com/ppcip).
- 2 Download and install the People+Content IP software.



If the Polycom HDX system is paired with a Polycom Touch Control, People+Content IP does not need to be installed. If you connect the PC to the USB connection on the underside of the Polycom Touch Control, a version of People+Content IP launches automatically.

## Configuring People on Content™

Polycom People on Content allows you to show yourself on top of content that you are sharing. The effect is similar to a weather report on television.



This feature is available for Polycom HDX 9000 series, Polycom HDX 8000 series, and Polycom HDX 4000 series systems. For more information about using this feature, refer to the *User's Guide for Polycom HDX Systems*.

If an EagleEye Director is connected to your HDX system, and tracking is turned on, you can use People on Content or the EagleEye Director, but you cannot use them at the same time.

## Setting Up the Room for People on Content

For the best results, follow these guidelines for People on Content:

- Polycom recommends using the Polycom EagleEye III camera when setting up Polycom HDX 9000 series and Polycom HDX 8000 series systems to use People on Content, although you can also use the Polycom EagleEye HD and Polycom EagleEye 1080 cameras. Activating People on Content automatically reduces a Polycom HDX system's resolution to 720p.

- Create a flat, consistent background color using a screen or matte-finish paint in green or blue. Make sure that the background does not have shadows or glare.
- Make sure that the background and the presenter are well lit. For example, use a minimum of two 250 W halogen lights on the background and one on the presenter.
- Experiment with different room arrangements, lighting, and backgrounds.

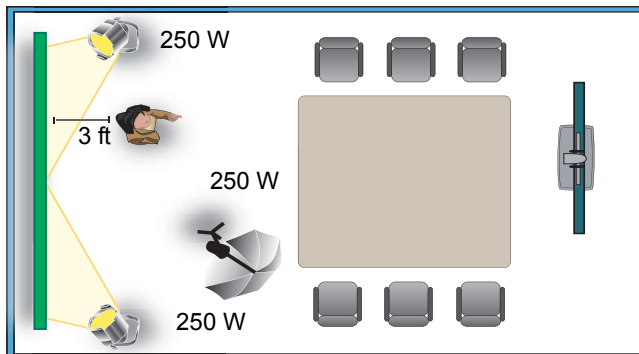

## Enabling and Calibrating People on Content on the System

Before using People on Content, configure and calibrate the system so that presenters can use People on Content during calls.

### To configure and calibrate the system for People on Content:

- 1 Do one of the following:
  - In the local interface, go to **System > Admin Settings > Cameras > People on Content**.
  - In the web interface, go to **Admin Settings > Cameras**.
- 2 Configure these settings:

Setting	Description
<b>Foreground Source</b>	Specifies Camera 1 as the video source to display on top of the background content.
<b>Background Content Source</b>	Specifies the content video source to use for the background image when using People on Content. Only cameras configured as <b>Content</b> are available as a Background Content Source. People+Content IP cannot be used as a background content source.

- 3 Follow the instructions on the screen to calibrate the camera for People on Content. Calibration does the following:
  - A camera preset is created for the green screen area.
  - The camera calibrates to the background color.

## Manually Setting White Balance

When you use People on Content, the automatic setting for white balance might not provide a suitable picture. You can alleviate this problem by changing the white balance setting manually using the steps starting on page 3-34. Polycom recommends that you use the White Balance setting choice that best matches the room lighting where your HDX system is located.

## Configuring UC Board™

With the Polycom UC Board, you can show and annotate content in real-time from Polycom HDX systems by using the stylus and receiver included with the UC Board hardware. You can use either a second monitor or a whiteboard and projector.



The UC Board is an integrated application that works with the following systems and hardware versions:

- Polycom HDX 9006 system
- Polycom HDX 8000 HD system with Hardware Version B
- Polycom HDX 7000 HD system with Hardware Versions C and D

**To connect UC Board to a USB hub:**

A USB 2.0 hub is required for connecting the Polycom UC Board.

- 1 Connect a USB 2.0 hub to the USB port of the HDX system.



You can extend the reach of the USB connector on the HDX system by installing an active USB extension cable.

- 2 Connect the UC Board receiver to one of the ports of this hub.

**To set up two monitors and configure to show content:**

Two monitors are required to use the Polycom UC Board. The second monitor can be either a projector used with a whiteboard, or a monitor.

- 1 To configure monitor 1, go to **System > Admin Settings > Monitors**. On the monitor 1 screen, enable **Display Near Video** and **Display Far Video**.
- 2 To configure monitor 2:
  - Advance to the Monitor 2 screen and set **Resolution** to either 720p or 1080p.
  - Enable **Display Content** to show shared content and Polycom UC Board annotations.

To improve performance, configure your monitor or projector to use **Game Mode**, if that setting is available.

For more information on setting up and getting started with the UC Board, refer to the *Quick Start Guide for the Polycom UC Board*, available with the UC Board hardware and at [support.polycom.com](http://support.polycom.com). For information about using the UC Board, refer to the *User's Guide for Polycom HDX Room Systems*, which is also available at [support.polycom.com](http://support.polycom.com).

## Configuring Closed Captioning

You can provide real-time text transcriptions or language translations of the video conference by displaying closed captions on your system. When you provide captions for a conference, the captioner may be present, or may use a telephone or web browser to listen to the conference audio. When the captioner sends a unit of text, all sites see it on the main monitor for 15 seconds. The text then disappears automatically.

Closed captions are supported between Polycom HDX systems with any software version, including an HDX system hosting a multipoint call, and Polycom VSX® systems with software version 7.0 or later.

Captions may be provided in any language that uses the Latin alphabet.

Depending on the capabilities of the system, the captioner may enter caption text using one of the following methods:

- Remotely, via a dial-up connection to the system's serial RS-232 port
- In the room using equipment connected directly to the serial port
- In the room or remotely, using the Polycom HDX web interface

## Via a Dial-Up Connection to the Systems' RS-232 Serial Port

Closed captioners can provide captions from inside the conference room, or from a remote location, via a dial-up connection to the serial port of the Polycom HDX 9000 series, Polycom HDX 8000 series, or Polycom HDX 7000 series system, as shown in the following diagram.

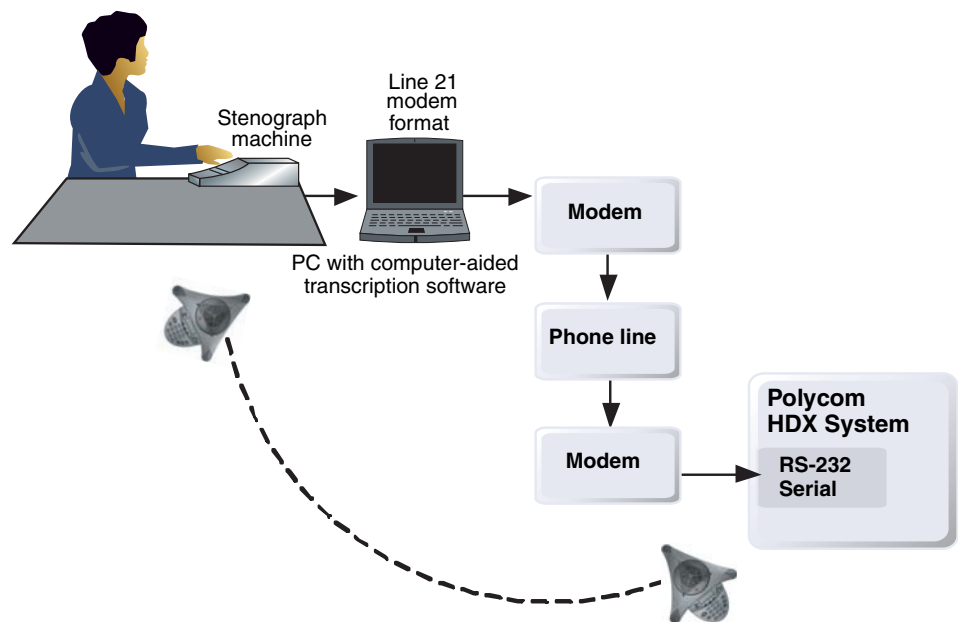

### To supply closed captions via a dial-up connection:

- 1 Ensure that the computer and the Polycom HDX system are configured to use the same baud rate and parity settings.
- 2 Do one of the following:
  - In the local interface, go to **System > Admin Settings > General Settings > Serial Port** (select  if necessary).
  - In the web interface, go to **Admin Settings > General Settings > Serial Port**.
- 3 Set the RS-232 Mode to **Closed Caption**.

- 4 Establish a dial-up connection between the computer and the Polycom HDX system.
  - a Connect a null modem adapter to the RS-232 serial port.
  - b Connect an RS-232 cable to the modem and to the null modem adapter.
  - c Connect the modem to a phone line.
  - d Configure the modem for 8 bits, no parity.

You may need to configure the modem to answer automatically. You may also need to configure it to ignore DTR signals.

- 5 On the computer, start the transcription application.
- 6 Enter text using the stenographic machine connected to the computer.
- 7 To stop sending closed captions, close the transcription application.

## Via the System's Serial RS-232 Port

Closed captioners can provide captions from inside the conference room, using equipment connected directly to the serial port of the Polycom HDX 9000 series, Polycom HDX 8000 series, or Polycom HDX 7000 series system, as shown in the following diagram.

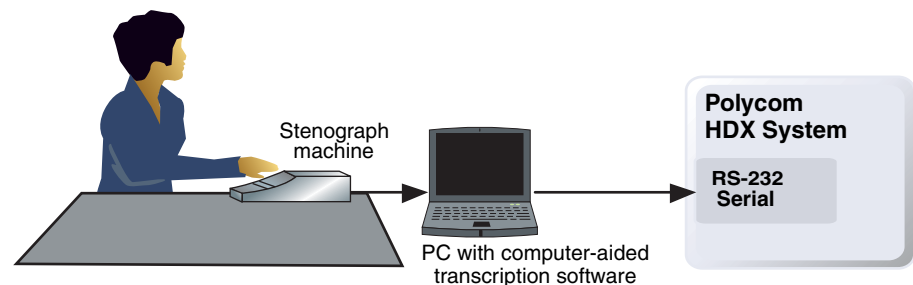

### To supply closed captions using equipment connected directly to the serial port:

- 1 Ensure that the computer and the Polycom HDX system are configured to use the same baud rate and parity settings.
- 2 Do one of the following:
  - In the local interface, go to **System > Admin Settings > General Settings > Serial Port** (select  if necessary).
  - In the web interface, go to **Admin Settings > General Settings > Serial Port**.
- 3 Set the RS-232 mode to **Closed Caption**.
- 4 On the computer, start the transcription application.

- 5 Enter text using the stenographic machine connected to the computer.
- 6 To stop sending closed captions, close the transcription application.

## Via the Polycom HDX Web Interface

Closed captioners can provide captions from inside the conference room, or from a remote location, by entering the captions directly into the Polycom HDX web interface, as shown in the following diagram.

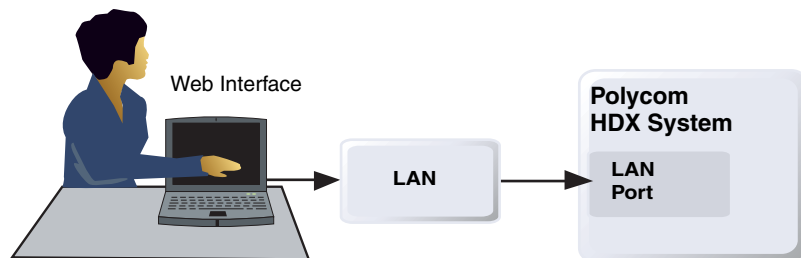

### To supply closed captions for a conference using the Polycom HDX web interface:

- 1 In your web browser address line, enter the HDX system's IP address.
- 2 Go to **Utilities > Closed Caption**.
- 3 Log in using this information if prompted:  
**User Name:** Your name.  
**Password:** Meeting password defined for your video conferencing system.
- 4 In the Closed Caption screen, type the caption text into the text field. Text wraps to the next line after 32 characters.
- 5 Press **Send** to send the text to the sites in the conference.



# Calling and Answering

## Configuring Call Settings

The Call Settings screens provide access to high-level options for the entire system. For convenience, some of the User Settings options are repeated on these screens.

### To configure call settings:

- 1 Do one of the following:
  - In the local interface, go to **System > Admin Settings > General Settings > System Settings > Call Settings** (select  if necessary).
  - In the web interface, go to **Admin Settings > General Settings > System Settings > Call Settings**.
- 2 Configure these settings on the Call Settings screen:

Setting	Description
<b>Maximum Time in Call</b>	<p>Enter the maximum number of minutes allowed for call length.</p> <p>When that time has expired, you see a message asking you if you want to hang up or stay in the call. If you do not answer within one minute, the call automatically disconnects. If you choose to stay in the call at this time, you will not be prompted again.</p> <p>Choosing 0 removes any limit.</p> <p>This setting also applies when you are viewing the Near video screen or showing content, even if you are not in a call. If the maximum time is reached while viewing Near video, the system automatically returns to the Home screen. If content is being shown, the content stops.</p>
<b>Display Time in Call</b>	<p>Specifies whether to display the elapsed time or the local time during a call. You can also choose not to display the time.</p>

Setting	Description
<b>Call Detail Report</b>	Specifies whether to collect call data for the Call Detail Report and Recent Calls list. When selected, information about calls can be viewed through the Polycom HDX web interface and downloaded as a .csv file. <b>Note:</b> If this setting is disabled, applications such as the Polycom Global Management System will no longer retrieve new Call Detail Report (CDR) records.
<b>Recent Calls</b>	Specifies whether to display the <b>Recent Calls</b> button on the home screen. The Recent Calls screen lists the site number or name, the date and time, and whether the call was incoming or outgoing. <b>Note:</b> If the Call Detail Report option is not selected, the Recent Calls setting is not available.
<b>Allow Mixed IP and ISDN Calls</b>	Specifies whether users can make multipoint calls that include both IP and H.320 sites. This selection is only available when the system has ISDN networking capability.
<b>Far Site Name Display Time</b>	Turns the far site name display on or off, or specifies the time period the far site name appears on screen when calls first connect.
<b>Auto Answer Point-to-Point Video</b>	Specifies whether to answer incoming point-to-point calls automatically.
<b>Auto Answer Multipoint Video</b>	Specifies whether to answer incoming multipoint calls automatically. This selection is available only when the system has multipoint capability. <b>Note:</b> When this setting is enabled, you cannot put calls on hold.

## Setting the Call Answering Mode

### To set the call answering mode:

- Do one of the following:
  - In the local interface, go to **System > Admin Settings > General Settings > System Settings > Call Settings** (select  if necessary).
  - In the web interface, go to **Admin Settings > General Settings > System Settings > Call Settings**.
- Select **Auto Answer Point-to-Point Video** to set the answer mode for calls with one site, or select **Auto Answer Multipoint Video** to set the mode for calls with two or more other sites.

- 3 Select one of the following:
  - **Yes** – Answers calls automatically.
  - **No** – Enables you to answer calls manually.
  - **Do Not Disturb** – Refuses incoming calls automatically. The caller receives a message that the call is rejected.

## Configuring Multipoint Calling

You can use your Polycom HDX system to participate in multipoint conferences. Multipoint conferences include multiple video sites and can also include analog phone, Voice Over ISDN, H.323 audio-only, or SIP audio-only sites. The first analog phone or Voice Over ISDN connection does not count toward the number of sites in a call. Additional analog phone or Voice Over ISDN connections, as well as all H.323 audio-only and SIP audio-only connections, do count toward the number of sites in a call. Multipoint calls require a multipoint conferencing unit (MCU) or a hosting system. Depending on the system's configuration, Polycom HDX systems can host multipoint calls. Polycom HDX systems may also be able to use the Conference on Demand feature for multipoint calling.

You must enter a multipoint option key to enable your HDX system to host multipoint calls, but the option key does not have to be enabled to participate in multipoint calls.

For more information about multipoint calls, refer to [Configuring Multipoint Viewing Modes](#) on page 3-11 and [HD and SD Multipoint Calls](#) on page 3-38.

## Entering a Multipoint Option Key

Before placing multipoint calls, you may need to enter a multipoint option key. A five-minute multipoint trial is available.

For information about purchasing a multipoint call option, please contact your Polycom distributor.

### To enter the multipoint option key:

- 1 Do one of the following:
  - In the local interface, go to **System > Admin Settings > General Settings > Options**.
  - In the web interface, go to **Admin Settings > General Settings > Options**.
- 2 Enter the multipoint (MP) option key.

**To enable or disable multipoint trial mode:**

- 1 Do one of the following:
  - In the local interface, go to **System > Admin Settings > General Settings > Options**.
  - In the web interface, go to **Admin Settings > General Settings > Options**.
- 2 Select **Enable Multipoint Trial** to allow five-minute multipoint calling without the multipoint option key.

## Configuring the Conference on Demand Feature

If your organization uses a Polycom PathNavigator, *ReadiManager* SE200, or CMA system, you may be able to use the Conference on Demand feature to place multipoint calls with up to 10 sites, including the site that places the call.

In order to place calls using Conference on Demand, you need to:

- Register your Polycom HDX system with PathNavigator, *ReadiManager* SE200, or CMA system.
- Configure your Polycom HDX system to use Conference on Demand for multipoint calls (refer to [Configuring the System to Use a Gatekeeper](#) on page 2-9).
- Create a group in the directory that can be used to place the multipoint call.



**Points to note about Conference on Demand:**

- Once the call begins, users cannot add another site to the call, even if the site was in the call originally and is attempting to rejoin. Because of this, you cannot place cascaded multipoint calls through Conference on Demand.
- The Polycom MGC or RMX system must have enough ports available to complete the call. The system displays a message if the bridge does not have enough ports (resources) available to connect all the sites.
- RealPresence Resource Manager does not support Conference on Demand.

## Including Multiple Sites in a Cascaded Call

You can include multiple sites in a cascaded call if the sites you call have internal multipoint capability.

The following diagram shows how to do this.

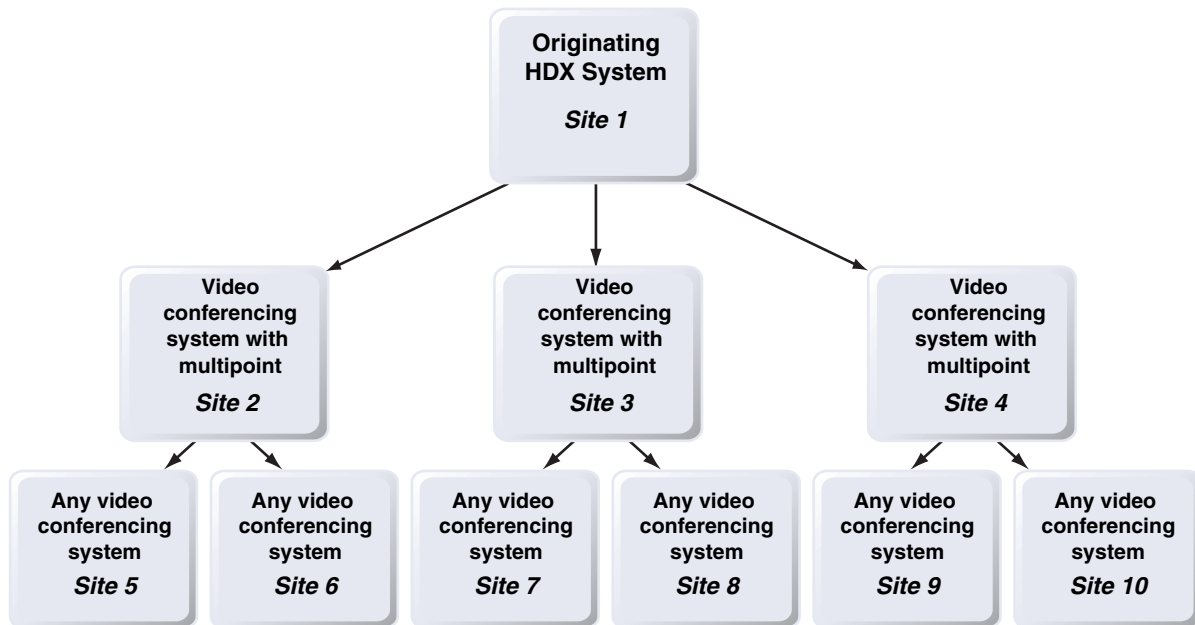

#### To place a cascaded call:

- 1 Create and call a group in the directory, or place calls one at a time to several other sites.
- 2 Ask each far site to call additional sites. Along with these additional sites, each far site in the original multipoint call can add one audio-only connection.



#### Points to note about cascaded calls:

- You cannot place cascaded multipoint calls using Conference on Demand.
- Chair control, People+Content, and H.239 are not supported in cascaded calls.
- Cascaded multipoint is not supported in SIP calls.
- HD and SD multipoint is not supported when the Polycom HDX system hosts a cascaded call.
- Only Full Screen multipoint mode is available in cascaded calls.
- The encryption padlock icon might not accurately indicate whether a cascaded call is encrypted.

## Configuring Directory Settings

### To configure system settings:

- 1 Do one of the following:
  - In the local interface, go to **System > Admin Settings > General Settings > System Settings > Directory** (select  if necessary).
  - In the web interface, go to **Admin Settings > General Settings > System Settings > Directory**.
- 2 Configure these settings on the Directory screen:

Setting	Description
<b>System Name</b>	Enter or change the system name in this field. This name appears on the screen for the far site when you are making calls.  <b>Note:</b> The first character of a System Name must be a letter or a number. The System Name cannot begin with the dollar sign (\$) or underscore (_) character.
<b>Localized System Name</b>	Displays the localized system name, if you have entered one. You can enter a <b>Localized System Name</b> for Simplified Chinese on this screen using the Chinese Virtual Keyboard. You must use the Polycom HDX web interface to enter localized system names for other languages.
<b>Preview Directory Entry Information</b>	Specifies whether to display a preview of each entry on the Directory screen.  This setting is not supported if the Polycom HDX system is paired with the Polycom Touch Control.
<b>Allow Directory Changes</b>	Specifies whether users can save changes to the directory or Favorites list.  This setting is not supported if the Polycom HDX system is paired with the Polycom Touch Control.
<b>Confirm Directory Deletions</b>	Specifies whether users are prompted to confirm deletions of directory entries.  This setting is not supported if the Polycom HDX system is paired with the Polycom Touch Control.
<b>Confirm Directory Additions Upon Call Disconnect</b>	Specifies whether users are prompted to add a new directory entry for the last site called, if the call lasted at least one minute.  This setting is not supported if the Polycom HDX system is paired with the Polycom Touch Control.

Setting	Description
<b>Search</b>	<p>Specifies the method for directory searches. If set to Auto, searches start as soon as you enter a character in the search field, and no Search button is displayed. If set to Manual, searches start when you select the  Search button.</p> <p>If the Polycom HDX system is paired with the Polycom Touch Control, searches are always automatic.</p>
<b>Display Favorites in Directory</b>	<p>Specifies whether Favorites are included in the directory of the local system interface.</p> <p>If Favorites is the only folder in the directory, Favorites appear in the directory regardless of this setting.</p> <p>The directory in the web interface always includes Favorites, regardless of this setting.</p> <p>Favorites do not display in the Polycom Touch Control Directory.</p>

## Creating a Localized System Name with the Polycom HDX Web Interface

Polycom HDX systems send the localized system name to the far site as the caller ID. The localized system name is displayed if the user interface of the far-site system is set to that same language. If the far-site system and localized system name are in different languages, the far-site system displays the English system name. The English name is the name used by the Global Directory Server, the gatekeeper, and other systems that do not support localized system names, and it is also the name that shows up in the Recent Calls list.

### To create a localized system name using the Polycom HDX web interface:

- 1 In your web browser address line, enter the HDX system's IP address.
- 2 Go to **Admin Settings > General Settings > System Settings**.
- 3 Enter the localized system name in the appropriate language field.
- 4 Click **Update**.

## Managing Directories with the Polycom HDX Web Interface

The Polycom HDX Web Interface import/export directory feature allows you to maintain consistency of Polycom HDX system directories in your organization efficiently. It is particularly useful for administrators managing multiple systems that call the same locations. You can:

- Transfer existing directory entries between Polycom HDX systems
- Develop directory entries on one system, save them to your computer, and then distribute them to other systems
- Create localized directory entries

Only Favorites directories can be downloaded. Favorites directory entries are saved to a PC in .xml format only in version 2.6. Version 2.6 or later can import .csv files saved in a previous HDX version or .xml files saved in version 2.6 or later. However, you cannot import .xml files into an older HDX version.

### To download a Polycom HDX system directory to your computer using the Polycom HDX web interface:

- 1 In your web browser address line, enter the HDX system's IP address.
- 2 Go to **Utilities > Import/Export Directory**.
- 3 Click **HDX → PC** to download the .xml file from the Polycom HDX system.
- 4 Save the file to a location on your computer.

### To upload Polycom HDX system directory entries using the Polycom HDX web interface:

- 1 In your web browser address line, enter the HDX system's IP address.
- 2 Go to **Utilities > Import/Export Directory**.
- 3 Click **PC → HDX**.
- 4 Click **Browse** and browse to the location of the .csv or .xml file on your computer.
- 5 Click **Import Directory** to upload the file to the Polycom HDX system.

### To create a localized directory entry using the Polycom HDX web interface:

- 1 In your web browser address line, enter the HDX system's IP address.
- 2 Go to **Place a Call > Directory**.
- 3 Select an entry.
- 4 Edit the entry to enter a localized directory entry name in the **Localized Name** field, and specify the language for the localized directory entry.



## Configuring the Global Directory

The global directory provides a list of other systems that are registered with the Global Directory Server and available for calls. The other systems appear in the directory, allowing users to place calls to other users by selecting their names.

You can configure the system to use one of the following directory servers in standard operating mode.

Directory Servers Supported	Authentication Protocols	Global Directory Groups	Entry Calling Information
Polycom GDS	Proprietary	Not Supported	May include: <ul style="list-style-type: none"> <li>H.323 IP address (raw IPv4 address, DNS name, or H.323 extension)</li> <li>ISDN number</li> </ul>
LDAP with H.350 or Active Directory	Any of the following: <ul style="list-style-type: none"> <li>NTLM</li> <li>Basic</li> <li>Anonymous</li> </ul>	Not Supported	May include: <ul style="list-style-type: none"> <li>H.323 IP address (raw IPv4 or IPv6 address, DNS name, H.323 dialed digits, H.323 ID, or H.323 extension)</li> <li>SIP address (SIP URI)</li> <li>ISDN number</li> <li>Phone number*</li> </ul>
Microsoft Office Communications Server 2007 R2	NTLM	Contact groups but not distribution lists	May include: <ul style="list-style-type: none"> <li>SIP address (SIP URI)</li> </ul>
Microsoft Lync Server 2010	NTLM v2 encryption, up to 128 bit	Contact groups but not distribution lists	May include: <ul style="list-style-type: none"> <li>SIP address (SIP URI)</li> </ul>
* To successfully call a phone number from the LDAP directory, the phone number must be stored in one of the following formats: <ul style="list-style-type: none"> <li>+Country Code.Area Code.Number</li> <li>+Country Code.(National Direct Dial Prefix).Area Code.Number</li> </ul>			

You can configure the system to use one of the following directory servers when the system is automatically provisioned by a Polycom CMA or RealPresence Resource Manager system.

Directory Servers Supported	Authentication Protocol	Global Directory Groups	Entry Calling Information
LDAP by a Polycom CMA or RealPresence Resource Manager system	NTLM only	Pre-defined groups from the LDAP directory are shown in Polycom HDX system's directory	May include: <ul style="list-style-type: none"> <li>H.323 dialed digits, H.323 ID, or H.323 extension</li> <li>Phone number*</li> </ul>

Directory Servers Supported	Authentication Protocol	Global Directory Groups	Entry Calling Information
Microsoft Office Communications Server 2007 R2	NTLM	Contact groups but not distribution lists	May include: <ul style="list-style-type: none"> <li>SIP address (SIP URI)</li> </ul>
Microsoft Lync Server 2010	NTLM	Contact groups but not distribution lists	May include: <ul style="list-style-type: none"> <li>SIP address (SIP URI)</li> </ul>
<p>* To successfully call a phone number from the LDAP directory, the phone number must be stored in one of the following formats:</p> <ul style="list-style-type: none"> <li>+Country Code.Area Code.Number</li> <li>+Country Code.(National Direct Dial Prefix).Area Code.Number</li> </ul>			

**To choose a directory server:**

- 1 Do one of the following:
  - In the local interface, go to **System > Admin Settings > Global Services > Directory Servers** (select  if necessary).
  - In the web interface, go to **Admin Settings > Global Services > Directory Servers**.
- 2 Enable **LDAP, Polycom GDS, Microsoft Office Communications Server, or Microsoft Lync Server**.

**To configure the Polycom GDS settings:**

- 1 Do one of the following:
  - In the local interface, go to **System > Admin Settings > Global Services > Directory Servers** (select  if necessary) and select the **Edit** button to the right of **Polycom GDS**.
  - In the web interface, go to **Admin Settings > Global Services > Directory Servers** and select **Polycom GDS**.

2 Configure these settings on the Global Directory Servers screen:

Setting	Description
<b>Global Directory (GDS)</b>	Specifies the IP address or DNS address of the Global Directory Server. You can enter up to five addresses.
<b>Password</b>	Lets you enter the global directory password, if one exists.
<b>Register</b>	Registers this system with the Global Directory Server.
<b>Display Global Addresses</b>	Displays other registered systems in the global directory.
<b>Display Name in Global Directory</b>	Specifies whether to display the system's name in the global directories of other registered systems.
<b>Save Global Directory to System</b>	When enabled, this setting allows Polycom HDX systems to display global entries in the directory in case the system loses connection with the Polycom GDS Directory.
<b>Group Name</b>	Specifies the group name used for Polycom GDS directory entries in your directory. The default name for the Polycom GDS group is <b>Global Directory</b> .



**To configure the LDAP settings:**

- Do one of the following:
  - In the local interface, go to **System > Admin Settings > Global Services > Directory Servers** (select  if necessary) and select the **Edit** button to the right of **LDAP**.
  - In the web interface, go to **Admin Settings > Global Services > Directory Servers** and select **LDAP**.
- Configure these settings on the LDAP screen.

LDAP Setting	Description
<b>Server Address</b>	Specifies the address of the LDAP directory server. With Automatic Provisioning, this setting is configured by the server and appears as read-only.
<b>Server Port</b>	Specifies the port used to connect to the LDAP server. With Automatic Provisioning, this setting is configured by the server and appears as read-only.
<b>Group Name</b>	Specifies the group name used for LDAP directory entries in your directory. The default name for the LDAP group is <b>Global Directory</b> .
<b>Base DN (Distinguished Name)</b>	Specifies the top level of the LDAP directory where searches will initiate. With Automatic Provisioning, this setting is configured by the server and appears as read-only.

LDAP Setting	Description
<b>Authentication Type</b>	Specifies the protocol used for authentication with the LDAP server: NTLM, BASIC, or Anonymous.
<b>Use SSL (Secure Socket Layer)</b>	Enables SSL for securing data flow to and from the LDAP server.
<b>Domain Name</b>	Specifies the domain name for authentication with the LDAP server.
<b>User Name</b>	Specifies the user name for authentication with LDAP server.
<b>Password</b>	Specifies the password for authentication with the LDAP server. <b>Note:</b> On the web interface, this field is named <b>NTLM Password</b> .

**To configure the Microsoft Office Communications Server or Microsoft Lync Server directory settings:**

- 1 Do one of the following:
  - In the local interface, go to **System > Admin Settings > Network > IP > SIP Settings** (select  if necessary).
  - In the web interface, go to **Admin Settings > Network > IP > SIP Settings**.
- 2 Configure the SIP settings as described in [Specifying SIP Settings](#) on page 2-15.
- 3 Do one of the following:
  - In the local interface, go to **System > Admin Settings > Global Services > Directory Servers** (select  if necessary) and select the **Edit** button to the right of **Microsoft Lync Server 2010**.
  - In the web interface, go to **Admin Settings > Global Services > Directory Servers** and select **Microsoft Lync Server 2010**.
- 4 Configure these settings on the Microsoft Lync Server 2010 screen.

Setting	Description
<b>Registration Status</b>	Indicates whether the system is successfully registered with the Microsoft Office Communications Server or Microsoft Lync Server. <b>Note:</b> This setting is read only.
<b>Domain Name</b> (web only)	Indicates the Domain Name entered on the SIP Settings screen.

Setting	Description
<b>Domain User Name</b>	Indicates the Domain User Name entered on the SIP Settings screen. <b>Note:</b> This setting is read only.
<b>User Name</b>	Indicates the User Name entered on the SIP Settings screen. <b>Note:</b> This setting is read only.
<b>Display Contacts</b>	Specifies whether to display Microsoft Office Communications Server or Microsoft Lync Server contacts on the Favorites screen and in the directory. Office Communicator contacts that are Favorites do not appear in the directory when the Polycom HDX system is paired with a Polycom Touch Control.
<b>Show My Offline Contacts</b>	Specifies whether to include offline Microsoft Office Communications Server or Microsoft Lync Server contacts on the Favorites screen and in the directory.
<b>Group Name</b>	Specifies the group name used for Microsoft Office Communications Server or Microsoft Lync Server entries in the directory. The default name for the group is <b>Global Directory</b> .

## Directory Groups

Having groups in the directory can help users find calling information quickly and easily. Polycom HDX systems support global groups and Favorites groups.

Polycom HDX systems support up to 1,000 Favorites that users create within Favorites after registering their directory service. It can also support one of the following:

- Up to 200 additional contacts with presence, which appear in Favorites, when registered with Microsoft Office Communications Server 2007 R2 or Microsoft Lync Server 2010.
- Up to 200 additional contacts with presence, which appear in Favorites, when registered with a Polycom CMA or RealPresence Resource Manager system.
- Up to 4,000 contacts from up to 5 servers, which appear in the Global Directory group, when registered with a Polycom GDS system.
- Up to 20,000 contacts when the HDX system is registered with Microsoft Office Communications Server 2007 R2 or Microsoft Lync Server 2010.

Polycom HDX systems support up to 200 Favorites groups that users create within Favorites. If the system is connected to a global directory server, it can also support one of the following:

- Up to 64 additional groups from the Microsoft Office Communications Server or Microsoft Lync Server, which appear in the Favorites group.
- Up to 200 additional distribution groups from Polycom CMA or RealPresence Resource Manager systems, which appear in the Global Directory group.

## Global Directory Groups

Global directory entries are assigned to a global group with the name that you specify in the Directory Server configuration. Up to 200 search results can be displayed at a time from an LDAP or Microsoft global directory. Users cannot edit or delete global directory entries or global directory groups.

## Favorites Group

The Favorites group contains the types of Contacts shown in the following table.

Directory Server Registration	Types of Contacts	Presence State Displayed
Polycom GDS	<ul style="list-style-type: none"> <li>• Directory entries created locally by the user.</li> </ul>	Unknown
	<ul style="list-style-type: none"> <li>• References to Polycom GDS entries added to Favorites by the user.</li> </ul> <p>These entries are only available if the system is successfully registered with Polycom GDS. These entries can be deleted from Favorites by the user. These entries can be copied to other Favorites groups and removed from those groups by the user. These entries cannot be edited by the user.</p>	Online/Offline
LDAP with H.350 or Active Directory	<ul style="list-style-type: none"> <li>• Directory entries created locally by the user</li> <li>• References to LDAP directory entries added to Favorites by the user.</li> </ul> <p>These entries are only available if the system can successfully access the LDAP/Active Directory server. These entries can be deleted from Favorites by the user. These entries can be copied to other Favorites groups and removed from those groups by the user. These entries cannot be edited by the user.</p>	Unknown

Directory Server Registration	Types of Contacts	Presence State Displayed
LDAP by a Polycom CMA or RealPresence Resource Manager System	<ul style="list-style-type: none"> <li>• Directory entries created locally by the user.</li> <li>• References to LDAP directory entries added to Favorites by the user.</li> </ul> <p>These entries are only available if the system can successfully access the Polycom CMA or RealPresence Resource Manager system. These entries can be deleted from Favorites by the user. These entries can be copied to other Favorites groups and removed from those groups by the user. These entries cannot be edited by the user.</p>	Unknown
	<ul style="list-style-type: none"> <li>• LDAP directory entries saved as Favorites by the user and stored with the presence service.</li> </ul> <p>These entries can be deleted from Favorites by the user. These entries can be copied to other Favorites groups and removed from those groups by the user. These entries cannot be edited by the user.</p>	Real-time presence
Microsoft	<ul style="list-style-type: none"> <li>• Microsoft Office Communications Server or Microsoft Lync Server directory entries saved as Contacts by the user in Office Communicator and stored on the Microsoft Office Communications Server or Microsoft Lync Server.</li> </ul> <p>Users must create their contact lists using Microsoft Office Communicator on a computer. These entries cannot be edited or deleted from Favorites using the Polycom HDX system. These entries can be copied to other Favorites groups and removed from those groups by the user.</p>	Real-time presence

Users can create, edit, and delete Favorites entries and Favorites groups.

## Polycom Conferencing for Microsoft Outlook

Polycom HDX systems can connect to Microsoft Exchange Server 2007 or 2010 and retrieve calendar information. Connecting to a calendaring service allows the Polycom HDX system to:

- Display the day's scheduled meetings, along with details about each.
- Hide or show details about meetings marked Private, depending on the configuration of the system.

- Display a meeting reminder before each scheduled meeting, along with a reminder tone.

In addition, if the meeting was created using the Polycom Conferencing Add-in for Microsoft Outlook, the Polycom HDX system can:

- Identify video-enabled meetings with an icon displayed on the system calendar.
- Let users join the meeting without knowing the connection details.

**To configure Calendaring properties:**

- 1 Do one of the following:
  - In the local interface, go to **System > Admin Settings > Global Services > Calendaring Service** (select  if necessary).
  - In the web interface, go to **Admin Settings > Global Services > Calendaring Service**.
- 2 Configure these settings on the Calendaring Service screen:

Setting	Description
<b>Register with Calendaring Service</b>	Enables the system to connect to the Microsoft Exchange Server 2007 or 2010 or and retrieve calendar information.
<b>Microsoft Exchange Server Address</b>	Specifies the Fully Qualified Domain Name (FQDN) of the Microsoft Exchange Client Access Server. If your organization has multiple Client Access Servers behind a network load balancer, then this is the FQDN of the server's Virtual IP Address. If required, an IP address can be used instead of an FQDN, but Polycom recommends using the same FQDN that is used for Outlook clients.
<b>Domain</b>	Specifies the domain for registering to the Microsoft Exchange Server 2007 or 2010, in either NETBIOS or DNS notation, for example, either company.local or COMPANY.
<b>User Name</b>	Specifies the user name for registering to the Microsoft Exchange Server 2007 or 2010, with no domain information included. This can be the system's name or an individual's name.
<b>Password</b>	Specifies the system's password for registering with the Microsoft Exchange Server 2007 or 2010.



Setting	Description
<b>Mailbox (Primary SMTP)</b>	Specifies the Outlook mailbox this system should monitor for calendar information. This should match the Primary SMTP Address for the account in Microsoft Exchange Server 2007 or 2010, which is displayed as the value of the mail attribute in the account properties.
<b>Reminder Time in Minutes</b>	Specifies the number of minutes before the meeting to display a reminder.
<b>Play Reminder Tone</b>	Specifies whether to play a sound along with the text reminder when the system is not in a call.
<b>Show Private Meeting Information</b>	Specifies whether to display details about meetings marked private.

For information about displaying the Calendar button on the Home screen, refer to [Customizing the Home Screen](#) on page 7-3. For more information about using Polycom Conferencing for Microsoft Outlook, refer to the *User's Guide for Polycom HDX Systems*. For more information about setting up Microsoft Exchange Server 2007 or 2010 accounts to use the calendaring service, refer to the *Polycom Unified Communications Deployment Guide for Microsoft Environments* available on the Polycom website.



---

# System Location, Appearance, and Tones

## Configuring Regional Settings

You can configure regional settings for the Polycom HDX Systems and for Polycom Touch Control Devices. Refer to the following sections, [Configuring Polycom HDX Regional Settings](#), and [Configuring Polycom Touch Control Regional Settings](#) on page 7-2.

## Configuring Polycom HDX Regional Settings



In order to place ISDN and Analog Phone calls appropriately, leave **Always Dial Area Code** disabled if the country you call does not have area codes. Keep **Always Dial Area Code** enabled if you want to do 10 digit dialing.

### To configure the Polycom HDX regional settings:

- 1 To set the regional settings, do one of the following:
  - In the local interface, go to **System > Admin Settings > General Settings > Location** (select  if necessary).
  - In the web interface, go to **Admin Settings > General Settings > Date and Time**.

2 Configure these settings:

Setting	Description
<b>Country</b>	Specifies the country where the system is located. Changing the country automatically adjusts the country code associated with your system. <b>Note:</b> Changing this setting on a Polycom HDX 4000 series system causes the HDX system to restart.
<b>Language</b>	Sets the language for the user interface.
<b>International Dialing Prefix</b>	Specifies the international code required for placing ISDN calls from the system location to another country.
<b>Auto Adjust for Daylight Saving Time</b>	Specifies the daylight saving time setting. When you enable this setting, the system clock automatically changes for daylight saving time.
<b>Time Zone</b>	Specifies the time difference between GMT (Greenwich Mean Time) and your location.
<b>Time Server</b>	Specifies connection to a time server for automatic system time settings. The date and time must be manually reset every time a Polycom HDX 8000 series or Polycom HDX 7000 series system with Hardware Version A or Polycom HDX 4000 series system restarts, in the following cases: <ul style="list-style-type: none"> <li>• <b>Time Server</b> is set to <b>Off</b>.</li> <li>• <b>Time Server</b> is set to <b>Manual</b> or <b>Auto</b>, but the system cannot connect to a time server successfully.</li> </ul>
<b>Time Server Address</b>	Specifies the address of the time server to use when <b>Time Server</b> is set to <b>Manual</b> .
<b>Date Format and Time Format</b>	Specifies your format preference for the date and time display and lets you enter your local date and time.
<b>Display Time in Call</b>	Specifies the time display in a call: <ul style="list-style-type: none"> <li>• <b>Elapsed Time</b> – Displays the amount of time in the call.</li> <li>• <b>Local Time</b> – Displays the local time on the screen during a call.</li> <li>• <b>Off</b> – Time is not displayed.</li> </ul>

## Configuring Polycom Touch Control Regional Settings

To configure the Polycom Touch Control regional settings:

- 1 From the Home screen touch  **Administration**.
- 2 Touch the **Location** tab.

- 3 Select a language from the **Language** menu.
- 4 Configure the following settings under **Date and Time**:

Setting	Description
<b>Time Zone</b>	Specifies the time difference between GMT (Greenwich Mean Time) and your location.
<b>Time Server</b>	Specifies connection to a time server for automatic Touch Control time settings. The date and time must be manually reset every time the Touch Control restarts, in the following cases: <ul style="list-style-type: none"> <li>• <b>Time Server</b> is set to <b>Off</b>.</li> <li>• <b>Time Server</b> is set to <b>Manual</b> or <b>Auto</b>, but the Touch Control cannot connect to a time server successfully.</li> </ul>
<b>Time Server Address</b>	Specifies the address of the time server to use when <b>Time Server</b> is set to <b>Manual</b> .
<b>Time Format</b>	Specifies your format preference for the time display and lets you enter your local time.

## Customizing the Home Screen



With the exception of the Availability Control, Home screen customizations have no effect when the Polycom HDX system is paired with a Polycom Touch Control.

The home screen configuration lets you set up the system functionality according to your users' needs, skill levels, and environments. The following configurations show several ways you might want to set up the system.

### Infrequent Users (Kiosk Mode)

Provide a simple interface with a few specific items so that no training is needed:

- Provide access to pre-defined speed dial numbers.
- Use the marquee to add instructions on screen.
- Disable Allow Directory Changes and other Home screen items.



### New Users and Conference Rooms

Provide more options but keep it simple:

- Provide access to manual dialing on the Place a Call screen.
- Provide access to the directory, Recent Calls, and Favorites.



### Advanced Users

Provide additional options for advanced video conferencing users:

- Enable the System button for access to system settings, Diagnostics, and System Information.
- Access to Calendar to join scheduled meetings.
- Access to Favorites to place calls to frequently-called contacts.



Use the system's web interface to configure the buttons in the middle of the new Home screen.

#### To configure the Home screen buttons using the Polycom HDX web interface:

- 1 In your web browser address line, enter the HDX system's IP address.
- 2 Go to **Admin Settings > Home Screen Settings**.
- 3 Choose up to six of the following buttons to display in the center of the Home screen:
  - **Marquee:** You can configure Button 1 to be marquee text that scrolls across the top of the Home screen. In the field that appears next to the Marquee button selection, enter the text to display.
  - **Favorites:** You can configure any button to be a link to the Favorites list of contacts.
  - **Directory:** You can configure any button to be a link to the Directory screen.
  - **Place a Call:** You can configure any button to be a link to the Place a Call screen for manual dialing.

- **Recent Calls:** You can configure any button to be a link to the Recent Calls screen.
- **Calendar:** You can configure any button to be a link to the Calendar screen.
- **Speed Dial:** You can configure any or all of the buttons to place a call to a specific contact or group. Click the **Select Contact** button that appears next to the Speed Dial selection in the web interface to choose a contact or group from the directory for that button.

Enable the other items that you want to display on the Home screen such as system name, local time and date, System button, and Availability Control.



**Availability Control** must be enabled in the Home Screen settings in order for the Polycom Touch Control to display an Availability Control under User Settings.

### To design the home screen:

- 1 Do one of the following:
  - In the local interface, go to **System > Admin Settings > General Settings > Home Screen Settings** (select  if necessary).
  - In the web interface, go to **Admin Settings > General Settings > Home Screen Settings**.
- 2 Configure these settings on the Home Screen Settings screen:

Setting	Description
<b>System Name</b>	Specifies whether to display the name of the system on the Home screen. If this setting is disabled, “Home” is displayed.
<b>Local Date and Time</b>	Specifies whether to display the local date and time on the Home screen.
<b>System</b>	Allows users to access the System screen, which includes User Settings, Diagnostics, and System Information. If you remove the <b>System</b> button, you can still access the System screen by navigating to the Home screen, pressing  on the remote, and selecting <b>System</b> .
<b>My SIP, My IP, My Extension, My ISDN</b>	Specifies whether to display the system’s IP address, ISDN number, or both on the home screen.
<b>Availability Control</b>	Displays a control on the Home screen that allows users to set the system to <b>Available</b> or <b>Do Not Disturb</b> .

Setting	Description
<b>Last Number Dialed</b>	Specifies whether to display the last number dialed or clear the dialing field on the home screen.
<b>Call Quality</b>	Allows users to select the bandwidth for calls, as well as the call type, from the Place a Call screen. For information about enabling call types, refer to <a href="#">Configuring Call Preferences</a> on page 2-35.
<b>H.323 Extension (E.164)</b>	Allows users to enter H.323 extensions separately from the gateway ID on the Place a Call screen. If your system is registered with a gatekeeper, this setting also displays your H.323 extension on the home screen.  If you do not select this setting, users make gateway calls by entering the call information in this format: gateway ID + ## + extension

## Displaying Speed Dial Entries

You can display up to six speed dial entries on the Home screen, depending on whether you select other items to display on that screen.



### Points to note about speed dial entries:

- Up to six individual speed dial buttons replace the **Speed Dial** or **Sites** drop-down menu available in previous versions. If you need more than six speed dial entries, consider using Favorites. To place a call within your PBX system, enter the internal extension instead of the full number.
- Speed dial entries do not appear when the Polycom HDX system is paired with a Polycom Touch Control.

### To configure speed dial entries using the Polycom HDX web interface:

To configure speed dial entries, use the web interface.

- 1 In your web browser address line, enter the HDX system's IP address.
- 2 Go to **Admin Settings > Home Screen Settings**.
- 3 Select **Speed Dial** for any or all of the buttons.
- 4 Click the **Select Contact** button that appears next to the Speed Dial selection to choose a contact or group from the directory for that button.

## Adding Marquee Text

You can create marquee text to display in the dialing entry field on the home screen. You can create context-specific instructions for your users, or the marquee text can provide information that helps users choose which site to call.





Marquee text does not appear when the Polycom HDX system is paired with a Polycom Touch Control.

#### To enter marquee text using the Polycom HDX web interface:

- 1 In your web browser address line, enter the HDX system's IP address.
- 2 Enter the Admin ID and remote access password, if a password has been established.
- 3 Click **Admin Settings > General Settings > Home Screen Settings** and select **Marquee** for Button 1. In the field that appears next to the Marquee selection, type the text to display on the Home screen.

## Customizing Camera Names and Icons

Customizing the way cameras appear on screen helps users select the correct camera input during a call. You can enter camera names and assign icons. You can choose camera icons from categories including Corporate, Education, Justice, Manufacturing, and Medical.



#### To customize camera names and icons:

- 1 Do one of the following:
  - In the local interface, go to **System > Admin Settings > Cameras** (select  if necessary).
  - In the web interface, go to **Admin Settings > Cameras**.
- 2 For each camera or video source, enter a name and choose an icon.

## Screen Savers

For information about setting the Screen Saver Wait Time, refer to page 3-9. You can make changes to the screen saver only through the Polycom HDX web interface.

### Adding Screen Saver Text

You can customize the Polycom HDX system to display text when the system is in sleep mode. For instance, you can display on-screen instructions to assist users with what steps they should take next.



**Output upon Screen Saver Activation** on the Monitors screen must be set to **Black** if you want to display screen saver text.

#### To enter screen saver text using the Polycom HDX web interface:

- 1 In your web browser address line, enter the HDX system's IP address.
- 2 Enter the Admin ID and remote access password, if a password has been established.
- 3 Click **Utilities > Screen Saver** and enter:
  - **Screen Saver Text** – Appears as scrolling text when the system is in sleep mode. You can use this scrolling text to provide instructions or next steps for users of the system.
  - **Logo Screen Text** – Appears underneath the logo before the system goes into sleep mode.
- 4 Click **Update**.

### Adding a Screen Saver Logo

You can customize the Polycom HDX system to display your own logo instead of the Polycom logo.



When the Polycom HDX system is paired with a Polycom Touch Control, the screen saver logo displays on the Polycom HDX system's monitor but not the Polycom Touch Control screen.

**To upload a screen saver logo using the Polycom HDX web interface:**

- 1** In your web browser address line, enter the HDX system's IP address.
- 2** Enter the Admin ID and remote access password, if a password has been established.
- 3** Click **Utilities > Screen Saver**, click **Next**, and follow the onscreen instructions for uploading a logo file.



---

# Security

To configure your HDX system using the HDX web interface, you must use Internet Explorer version 6.x, 7.x, or 8.x and configure your browser to allow cookies. Enter the IP address of the HDX system using the `http://IPAddress` (for example, `http://10.11.12.13`) or `https://IPAddress` format. If you operate within a secure environment with the Maximum Security Profile or Security Mode enabled, you must use the `https://IPAddress` format. For more information about using the web interface, refer to [Accessing the Polycom HDX Web Interface](#) on page 9-1.



Use the HTTPS protocol to ensure that the configuration of all login information (such as user names and passwords) is transmitted using an encrypted channel, including those user names and passwords used to communicate with third-party systems on your network. Using HTTPS severely limits the ability of anyone on the network to discover these credentials.

## Screens that Require a Password for Access

You can configure Polycom HDX systems to provide two levels of access for people who are in the room with the system. You can require a user login to use the system. In addition, you can require an administrator login to configure system Admin Settings.



When you log in to use the system, you see a popup message showing the last successful login (in local time), the source of that login, and the number of unsuccessful login attempts to the HDX system that have been made from any source since the last login.

The following illustration shows which screens could require a user login and which screens could require an administrator login.

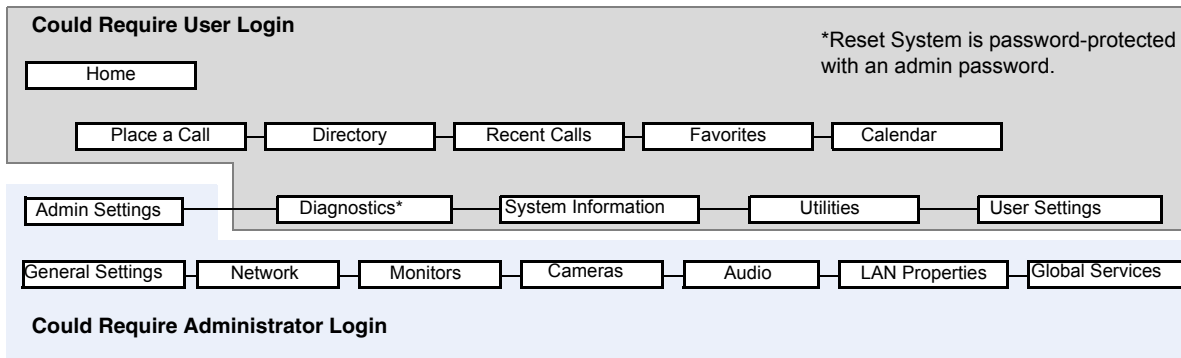

You can set an Admin Remote Access Password to restrict who can update the Polycom HDX system software or perform other remote management from a computer.

## Configuring Security Options

You can configure security options for Polycom HDX systems. To see the effect your choices have on the security settings, refer to the tables in the following sections:

- [Using the Maximum or High Security Profile](#) on page 8-11
- [Using the Medium Security Profile](#) on page 8-14
- [Using the Low Security Profile](#) on page 8-17
- [Using the Minimum Security Profile](#) on page 8-20

You can also configure an admin ID and password for the Polycom Touch Control. Refer to [Configuring Admin ID and Password for the Polycom Touch Control](#) on page 8-6 for more information.

## Configuring Security Options for Polycom HDX Systems

### To set passwords and security options:

- 1 Do one of the following:
  - In the local interface, go to **System > Admin Settings > General Settings > Security > Security Settings**. (select  if necessary).
  - In the web interface, go to **Admin Settings > General Settings > Security > Security Settings**.

## 2 Configure these settings on the Security screen:

Setting	Description
<b>Security Profile</b>	If set to <b>Maximum</b> , the Security Profile sets and controls particular security settings in order to meet very high security requirements, such as for government environments. The <b>Security Profile</b> setting can be changed only in the setup wizard.
<b>Security Mode</b>	Specifies whether the system uses Security Mode, which prevents unsecured access to the system. Every time you enable Security Mode, you must configure a new password for the system. The Security Mode setting is enabled by default for the <b>Maximum</b> and <b>High</b> security profiles and cannot be changed. The setting can be changed for <b>Medium</b> , <b>Low</b> , and <b>Minimum</b> security profiles.
<b>Use Room Password for Remote Access</b>	Specifies whether the room password used for local login is also used for the remote login.
<b>Meeting Password</b>	Specifies the password users must supply to join multipoint calls on this system if the call uses the internal multipoint option, rather than a bridge.  The meeting password cannot contain spaces or be more than 40 characters.  Do not set a meeting password if multipoint calls will include audio-only endpoints. Audio-only endpoints cannot participate in password-protected calls.  If there is a meeting password configured for a multipoint meeting hosted on a Polycom HDX system, Microsoft Office Communicator clients cannot join the meeting.
<b>Admin ID</b>	Specifies the ID for the administrator account. The default Admin ID is admin.  Admin IDs are not case sensitive.
<b>Admin Room Password</b>	Specifies the password for administrator access when logging in to the system locally.  When this password is set, you must enter it to configure the system Admin Settings using the remote control. The password cannot contain spaces or be more than 40 characters. Passwords are case sensitive.  The default Admin Room Password is the 14-digit system serial number from the <b>System Information</b> screen or the back of the system.  When the Polycom HDX system is paired with a Polycom Touch Control, you do not need to supply a room password.

Setting	Description
<b>Admin Remote Access Password</b>	<p>Specifies the password for administrator access when logging in to the system remotely using the web interface or a telnet session.</p> <p>When this password is set, you must enter it to update the software or manage the system from a computer. The password cannot contain spaces or more than 40 characters.</p>
<b>Require Login for System Access</b>	<p>Specifies whether the system automatically prompts users to log in when the system comes out of sleep mode. Enabling this setting requires a login to use the local interface.</p>
<b>User ID</b>	<p>Specifies the ID for the user account.</p> <p>User IDs are not case sensitive.</p>
<b>User Room Password</b>	<p>Specifies the password for user access when logging in to the system locally.</p> <p>When this password is set, you must enter it to access the system using the remote control. The password cannot contain spaces or more than 40 characters. Passwords are case sensitive.</p>
<b>User Remote Access Password</b>	<p>Specifies the password for user access when logging in to the system remotely. This setting is only available when Security Profile is set to <b>Maximum</b>.</p> <p>When this password is set, you must enter it to access the system from a computer. The password cannot contain spaces or more than 40 characters. Passwords are case sensitive.</p>
<b>Enable Remote Access</b>	<p>Specifies whether to allow remote access to the system by:</p> <ul style="list-style-type: none"> <li>• Web</li> <li>• Telnet</li> <li>• SNMP</li> </ul> <p>You may select any of these, or any combination of them.</p> <p><b>Note:</b> The system restarts if you change the remote access settings. This setting does not deactivate the associated port, only the application. Use <b>Web Access Port</b> to disable the port.</p> <p>When the Polycom HDX system is paired with a Polycom Touch Control, web remote access must be enabled.</p>



Setting	Description
<b>AES Encryption</b>	<p>Specifies how to encrypt calls with other sites that support AES encryption.</p> <ul style="list-style-type: none"> <li>• Off—AES Encryption is disabled.</li> <li>• When Available—AES Encryption is used with any endpoint that supports it, even if the other endpoints in the call don't support it.</li> <li>• Required for Video Calls Only—AES Encryption is used for all video endpoints in the call. Analog phone and voice over ISDN connections are allowed. Video endpoints must support AES Encryption to participate in the call.</li> <li>• Required for All Calls—AES Encryption is used for all video endpoints in the call. Analog phone and voice over ISDN connections are <i>not</i> allowed. All endpoints must support AES Encryption to participate in the call.</li> </ul>
<b>Web Access Port (http)</b>	<p>Specifies the port to use when accessing the system using the Polycom HDX web interface.</p> <p>If you change this from the default (port 80), specify a port number of 1025 or higher, and make sure the port is not already in use. You will need to include the port number with the IP address when you use the Polycom HDX web interface to access the system. This makes unauthorized access more difficult.</p> <p><b>Note:</b> The system restarts if you change the web access port.</p>
<b>Allow Video Display on Web</b>	<p>Specifies whether to allow viewing of the room where the system is located, or video of calls in which the system participates, using the Polycom HDX web interface.</p> <p><b>Note:</b> This feature activates both near site and far site video displays in Web Director.</p>
<b>Connect to my LAN</b>	<p>Specifies whether the system is part of the LAN.</p> <p>Changing this setting causes the system to restart.</p> <p>If <b>Connect to my LAN</b> is disabled, a Polycom HDX system cannot pair with a Polycom Touch Control.</p>
<b>Allow Access to User Settings</b>	<p>Specifies whether the User Settings screen is accessible to users via the System screen.</p> <p>Select this option if you want to allow users to change limited environmental settings. Refer to <a href="#">Enabling Secure Access</a> on page 8-8 for a description of how security profiles affect what users can change.</p>

Setting	Description
<b>NTLM Version</b>	Specifies the authentication protocol for use with Microsoft Office Communications Server or Microsoft Lync Server, LDAP directory, and Polycom Converged Management Application (CMA) or Polycom RealPresence Resource Manager system connections. If set to <b>Auto</b> , the system first tries NTLMv2, and if NTLMv2 fails it tries again with NTLMv1.
<b>Enable Sessions List</b>	Allows you to see a list of IP addresses that are logged in to your HDX system.
<b>Enable Security Banner</b>	<p>Specifies the security banner to display.</p> <ul style="list-style-type: none"> <li>• <b>Off</b> — Disables the security banner.</li> <li>• <b>Custom</b> — Allows you to enter text to use for the banner.</li> <li>• <b>DoD</b> — Specifies that the system displays a default U.S. Department of Defense security banner. You cannot view or change this text on the local interface, but you can change the text on the web interface.</li> </ul> <p>Banners can be displayed on the Login screen and the web's Security Banner window.</p> <p>The following is an example of banner text:</p> <p style="padding-left: 40px;">This machine is the property of Polycom, Inc., and its use is governed by company guidelines. You have NO right of privacy when using this machine.</p> <p><b>Note:</b> The security banner is not supported with the Polycom Touch Control.</p>
<b>Local System Banner Text</b>	<p>If you enable the security banner on the web interface, enter up to ten lines of text, each of which can contain up to 128 single-byte characters. The lines of text run together in paragraph format when they appear on the local system.</p> <p>If you enable the security banner on the local interface, the ten lines where you enter text are displayed below the <b>Enable Security Banner</b> field. The local interface does not have a <b>Local System Banner Text</b> field.</p> <p><b>Note:</b> The security banner is not supported with the Polycom Touch Control.</p>
<b>Remote Access Banner Text</b>	This field is visible only when you use the web interface. You can type or paste a maximum of 1,600 characters.

## Configuring Admin ID and Password for the Polycom Touch Control

You can set an Admin ID and password, which allows you to limit access to the Polycom Touch Control Administration settings.

**To set a Polycom Touch Control admin ID and password:**

- 1 From the Home screen touch  **Administration**.

An admin ID and password might be configured for the Touch Control Administration settings. The default ID is admin and the default password is 456.

- 2 Touch the **Security** tab.
- 3 Set the following security settings:

Setting	Description
<b>Admin ID</b>	Specifies the ID for the administrator account. The default Admin ID is admin.
<b>Admin Password</b>	Specifies the password for administrator access when logging in to the Touch Control. When this password is set, you must enter it to configure the Touch Control Admin Settings. The password must not contain spaces.

## Using the Sessions List

You can use the sessions list to see information about everyone logged in to an HDX system including:

- Type of connection, for example, Web
- User ID
- Remote IP address (that is, the addresses of people logged in to the HDX system from their computers)
- Session duration in hours, minutes, and seconds for each user currently logged into the HDX system
- How long the session has been idle, in seconds

When the sessions list is enabled, you can control how others access your system remotely. See [Managing Remote Access](#) on page 8-34 for more information using the sessions list for remote access.

**To enable the Sessions List:**

- >> Do one of the following:
- From the local interface, go to **System > Admin Settings > General Settings > Security > Security Settings** and set **Enable Sessions List** (select  if necessary).
  - From the web interface, go to **Admin Settings > General Settings > Security > Security Settings** and set **Enable Sessions List**.

**To view the Sessions List:**

>> Go to **System > Diagnostics > Sessions**.

- From the local interface, go to **System > Diagnostics > Sessions** (select  if necessary).
- From the web interface, go to **Diagnostics > Sessions**.

## Enabling Secure Access

### Using Security Profiles

The security profile your HDX system uses provides the basis for secure access within the system. The following five security profiles determine how users can operate the system.

Setting	Description
<b>Maximum</b>	Restricts most settings. With this profile, for example, some login settings are enabled with limited configurability to prevent security breaches. This profile is typically used for very high-level security, for example by some government agencies, and is the same as the former DoD/DSN setting.
<b>High</b>	Restricts certain settings, but some settings are changeable. This profile might be used by government agencies who need a high level of security but want more flexibility with how users work in the system.
<b>Medium</b>	Restricts some settings and allows for more user access to the system. Most settings are configurable. This profile might be useful for system administrators who have a moderate concern for security.
<b>Low</b>	Restricts very few settings. This profile might be useful for system administrators who want to require a password for remote access.
<b>Minimum</b>	Limitations are minimal. All settings are configurable. This profile might be useful for system administrators who need few restrictions within in their environment.

After the Polycom HDX system is up and running, you can change the Security Profile setting only by returning to the setup wizard. The setup wizard is available during initial setup, after a software update or system reset with system settings deleted, or after using the restore button.

**To view the configuration settings for your Security Profile:**

>> Do one of the following:

- In the local interface, go to **System > Admin Settings > General Settings > Security > Security Settings** (select  if necessary).
- In the web interface, go to **Admin Settings > General Settings > Security > Security Settings**.

## Configuring Security Mode

You can configure Polycom HDX systems to use Security Mode, which provides secure access to the system. Security Mode utilizes TLS, HTTPS, AES, digital signatures, and other security protocols, algorithms, and mechanisms to put the system into a secure mode. These protocols encrypt management communication over IP, preventing access by unauthorized users.

Every time you enable Security Mode, you must configure new passwords for the Admin, User, and Meeting passwords that are currently configured. The passwords cannot be blank and they cannot be the default value (the HDX system's serial number).

Security Mode requires secure access and a configured Admin password.



### Points to note about Security Mode:

- When you use the Maximum or High security profile, Security Mode is enabled by default and cannot be disabled. Security Mode is also enabled by default for the Medium security profile, but it can be disabled. Security Mode is disabled by default for the Low and Minimum security profiles, but can be enabled.
- Security profiles that require user logon or use the security banner are not supported when the Polycom HDX system is paired with a Polycom Touch Control.
- SNMP access is not available in Security Mode.
- Global Management System and *ReadiManager SE200* systems cannot monitor Polycom HDX systems in Security Mode.
- The web interface allows only HTTPS connections using TLS when Security Mode is enabled. Make sure that your web browser has TLS capabilities enabled.
- An Admin **Room** password is required (min length 1).
- **Telnet** remote access is disabled (read-only).
- **SNMP** remote access is disabled (read-only).
- The HTTP web access port is disabled (read-only).
- The HTTPS port is fixed at 443 (read-only).
- The Sessions list is enabled (read-only).
- Intrusion detection (NIDS) is enabled.

**To configure the system to use Security Mode:**

- 1 If you are using the HDX system with the Medium, Low, or Minimum security profile, do one of the following:
  - In the local interface, go to **System > Admin Settings > General Settings > Security > Security Settings**.
  - In the web interface, go to **Admin Settings > General Settings > Security > Security Settings**.

If you use the HDX system with the Maximum or High security profile, you can change the **Security Mode** setting only by going through the setup wizard.

- 2 Enable **Security Mode**.

When you change this setting, the Polycom HDX system restarts. Every time a Polycom HDX system is powered on or restarts in Security Mode, it verifies that the system software is authentic Polycom software.

**To access a Polycom HDX system in Security Mode using the Polycom HDX web interface:**

- 1 Enter the IP address of the system using secure HTTPS access, for example, `https://10.11.12.13`.
- 2 Click **Yes** in the security dialogs that appear. This access uses port 443.
- 3 To access Admin Settings using the Polycom HDX web interface when an Admin Remote Access Password is set, enter the Admin ID as the user name (default is `admin`).

## Security Selections

The default values and ability to change some HDX settings are affected by which security profile your system uses. The following tables illustrate how these settings are affected.

## Using the Maximum or High Security Profile

The following table shows the default values for specific Admin settings when you use the **Maximum** or **High** security profile. With the **Maximum** or **High** security profile, **Security Mode** is enabled and cannot be disabled.

Admin Settings Area/Setting	Maximum (was DoD/DSN)		High	
	Value	Configurable	Value	Configurable
<b>General Settings&gt;System Settings</b>				
Call Settings				
Auto Answer Point to Point Video	Disabled	Yes	Disabled	Yes
Auto Answer Multipoint Video	Disabled	Yes	Disabled	Yes
Call Detail Report	Enabled	Read Only	Enabled	Yes
<b>General Settings&gt;Home Screen Settings</b>				
Availability Control	Enabled	Read Only	Enabled	Read Only
Button (1-6): Recent Calls	Disabled	Read Only	Disabled	Yes
Place a Call/Last Number Dialed	Disabled	Read Only	Disabled	Yes
<b>General Settings&gt;Security&gt;Security Settings</b>				
Security Profile	Maximum	During Setup Only	High	During Setup Only
Security Mode	Enabled	Read Only	Enabled	Read Only
Use Room Password for Remote Access	Disabled	Read Only	Disabled	Yes
Require Login for System Access	Enabled	Read Only	Enabled	Yes
AES Encryption	Required- Video Calls	Yes	Required- Video Calls	Yes
Enable Remote Access: Web	Enabled	Yes	Enabled	Yes
Enable Remote Access: Web access port	443	Read Only	443	Read Only
Enable Remote Access: Telnet	Disabled	Read Only	Disabled	Read Only
Enable Remote Access: SNMP	Disabled	Read Only	Disabled	Read Only
Allow Video Display on Web	Disabled	Read Only	Disabled	Read Only
Enable Sessions List <b>Note:</b> Forced to "enabled" when External ADS Authentication is enabled.	Enabled	Read Only	Enabled	Read Only
<b>General Settings&gt;Security&gt;Password Settings</b>				
Admin Room, User Room, Remote Access, Meeting				
Reject Previous Passwords	10	8-16	10	Yes
Minimum Password Age in Days	1	1-30	Off	Yes
Maximum Password Age in Days	60	30-180	90	Yes
Password Expiration Warning in Days	7	1-7	4	Yes
Minimum Changed Characters	4	1-4	4	Yes

Admin Settings Area/Setting	Maximum (was DoD/DSN)		High	
	Value	Configurable	Value	Configurable
<b>Admin Remote Access</b>				
Minimum Length	15	8-15	6	Yes
Require Lowercase Letters	Off	Yes	Off	Yes
Require Uppercase Letters	Off	Yes	Off	Yes
Require Numbers	Off	Yes	Off	Yes
Require Special Characters	1	1-2	Off	Yes
Maximum Consecutive Repeated Characters	2	1-4	Off	Yes
Can Contain ID or Its Reverse Form	Disabled	Read Only	Disabled	Read Only
<b>Admin/User Room</b>				
Minimum Length	9	6-20	6	Yes
Require Lowercase Letters	Off	Yes	Off	Yes
Require Uppercase Letters	Off	Yes	Off	Yes
Require Numbers	Off	Yes	Off	Yes
Require Special Characters	Off	Yes	Off	Yes
Maximum Consecutive Repeated Characters	2	1-4	Off	Yes
Can Contain ID or Its Reverse Form	Disabled	Read Only	Disabled	Read Only
<b>Meeting</b>				
Minimum Length	Off	Off, 6-20	Off	Yes
Require Lowercase Letters	Off	Yes	Off	Yes
Require Uppercase Letters	Off	Yes	Off	Yes
Require Numbers	Off	Yes	Off	Yes
Require Special Characters	Off	Yes	Off	Yes
Minimum Changed Characters	Off	Off, 1-4	Off	Off, 1-4
Maximum Consecutive Repeated Characters	2	1-4	Off	Yes
<b>General Settings&gt;Security&gt;Security Banner</b>				
Enable Security Banner	DoD	Off not allowed	DoD	Yes
Remote Access Banner Text	DoD Banner Text	Yes	DoD Banner Text	Yes
<b>General Settings&gt;Security&gt;Certificates</b>				
Always Validate Peer Certificates from Browsers	Validate and Disconnect on Failure	Read Only	Validate and Disconnect on Failure	Yes
Always Validate Peer Certificates from Servers	Validate and Disconnect on Failure	Read Only	Validate and Disconnect on Failure	Yes



Admin Settings Area/Setting	Maximum (was DoD/DSN)		High	
	Value	Configurable	Value	Configurable
<b>General Settings&gt;Security&gt;Whitelist</b>				
Enable Whitelist	Enabled	Read Only	Enabled	Yes
<b>General Settings&gt;Security&gt;Account Management</b>				
Admin Account/Lock Account after Failed Logins	3	1-10	3	1-10
Admin Account/Account Lock Duration in Minutes	1	1-480	1	1-480
User Account/Lock Account after Failed Logins	3	1-10	3	1-10
User Account/Account Lock Duration in Minutes	1	1-480	1	1-480
Failed Login Window <b>Note:</b> Configurable only through the 'loginwindowduration' API command.	1	1-24	Off	1-24
<b>General Settings&gt;Security&gt;Remote Access Settings</b>				
Idle Session Timeout in Minutes	10	1-180	10	1-180
Maximum Number of Active Web Sessions	25	10-50	25	10-50
Max Number of Sessions Per User	3	1-5	3	1-5
Lock Port after Failed Logins	3	2-10	3	2-10
Port Lock Duration in Minutes	1	1-480	1	1-480
<b>General Settings&gt;Security&gt;External Authentication</b>				
Enable Active Directory Authentication	Enabled	Yes	Disabled	Yes
<b>General Settings&gt;Serial Port</b>				
RS-232 Mode	Off	Off or Control Only	Off	Off or Control Only
<b>Network&gt;IP Network</b>				
Enable SIP	Disabled	Read Only	Disabled	Yes
Transport Protocol	TLS	Read Only	TLS	Read Only
Enable Network Intrusion Detection System (NIDS) <b>Note:</b> Controlled only through the Security Mode setting's "Auto" option, which means this setting is enabled when Security Mode is enabled.	Auto (Enabled)	Read Only	Auto (Enabled)	Read Only
<b>Cameras</b>				
Far Control of Near Camera	Disabled	Yes	Disabled	Yes
<b>Global Services&gt;Directory Servers</b>				
XMPP <b>Note:</b> Controlled only through CMA or RealPresence Resource Manager system provisioning.	Disabled	Read Only	Disabled	Yes
LDAP	Disabled	Yes	Disabled	Yes
<b>Global Services&gt;Calendaring Service</b>				
Enable Calendaring Service	Disabled	Read Only	Disabled	Yes

### Other Restrictions when Using the Maximum Security Profile

- The **Recent Calls** feature is not available on the home screen of the local interface.
- **Polycom GDS** and **Microsoft Lync Server 2010** are not available in the **Directory Servers** settings.
- **SIP** is not available in the **IP Network** settings.

### Using the Medium Security Profile

The following table shows the default values for specific Admin settings when you use the **Medium** security profile. With the **Medium** security profile, **Security Mode** is enabled but can be disabled. Red text indicates a difference in a setting between operating with Security Mode on or off.

Admin Settings Area/Setting	Medium (Security Mode On)		Medium (Security Mode Off)	
	Value	Configurable	Value	Configurable
<b>General Settings&gt;System Settings</b>				
Call Settings				
Auto Answer Point to Point Video	Disabled	Yes	Disabled	Yes
Auto Answer Multipoint Video	Disabled	Yes	Disabled	Yes
Call Detail Report	Enabled	Yes	Enabled	Yes
<b>General Settings&gt;Home Screen Settings</b>				
Availability Control	Enabled	Yes	Enabled	Yes
Button (1-6): Recent Calls	Enabled	Yes	Enabled	Yes
Place a Call/Last Number Dialed	Disabled	Yes	Disabled	Yes
<b>General Settings&gt;Security&gt;Security Settings</b>				
Security Profile	Medium	During Setup Only	Medium	During Setup Only
Security Mode	<b>Enabled</b>	Yes	<b>Disabled</b>	Yes
Use Room Password for Remote Access	Enabled	Yes	Enabled	Yes
Require Login for System Access	Enabled	Yes	Enabled	Yes
AES Encryption	Required- Video Calls	Yes	Required- Video Calls	Yes
Enable Remote Access: Web	Enabled	Yes	Enabled	Yes
Enable Remote Access: Web access port	<b>443</b>	<b>Read Only</b>	<b>80</b>	<b>Yes</b>
Enable Remote Access: Telnet	Disabled	<b>Read Only</b>	Disabled	<b>Yes</b>
Enable Remote Access: SNMP	Disabled	<b>Read Only</b>	Disabled	<b>Yes</b>
Allow Video Display on Web	Disabled	Yes	Disabled	Yes

Admin Settings Area/Setting	Medium (Security Mode On)		Medium (Security Mode Off)	
	Value	Configurable	Value	Configurable
Enable Sessions List <b>Note:</b> Forced to "enabled" when External ADS Authentication is enabled.	Enabled	Yes	Enabled	Yes
<b>General Settings&gt;Security&gt;Password Settings</b>				
Admin Room, User Room, Remote Access, Meeting				
Reject Previous Passwords	Off	Yes	Off	Yes
Minimum Password Age in Days	Off	Yes	Off	Yes
Maximum Password Age in Days	Off	Yes	Off	Yes
Password Expiration Warning in Days	Off	Yes	Off	Yes
Minimum Changed Characters	Off	Yes	Off	Yes
Remote Access				
Minimum Length	3	<b>Yes (to a value greater than zero)</b>	3	<b>Yes (to any value)</b>
Require Lowercase Letters	Off	Yes	Off	Yes
Require Uppercase Letters	Off	Yes	Off	Yes
Require Numbers	Off	Yes	Off	Yes
Require Special Characters	Off	Yes	Off	Yes
Maximum Consecutive Repeated Characters	Off	Yes	Off	Yes
Can Contain ID or Its Reverse Form	Disabled	Yes	Disabled	Yes
Admin/User Room				
Minimum Length	3	<b>Yes (to a value greater than zero)</b>	3	<b>Yes (to any value)</b>
Require Lowercase Letters	Off	Yes	Off	Yes
Require Uppercase Letters	Off	Yes	Off	Yes
Require Numbers	Off	Yes	Off	Yes
Require Special Characters	Off	Yes	Off	Yes
Maximum Consecutive Repeated Characters	Off	Yes	Off	Yes
Can Contain ID or Its Reverse Form	Disabled	Yes	Disabled	Yes
Meeting				
Minimum Length	Off	Yes	Off	Yes
Require Lowercase Letters	Off	Yes	Off	Yes
Require Uppercase Letters	Off	Yes	Off	Yes
Require Numbers	Off	Yes	Off	Yes

Admin Settings Area/Setting	Medium (Security Mode On)		Medium (Security Mode Off)	
	Value	Configurable	Value	Configurable
Require Special Characters	Off	Yes	Off	Yes
Minimum Changed Characters	Off	Off, 1-4	Off	Off, 1-4
Maximum Consecutive Repeated Characters	Off	Yes	Off	Yes
<b>General Settings&gt;Security&gt;Security Banner</b>				
Enable Security Banner	Off	Yes	Off	Yes
Remote Access Banner Text	DoD Banner Text	Yes	DoD Banner Text	Yes
<b>General Settings&gt;Security&gt;Certificates</b>				
Always Validate Peer Certificates from Browsers	No Validation	Yes	No Validation	Yes
Always Validate Peer Certificates from Servers	No Validation	Yes	No Validation	Yes
<b>General Settings&gt;Security&gt;Whitelist</b>				
Enable Whitelist	Disabled	Yes	Disabled	Yes
<b>General Settings&gt;Security&gt;Account Management</b>				
Admin Account/Lock Account after Failed Logins	3	Off, 1-10	3	Off, 1-10
Admin Account/Account Lock Duration in Minutes	1	1-480	1	1-480
User Account/Lock Account after Failed Logins	3	Off, 1-10	3	Off, 1-10
User Account/Account Lock Duration in Minutes	1	1-480	1	1-480
Failed Login Window <b>Note:</b> Configurable only through the 'loginwindowduration' API command.	Off	1-24	Off	1-24
<b>General Settings&gt;Security&gt;Remote Access Settings</b>				
Idle Session Timeout in Minutes	10	1-180	10	1-180
Maximum Number of Active Web Sessions	25	10-50	25	10-50
Max Number of Sessions Per User	3	1-5	3	1-5
Lock Port after Failed Logins	3	Off, 2-10	3	Off, 2-10
Port Lock Duration in Minutes	1	1-480	1	1-480
<b>General Settings&gt;Security&gt;External Authentication</b>				
Enable Active Directory Authentication	Disabled	Yes	Disabled	Yes
<b>General Settings&gt;Serial Port</b>				
RS-232 Mode	Off	Yes	Off	Yes
<b>Network&gt;IP Network</b>				
Enable SIP	Disabled	Yes	Disabled	Yes
Transport Protocol	TLS	Yes	TLS	Yes
Enable Network Intrusion Detection System (NIDS) <b>Note:</b> Controlled only through the Security Mode setting's "Auto" option, which means this setting is enabled when Security Mode is enabled.	<b>Auto (Enabled)</b>	Read Only	<b>Auto (Disabled)</b>	Read Only

Admin Settings Area/Setting	Medium (Security Mode On)		Medium (Security Mode Off)	
	Value	Configurable	Value	Configurable
<b>Cameras</b>				
Far Control of Near Camera	Disabled	Yes	Disabled	Yes
<b>Global Services&gt;Directory Servers</b>				
XMPP <b>Note:</b> Controlled only through CMA or RealPresence Resource Manager system provisioning.	Disabled	Yes	Disabled	Yes
LDAP	Disabled	Yes	Disabled	Yes
<b>Global Services&gt;Calendaring Service</b>				
Enable Calendaring Service	Disabled	Yes	Disabled	Yes

### Using the Low Security Profile

The following table shows the default values for specific Admin settings when you use the **Low** security profile. With the **Low** security profile, **Security Mode** is enabled but can be disabled. Red text indicates a difference in a setting between operating with **Security Mode** on or off.

Admin Settings Area/Setting	Low (Security Mode On)		Low (Security Mode Off)	
	Value	Configurable	Value	Configurable
<b>General Settings&gt;System Settings</b>				
Call Settings				
Auto Answer Point to Point Video	Disabled	Yes	Disabled	Yes
Auto Answer Multipoint Video	Disabled	Yes	Disabled	Yes
Call Detail Report	Enabled	Yes	Enabled	Yes
<b>General Settings&gt;Home Screen Settings</b>				
Availability Control	Disabled	Yes	Disabled	Yes
Button (1-6): Recent Calls	Enabled	Yes	Enabled	Yes
Place a Call/Last Number Dialed	Disabled	Yes	Disabled	Yes
<b>General Settings&gt;Security&gt;Security Settings</b>				
Security Profile	Low	During Setup Only	Low	During Setup Only
Security Mode	<b>Enabled</b>	Yes	<b>Disabled</b>	Yes
Use Room Password for Remote Access	Enabled	Yes	Enabled	Yes
Require Login for System Access	Disabled	Yes	Disabled	Yes
AES Encryption	When Available	Yes	When Available	Yes
Enable Remote Access: Web	Enabled	Yes	Enabled	Yes

Admin Settings Area/Setting	Low (Security Mode On)		Low (Security Mode Off)	
	Value	Configurable	Value	Configurable
Enable Remote Access: Web access port	443	Read Only	80	Yes
Enable Remote Access: Telnet	Disabled	Read Only	Disabled	Yes
Enable Remote Access: SNMP	Disabled	Read Only	Disabled	Yes
Allow Video Display on Web	Disabled	Yes	Disabled	Yes
Enable Sessions List <b>Note:</b> Forced to "enabled" when External ADS Authentication is enabled.	Enabled	Yes	Enabled	Yes
<b>General Settings&gt;Security&gt;Password Settings</b>				
Admin Room, User Room, Remote Access, Meeting				
Reject Previous Passwords	Off	Yes	Off	Yes
Minimum Password Age in Days	Off	Yes	Off	Yes
Maximum Password Age in Days	Off	Yes	Off	Yes
Password Expiration Warning in Days	Off	Yes	Off	Yes
Minimum Changed Characters	Off	Yes	Off	Yes
Remote Access				
Minimum Length	1	Yes (to a value greater than zero)	Off	Yes (to any value)
Require Lowercase Letters	Off	Yes	Off	Yes
Require Uppercase Letters	Off	Yes	Off	Yes
Require Numbers	Off	Yes	Off	Yes
Require Special Characters	Off	Yes	Off	Yes
Maximum Consecutive Repeated Characters	Off	Yes	Off	Yes
Can Contain ID or Its Reverse Form	Disabled	Yes	Disabled	Yes
Admin/User Room				
Minimum Length	1	Yes (to a value greater than zero)	Off	Yes (to any value)
Require Lowercase Letters	Off	Yes	Off	Yes
Require Uppercase Letters	Off	Yes	Off	Yes
Require Numbers	Off	Yes	Off	Yes
Require Special Characters	Off	Yes	Off	Yes
Maximum Consecutive Repeated Characters	Off	Yes	Off	Yes

Admin Settings Area/Setting	Low (Security Mode On)		Low (Security Mode Off)	
	Value	Configurable	Value	Configurable
Can Contain ID or Its Reverse Form	Disabled	Yes	Disabled	Yes
<b>Meeting</b>				
Minimum Length	Off	Yes	Off	Yes
Require Lowercase Letters	Off	Yes	Off	Yes
Require Uppercase Letters	Off	Yes	Off	Yes
Require Numbers	Off	Yes	Off	Yes
Require Special Characters	Off	Yes	Off	Yes
Minimum Changed Characters	Off	Off, 1-4	Off	1-4
Maximum Consecutive Repeated Characters	Off	Yes	Off	Yes
<b>General Settings&gt;Security&gt;Security Banner</b>				
Enable Security Banner	Off	Yes	Off	Yes
Remote Access Banner Text	DoD Banner Text	Yes	DoD Banner Text	Yes
<b>General Settings&gt;Security&gt;Certificates</b>				
Always Validate Peer Certificates from Browsers	No validation	Yes	No validation	Yes
Always Validate Peer Certificates from Servers	No validation	Yes	No validation	Yes
<b>General Settings&gt;Security&gt;Whitelist</b>				
Enable Whitelist	Disabled	Yes	Disabled	Yes
<b>General Settings&gt;Security&gt;Account Management</b>				
Admin Account/Lock Account after Failed Logins	Off	Off, 1-10	Off	Off, 1-10
Admin Account/Account Lock Duration in Minutes	1	1-480	1	1-480
User Account/Lock Account after Failed Logins	Off	Off, 1-10	Off	Off, 1-10
User Account/Account Lock Duration in Minutes	1	1-480	1	1-480
Failed Login Window <b>Note:</b> Configurable only through the 'loginwindowduration' API command.	Off	1-24	Off	1-24
<b>General Settings&gt;Security&gt;Remote Access Settings</b>				
Idle Session Timeout in Minutes	Off	1-180	Off	1-180
Maximum Number of Active Web Sessions	25	10-50	25	10-50
Max Number of Sessions Per User	3	1-5	3	1-5
Lock Port after Failed Logins	Off	Off, 2-10	Off	Off, 2-10
Port Lock Duration in Minutes	1	1-480	1	1-480
<b>General Settings&gt;Security&gt;External Authentication</b>				
Enable Active Directory Authentication	Disabled	Yes	Disabled	Yes

Admin Settings Area/Setting	Low (Security Mode On)		Low (Security Mode Off)	
	Value	Configurable	Value	Configurable
<b>General Settings&gt;Serial Port</b>				
RS-232 Mode	Off	Yes	Off	Yes
<b>Network&gt;IP Network</b>				
Enable SIP	Disabled	Yes	Disabled	Yes
Transport Protocol	Auto	Yes	Auto	Yes
Enable Network Intrusion Detection System (NIDS) <b>Note:</b> Controlled only through the Security Mode setting's "Auto" option, which means this setting is enabled when Security Mode is enabled.	<b>Auto (Enabled)</b>	Read Only	<b>Auto (Disabled)</b>	Read Only
<b>Cameras</b>				
Far Control of Near Camera	Disabled	Yes	Disabled	Yes
<b>Global Services&gt;Directory Servers</b>				
XMPP <b>Note:</b> Controlled only through CMA or RealPresence Resource Manager system provisioning.	Disabled	Yes	Disabled	Yes
LDAP	Disabled	Yes	Disabled	Yes
<b>Global Services&gt;Calendaring Service</b>				
Enable Calendaring Service	Disabled	Yes	Disabled	Yes

## Using the Minimum Security Profile

The following table shows the default values for specific Admin settings when you use the **Minimum** security profile. With the **Minimum** security profile, **Security Mode** is enabled but can be disabled. Red text indicates a difference in a setting between operating with **Security Mode** on or off.

Admin Settings Area/Setting	Minimum (Security Mode On)		Minimum (Security Mode Off)	
	Value	Configurable	Value	Configurable
<b>General Settings&gt;System Settings</b>				
Call Settings				
Auto Answer Point to Point Video	Disabled	Yes	Disabled	Yes
Auto Answer Multipoint Video	Disabled	Yes	Disabled	Yes
Call Detail Report	Enabled	Yes	Enabled	Yes
<b>General Settings&gt;Home Screen Settings</b>				
Availability Control	Disabled	Yes	Disabled	Yes
Button (1-6): Recent Calls	Enabled	Yes	Enabled	Yes
Place a Call/Last Number Dialed	Enabled	Yes	Enabled	Yes



Admin Settings Area/Setting	Minimum (Security Mode On)		Minimum (Security Mode Off)	
	Value	Configurable	Value	Configurable
<b>General Settings&gt;Security&gt;Security Settings</b>				
Security Profile	Min	During Setup Only	Min	During Setup Only
Security Mode	<b>Enabled</b>	Yes	<b>Disabled</b>	Yes
Use Room Password for Remote Access	Enabled	Yes	Enabled	Yes
Require Login for System Access	Disabled	Yes	Disabled	Yes
AES Encryption	<b>Required-Video Calls</b>	Yes	<b>Off</b>	Yes
Enable Remote Access: Web	Enabled	Yes	Enabled	Yes
Enable Remote Access: Web access port	<b>443</b>	<b>Read Only</b>	<b>80</b>	<b>Yes</b>
Enable Remote Access: Telnet	<b>Disabled</b>	<b>Read Only</b>	<b>Enabled</b>	<b>Yes</b>
Enable Remote Access: SNMP	Disabled	<b>Read Only</b>	Disabled	<b>Yes</b>
Allow Video Display on Web	Disabled	Yes	Disabled	Yes
Enable Sessions List <b>Note:</b> Forced to "enabled" when External ADS Authentication is enabled.	Disabled	Yes	Disabled	Yes
<b>General Settings&gt;Security&gt;Password Settings</b>				
Admin Room, User Room, Remote Access, Meeting				
Reject Previous Passwords	Off	Yes	Off	Yes
Minimum Password Age in Days	Off	Yes	Off	Yes
Maximum Password Age in Days	Off	Yes	Off	Yes
Password Expiration Warning in Days	Off	Yes	Off	Yes
Minimum Changed Characters	Off	Yes	Off	Yes
Remote Access				
Minimum Length	<b>1</b>	<b>Yes (to a value greater than zero)</b>	<b>Off</b>	<b>Yes (to any value)</b>
Require Lowercase Letters	Off	Yes	Off	Yes
Require Uppercase Letters	Off	Yes	Off	Yes
Require Numbers	Off	Yes	Off	Yes
Require Special Characters	Off	Yes	Off	Yes
Maximum Consecutive Repeated Characters	Off	Yes	Off	Yes
Can Contain ID or Its Reverse Form	Enabled	Yes	Enabled	Yes

Admin Settings Area/Setting	Minimum (Security Mode On)		Minimum (Security Mode Off)	
	Value	Configurable	Value	Configurable
<b>Admin/User Room</b>				
Minimum Length	1	Yes (to a value greater than zero)	Off	Yes (to any value)
Require Lowercase Letters	Off	Yes	Off	Yes
Require Uppercase Letters	Off	Yes	Off	Yes
Require Numbers	Off	Yes	Off	Yes
Require Special Characters	Off	Yes	Off	Yes
Maximum Consecutive Repeated Characters	Off	Yes	Off	Yes
Can Contain ID or Its Reverse Form	Enabled	Yes	Enabled	Yes
<b>Meeting</b>				
Minimum Length	Off	Yes	Off	Yes
Require Lowercase Letters	Off	Yes	Off	Yes
Require Uppercase Letters	Off	Yes	Off	Yes
Require Numbers	Off	Yes	Off	Yes
Require Special Characters	Off	Yes	Off	Yes
Minimum Changed Characters	Off	Off, 1-4	Off	Off, 1-4
Maximum Consecutive Repeated Characters	Off	Yes	Off	Yes
<b>General Settings&gt;Security&gt;Security Banner</b>				
Enable Security Banner	Off	Yes	Off	Yes
Remote Access Banner Text	DoD Banner Text	Yes	DoD Banner Text	Yes
<b>General Settings&gt;Security&gt;Certificates</b>				
Always Validate Peer Certificates from Browsers	No validation	Yes	No validation	Yes
Always Validate Peer Certificates from Servers	No validation	Yes	No validation	Yes
<b>General Settings&gt;Security&gt;Whitelist</b>				
Enable Whitelist	Disabled	Yes	Disabled	Yes
<b>General Settings&gt;Security&gt;Account Management</b>				
Admin Account/Lock Account after Failed Logins	Off	Off, 1-10	Off	Off, 1-10
Admin Account/Account Lock Duration in Minutes	1	1-480	1	1-480
User Account/Lock Account after Failed Logins	Off	Off, 1-10	Off	Off, 1-10
User Account/Account Lock Duration in Minutes	1	1-480	1	1-480
Failed Login Window <b>Note:</b> Configurable only through the 'loginwindowduration' API command.	Off	1-24	Off	1-24

Admin Settings Area/Setting	Minimum (Security Mode On)		Minimum (Security Mode Off)	
	Value	Configurable	Value	Configurable
<b>General Settings&gt;Security&gt;Remote Access Settings</b>				
Idle Session Timeout in Minutes	10	1-180	10	1-180
Maximum Number of Active Web Sessions	25	10-50	25	10-50
Max Number of Sessions Per User	3	1-5	3	1-5
Lock Port after Failed Logins	Off	Off, 2-10	Off	Off, 2-10
Port Lock Duration in Minutes	1	1-480	1	1-480
<b>General Settings&gt;Security&gt;External Authentication</b>				
Enable Active Directory Authentication	Disabled	Yes	Disabled	Yes
<b>General Settings&gt;Serial Port</b>				
RS-232 Mode	Control(1) Vortex Mixer (2)	Yes	Control(1) Vortex Mixer (2)	Yes
<b>Network&gt;IP Network</b>				
Enable SIP	Enabled	Yes	Enabled	Yes
Transport Protocol	Auto	Yes	Auto	Yes
Enable Network Intrusion Detection System (NIDS) <b>Note:</b> Controlled only through the Security Mode setting's "Auto" option, which means this setting is enabled when Security Mode is enabled.	<b>Auto (Enabled)</b>	Read Only	<b>Auto (Disabled)</b>	Read Only
<b>Cameras</b>				
Far Control of Near Camera	Enabled	Yes	Enabled	Yes
<b>Global Services&gt;Directory Servers</b>				
XMPP <b>Note:</b> Controlled only through CMA or RealPresence Resource Manager system provisioning.	Disabled	Yes	Disabled	Yes
LDAP	Disabled	Yes	Disabled	Yes
<b>Global Services&gt;Calendaring Service</b>				
Enable Calendaring Service	Disabled	Yes	Disabled	Yes

## Enabling AES Encryption

AES encryption is a standard feature on all Polycom HDX systems. When it is enabled, the system automatically encrypts calls to other systems that have AES encryption enabled.

**To enable AES encryption:**

- 1 Do one of the following:
  - In the local interface, go to **System > Admin Settings > General > Security > Security Settings** (select  if necessary).
  - In the web interface, go to **Admin Settings > General > Security > Security Settings**.
- 2 **Enable AES Encryption.**

If encryption is enabled on the system, a locked padlock icon appears on the monitor when a call is encrypted. If a call is unencrypted, an unlocked padlock appears on the monitor. In a multipoint call, some connections might be encrypted while others are not. The padlock icon might not accurately indicate whether the call is encrypted if the call is cascaded or includes an audio-only endpoint. To avoid security risks, Polycom recommends that all participants communicate the state of their padlock icon verbally at the beginning of a call.

**Points to note about AES Encryption:**

- AES Encryption is not supported in Diagnostic Mode.
- AES Encryption is not supported on systems registered to an Avaya H.323 gatekeeper.
- For Polycom HDX systems with a maximum speed of 6 Mbps for unencrypted calls, the maximum speed for encrypted SIP calls is 4 Mbps. The maximum speed for encrypted calls with Security Mode enabled is also 4 Mbps.
- Polycom HDX systems negotiate AES-256 and AES-128 in H.323 and SIP calls with other HDX systems.

## Configuring Encryption Settings for Integration with Microsoft Office Communications Server 2007 R2 and Microsoft Lync Server 2010

Polycom HDX systems use the SRTP standard to support media encryptions in calls with Office Communicator. The encryption settings for each component also affect the ability to place encrypted calls.

Both the Microsoft Office Communications Server or Lync Server pool and the Polycom HDX system need to be configured to support encryption in order for calls to connect with encryption. If both components have encryption turned off, calls connect without encryption. If one component is set to require encryption and the other is not, calls fail to connect.

Calls from a Polycom HDX system to a Polycom RMX system using Microsoft Office Communications Server or Microsoft Lync Server require that the Polycom HDX system have encryption set to **When Available**

For more information about encryption configuration in a Microsoft Office Communications Server or Microsoft Lync Server environment, refer to the *Polycom Unified Communications Deployment Guide for Microsoft Environments*.

## Setting Password Policies

You can configure password policies for Admin, User, and Meeting passwords. These password settings can ensure that strong passwords are used.

### To configure password policies:

- Do one of the following:
  - In the local interface, go to **System > Admin Settings > General Settings > Security > Password Settings** (select  if necessary).
  - In the web interface, go to **Admin Settings > General Settings > Security > Password Settings**.
- Select **Admin Room Password**, **User Room Password**, **Meeting Password**, or **Remote Access Passwords**.



When **Use Room Password for Remote Access** is enabled, the room password policy is applied to both room and remote access passwords.

Changes to most password policy settings do not take effect until the next time the password is changed. Changes take effect immediately for Minimum Password Age in Days, Maximum Password Age in Days, and Password Expiration Warning in Days. Changing Minimum Length from Off to some other value also takes effect immediately.

- Configure these settings:

Setting	Description
<b>Minimum Length</b>	Specifies the minimum number of characters required for a valid password.
<b>Can Contain ID or Its Reverse Form</b>	Specifies whether the associated ID or the reverse of the ID can be part of a valid password. If this setting is enabled and the ID is admin, passwords admin and nimda are allowed.
<b>Require Lowercase Letters</b>	Specifies whether a valid password must contain one or more lowercase letters.
<b>Require Uppercase Letters</b>	Specifies whether a valid password must contain one or more uppercase letters.
<b>Require Numbers</b>	Specifies whether a valid password must contain one or more numbers.

Setting	Description
<b>Require Special Characters</b>	Specifies whether a valid password must contain one or more special characters. Supported characters include: @ - _ ! ; \$ , \ / & . # *
<b>Do Not Allow Previous Passwords</b>	Specifies the number of most recent passwords that cannot be reused. If set to <b>Off</b> , all previous passwords can be reused.
<b>Minimum Password Age in Days</b>	Specifies the minimum number of days that must pass before the password can be changed.
<b>Maximum Password Age in Days</b>	Specifies the maximum number of days that can pass before the password must be changed.
<b>Password Expiration Warning in Days</b>	Specifies how far in advance the system displays a warning that the password will soon expire, if a maximum password age is set.
<b>Minimum Changed Characters</b>	Specifies the number of characters that must be different or change position in a new password. If this is set to 3, "123abc" can change to "345cde" but not to "234bcd".
<b>Maximum Consecutive Repeated Characters</b>	Specifies the maximum number of consecutive repeated characters in a valid password. If this is set to 3, "aaa123" is a valid password but "aaaa123" is not.

## Setting the Room and Remote Access Passwords

You can set the Admin Room Password, Admin Remote Access Password, User Room Password, and User Remote Access Password to set various levels of access to the system using the remote control or keypad, or from a computer.

All passwords appear as a series of asterisks as you type them in a configuration or login screen. To enter numbers in a password field on the local interface, use the remote or keypad number buttons. To enter letters in a password field on the local interface, press  **Keyboard** on the remote or keypad.

### To use the same password for both local and remote access:

- Do one of the following:
  - In the local interface, go to **System > Admin Settings > General Settings > Security > Security Settings** (select  if necessary).
  - In the web interface, go to **Admin Settings > General Settings > Security > Security Settings**.
- Select **Use Room Password for Remote Access**.

**To reset a forgotten password:**

If you forget a Polycom HDX System Admin or User password, you must use the restore button to run the setup wizard again in order to access the Admin Settings and reset the password. For more information, refer to [Using the Restore Button on the Polycom HDX System](#) on page 12-2.

After the system restarts, it leads you through the setup wizard. You can enter new passwords when you set up the system.

If you forget a Polycom Touch Control Admin password, you must restore the device to its factory configuration. For more information, refer to [Performing a Factory Restore on the Polycom Touch Control](#) on page 12-5.

## Managing Certificates and Revocation

If your organization requires a secure environment, Polycom recommends that you have a strong understanding of certificate management before you implement these features.

Polycom HDX systems can generate and use certificates to authenticate network connections to and from the Polycom HDX system. Other web applications can also generate certificates, as you might notice when you navigate the Internet. The system uses configuration and management techniques typical of public-key infrastructure (PKI) to manage certificates, certificate signing requests (CSRs, sometimes also called unsigned certificates), and revocation lists. ANSI X.509 standards regulate the characteristics of certificates and revocation.

The certificate authority (CA) is the trusted entity that issues, or signs, digital certificates for others, as well as the certificates associated with the CA itself. You can manage certificates and revocation only through the Polycom HDX web interface.

Polycom encourages you to check your system logs daily to ensure that your installed certificates are current.

**To go to the web interface:**

- >> Open a web browser and enter the system's secure host name or IP address (for example, `https://10.11.12.13`). Click **Yes** in the security dialog boxes that appear.

## Working with Certificates

Certificates are authorized externally when they are signed by the CA. The certificates can be automatically validated when they are used to establish an authenticated network connection, that is, the certificate is validated when it is used.

If the HDX system generates a certificate, the certificate is authorized externally after the CA signs it. Certificates can be automatically validated when you use them to establish an authenticated network connection. Therefore, even if a certificate is authorized, it is not considered to be valid until you use it.

A certificate exchange is between a server and a client, both of which are peers. When you are using an HDX system, the HDX system is a web server and the web browser is the client application. In other situations, such as when the HDX system needs access to LDAP directory services or provisioning, the system is the client that communicates with the LDAP or provisioning server.

You must restart the HDX system for certificate and revocation changes to take effect.

**To configure certificate usage using the Polycom HDX web interface:**

- 1 Go to **Admin Settings > General Settings > Security > Certificates**.
- 2 Configure the following settings on the Certificates screen:

Setting	Description
<b>Maximum Peer Certificate Chain Depth</b>	Specifies how many links a certificate chain can have. The term <i>peer certificate</i> refers to any certificate sent by the far-end host to the HDX system when a network connection is being established between the two systems.
<b>Always Validate Peer Certificates from Servers</b>	Enables certificate validation by specifying whether the HDX system requires the server to present a valid certificate when the server makes secure connections for services such as provisioning, directory search, and session initiation protocol (SIP) calling. For some security profiles, this setting is always enabled.
<b>Always Validate Peer Certificates from Browsers</b>	Enables certificate validation by specifying whether the HDX system requires a browser to present a valid certificate when it tries to connect to the HDX web interface. For some security profiles, this setting is always enabled.

**To add a certificate on the Certificates screen:**

- 1 Click **Browse** to search for and select a certificate.
- 2 Click **Add**.

The system checks the certificate data and adds it to the list. If you don't see the certificate in the list, the system was unable to recognize the certificate. This process is sometimes referred to as *installing* a certificate.



You can select a certificate in the list to view its contents. You can also remove a certificate from the list by clicking **Remove**.

When you add a CA certificate to the HDX system, the certificate becomes trusted for the purpose of validating peer certificates.



If you do not add the certificates for the HDX system before using the HDX web interface, you might receive error messages from your browser stating that the security certificate for the web site "Polycom" cannot be verified.

## Using Certificate Signing Requests (CSRs)

The HDX system allows you to install one client and one server certificate for identification of the HDX system to network peers. Whether you need these client-type or server-type identity certificates depends on which HDX features and services you intend to use, and whether your network environment supports certificate-based authentication for those services.

For example, if your HDX system is configured to use the following features, you might need to create a client-type CSR and add the resulting certificate approved by the CA:

- Provisioning
- CMA or RealPresence Resource Manager System Monitoring
- Directory
- Presence
- Calendaring
- SIP
- 802.1X

Only the HDX web server uses the server-type CSR and resulting certificate. That is, the server certificate does not validate the client identity on the HDX system, but it does identify the HDX system to the browser. You need the server certificate if, as the browser user, you want to be certain about the identity of the HDX system you're connecting to. Settings in the web browser typically validate the server certificate, but you can also validate the certificate manually.

The following applications are either disabled in Security Mode, or do not use digital certificates:

- Telnet
- H.323
- Global Management System™

If your HDX system uses features that require certificates and does not have the certificates installed, you must first create a CSR. You can create one client and one server CSR and submit each to the appropriate CA for signing. After the CSR is signed by a CA, it becomes a certificate you can add to the HDX system. If you create additional client or server CSRs on the HDX system, they replace the existing CSR of the same type.



When creating client and server CSRs, one type of CSR overwrites the other if the information in the editable fields of both CSRs is identical. Be sure to change at least one character in any of the editable fields.

**To create a CSR on the Polycom HDX web interface:**

- 1 Go to **Admin Settings > General Settings > Security > Certificates**.
- 2 Click **Create** for the type of CSR you want to create. The procedure is the same for server and client CSRs.
- 3 Configure the following settings on the Create Certificate Signing Request (CSR) screen:

Setting	Description
<b>Type</b>	Creates either a Client or Server CSR.
<b>Hash Algorithm</b>	Specifies the hash algorithm for the CSR. You may select SHA-256 or keep the default SHA-1.
<b>Common Name (CN)</b>	Specifies the name that the system assigns to the CSR.
<b>Organizational Unit (OU)</b>	Specifies the unit of business defined by your organization.
<b>Organization (O)</b>	Specifies your organization's name.
<b>City or Locality (L)</b>	Specifies the city where your organization is located.
<b>State or Province (ST)</b>	Specifies the state or province where your organization is located.
<b>Country (C)</b>	Displays the country selected in <b>Admin Settings &gt; General Settings &gt; Location</b> .



The HDX system supports only one OU field. If you want the signed certificate to include more than one OU field, you must download and edit the CSR manually.

## Verifying Certificate Validity

When certificate validation is enabled (refer to page 8-28), the HDX system tries to validate the peer certificate chain on secure connection attempts for the applicable network services.

The **Always Validate Peer Certificates from Browsers** setting controls how the HDX web server behaves. Enabling this setting has an effect only if Security Mode is also enabled on the HDX system, because if Security Mode is

not enabled, browsers can connect to the HDX web server through an unsecured IP address. If you don't use a secure address (HTTPS), certificates are not exchanged. With validation enabled, the HDX web server rejects connection attempts from browsers that don't present a valid certificate.

The **Always Validate Peer Certificates from Servers** setting controls how all of the other SSL-enabled applications on HDX system, such as LDAP or provisioning behave. When this setting is enabled, these applications attempt to validate the server certificate when they connect via SSL/TLS to a server. The connection will be rejected if the server does not present a valid certificate.

Validation might fail for other reasons, such as certificate expiration or revocation. The HDX system can check revocation status by using certificate revocation lists (CRLs) or the online certificate status protocol (OCSP). A CRL is a list of certificates that have been revoked by the CA. An OCSP responder is a network server that provides real-time certificate status through a query/response message exchange.

Configure the HDX system to use the same method that is used by the CA. You must get CRL data files from the CA.



If you use OCSP, you might need to install one or more additional CA certificates on the HDX system, for validation of the OCSP response messages.

The Polycom HDX system supports HTTP-based OCSP transactions.

### To add CRLs on the Polycom HDX web interface:

- 1 Go to **Admin Settings > General Settings > Security > Revocation**.
- 2 Configure the following settings on the Revocation screen:

Setting	Description
<b>Revocation Method</b>	Specifies whether to use CRL or OSCP for revocation.
<b>Allow Incomplete Revocation Checks</b>	When this field is enabled, specifies whether a certificate in the chain is verified without a revocation status check if no corresponding CRL is installed.  The HDX system assumes that the lack of a CRL means the certificate is not revoked. If all required CRLs are installed, the system performs revocation checks when validating the certificate.
<b>Add a Certificate Revocation List (CRL)</b>	<ol style="list-style-type: none"> <li>1 Click <b>Browse</b> to search for and select a CRL.</li> <li>2 Click <b>Add</b> to add the CRL to the list.</li> </ol>

You can also remove a CRL from the list by clicking **Remove**.

**To configure OCSP on the Polycom HDX web interface:**

- 1 Go to **Admin Settings > General Settings > Security > Revocation**.
- 2 Configure the following settings on the Revocation screen:

Setting	Description
<b>Revocation Method</b>	Specifies whether to use CRL or OSCP for revocation.
<b>Allow Incomplete Revocation Checks</b>	<p>When this field is enabled, the HDX system requests the revocation status from the OSCP responder.</p> <ul style="list-style-type: none"> <li>• If the OSCP responds that the status is <i>unknown</i> or if no response is received for any certificate in the chain, the system continues checking and accepts the connection if no other validation errors occur.</li> <li>• If the OSCP responder indicates a known <i>revoked</i> status, the HDX system does not allow the connection.</li> <li>• If the OSCP responder indicates a known <i>good</i> status, the HDX system allows the connection.</li> </ul>
<b>Global Responder Address</b>	Specifies the URI of the responder that services OSCP requests (for example, <code>http://responder.example.com/ocsp</code> ). This responder is used for all OSCP validation
<b>Use Responder Specified in Certificate</b>	In some cases, the certificate itself includes the responder address. When this field is enabled, the HDX system uses the address in the certificate (when present) instead of the <b>Global Responder Address</b> specified in the previous field.

## Deleting Certificates and CRLs

In some cases, expired certificates or CRLs might prevent you from accessing the web interface. You can use the local interface to reset your system without certificates, to restore access to the web interface.

**To delete all certificates and CRLs the HDX system is using:**

- 1 In the local interface, go to **System > Diagnostics > Reset System**.
- 2 Enter your system's **Serial Number**.
- 3 Enable the **Delete Certificates** field.
- 4 Select **Reset System**.

The HDX system restarts after deleting all installed certificates and CRLs.

## Enabling a Whitelist

When a whitelist is enabled, the Polycom HDX system allows access to its web interface only by those systems with an IP address that matches a pattern using regular expression notation that is specified by this setting. You can use this feature only through the web interface.

With regular expression notation, addresses are matched by pattern, which means that you must take care to form your regular expressions to allow only systems you mean to allow. In particular, regular expression notation treats the period (.) character as a single wildcard (\*) character. This results in interpreting what looks like a normal IP address as a wildcard expression. For example, if you entered an IP address of 15.1.2.111, all of the following results would match:

- 15.1.2.111
- 15.182.111
- 15.152.111

In order to prevent the wildcard treatment of the period (.) character, you must use a backslash (\) character immediately preceding the period (.) character. This escapes the period (.) character so that it is treated as a period. Using this mechanism, the IP address 15.1.2.111 is correctly represented in regular expression notation as 15\.1\.2\.111.

If you want to allow a range of IP addresses, use the wildcard (\*). The following examples use the wildcard (\*) to allow a range of IP addresses:

- Enter 10\.11\.\*\.\* to allow all IP addresses that begin with 10.11.
- To allow the IP address 1.2.3.4, any address in the 10.11.\*.\* subnet and any address in the 20.10.1x.\* subnet, enter:
  - 1\.2\.3\.4
  - 10\.11\.\*\.\*
  - 20\.10\.1\.\*

### To use a whitelist on the Polycom HDX web interface:

- 1** Go to **Admin Settings > General Settings > Security > Whitelist**.
- 2** Select **Enable Whitelist**.
- 3** In the **Add IP Address** field, use regular expression notation to enter the IP address of the system you want to allow, then click **Add**.

Repeat this step for all the IP addresses you want to add.

If you entered an address in error, you can highlight it in the list and click **Remove**.

## Managing Remote Access

*Remote access* means using a Polycom HDX system in some way other than through the local interface, such as by using the web, a serial port, or telnet. Refer to [Using the Sessions List](#) on page 8-7 for information about the sessions mentioned in the table and enabling the sessions list.

### To configure remote access settings:

- 1 Do one of the following:
  - In the local interface, go to **System > Admin Settings > General Settings > Security > Remote Access Settings** (select  if necessary).
  - In the web interface, go to **Admin Settings > General Settings > Security > Remote Access Settings**.
- 2 Configure the following settings:

Setting	Description
<b>Idle Session Timeout in Minutes</b>	When sessions are enabled, specifies the number of minutes your system can be idle before the session times out. Select 1 to 480 minutes.
<b>Maximum Number of Active Web Sessions</b>	When sessions are enabled, specifies the number of users who can be logged in to your system at the same time. Enter a value between 10 and 50.
<b>Maximum Number of Sessions Per User</b>	When sessions are enabled, specifies the maximum number of active sessions one user can have at a time.

The **Lock Port after Failed Logins** and **Port Lock Duration in Minutes** fields are discussed in [Port Lockout](#) on page 8-38.

## Enabling External Authentication

Polycom HDX systems support two roles for accessing the system, an admin role and a user role. Admins can perform administrator activities such as changing configuration, as well as user activities such as placing and answering calls. Users can perform only user-type activities.



When the Polycom HDX system is paired with a Polycom Touch Control, only the local Polycom HDX system admin credentials can be used to pair with the HDX system.

Polycom HDX systems provide two local accounts, one for the user role (by default named **user**) and one with for the admin role (by default named **admin**). The IDs and passwords for these local accounts are stored on the HDX system itself.

An administrator can also configure HDX systems to grant access using network accounts that are authenticated through an Active Directory (AD) server. In this case, the account information is stored on the AD server and not on the HDX system. The AD administrator assigns accounts to AD groups, one for HDX system admin access and one for user access.

The HDX system administrator configures the external authentication settings on the HDX system to specify the AD group for user access and the AD group for admin access on the HDX system. The HDX system can map only one Active Directory group to a given role. After the HDX system administrator selects **Enable Active Directory Authentication** and **Require Login for System Access**, users must enter their network name and password when the local HDX system interface prompts them to log in. Admins can enter either their local or network login information.

Software version 3.0 supports Active Directory on Microsoft Windows Server version 2003 and Microsoft Windows Server 2008.



The HDX system user account is disabled when **Enable Active Directory Authentication** and **Require Login for System Access** are enabled.

#### To enable external authentication:

- 1 Do one of the following:
  - In the local interface, go to **System > Admin Settings > General Settings > Security > External Authentication** (select  if necessary).
  - In the web interface, go to **Admin Settings > General Settings > Security > External Authentication**.
- 2 Configure the following settings on the External Authentication screen:

Setting	Description
<b>Enable Active Directory Authentication</b>	Specifies whether to authenticate users through the Active Directory server. When Active Directory authentication is enabled, login is required to access the <b>Admin Settings</b> on the HDX system.
<b>Active Directory Server Address</b>	Specifies the DNS or IP address of the Active Directory server.

Setting	Description
<b>Active Directory Admin Group</b>	Specifies the Active Directory group whose members should have access to the Admin settings on the HDX system. This name must exactly match the name in the Active Directory server for authentication to succeed.
<b>Active Directory User Group</b>	Specifies the Active Directory group whose members should have access to the User settings on the HDX system. This name must exactly match the name in the Active Directory server for authentication to succeed.



If external authentication is not active after completing these steps, go to **Admin Settings > LAN Properties** and ensure that the **Domain Name** setting contains the name of your Active Directory domain.

## Setting Account and Port Lockouts

HDX systems provide access controls that prevent unauthorized use of the system. One way someone might try to discover valid user names and passwords is by exhaustively attempting to log in, varying the user name and password data in a programmatic way until discovering a combination that succeeds. Such a method is called a “brute-force” attack.

To mitigate the risk of such an attack, two access control mechanisms are available on HDX systems. The first type of access control, Account Lockout, is used in conjunction with external authentication, while the second, Port Lockout, is used when external authentication is not active. Refer to [Enabling External Authentication](#) on page 8-34 for more information.

### Account Lockout

Account Lockout temporarily locks an account from accepting logins after a configurable number of unsuccessful attempts to log in to that account. It is available only when external authentication is enabled, but protects only the local HDX system's Admin and User local accounts. The Active Directory Server protects Active Directory accounts.

HDX systems provide separate account lockout controls for each of their local accounts, which are named **Admin** and **User**. The account lock can be invoked due to failed logins on any of the following login ports:

- Local interface
- Web interface



- Serial port configured with an **RS-232 Mode** setting of **Control**, only when the HDX system is using the Maximum Security Profile
- Polycom Touch Control pairing

### To configure the account lockout feature:

- 1 Do one of the following:
  - In the local interface, go to **System > Admin Settings > General Settings > Security > Account Management** (select  if necessary).
  - In the web interface, go to **Admin Settings > General Settings > Security > Account Management**.
- 2 Select **Admin Account** or **User Account**.
- 3 Configure these settings on the Admin Account or User Account screen:

Setting	Description
<b>Lock Account after Failed Logins</b>	Specifies the number of failed login attempts allowed before the system locks the account. If set to <b>Off</b> , the system does not lock the user account due to failed login attempts.
<b>Account Lock Duration in Minutes</b>	Specifies the amount of time that the account remains locked due to failed login attempts.

The following is an example of how the account lockout feature works.

An HDX system is configured with these settings:

- **System > Admin Settings > General Settings > Security > External Authentication** is enabled.
- **System > Admin Settings > General Settings > Security > Account Management > Lock Account after Failed Logins** is set to **4**.

A user fails to log in to the **Admin** account twice on the web interface, and the same or another user fails to log in to the **Admin** account on the local interface. This means that three failed attempts have been made to the **Admin** account so far. If the next attempt to log in to the **Admin** account on any login port is unsuccessful, which would mean four failed logins, further attempts to access the **Admin** account are locked out until the expiration of the **Account Lock Duration in Minutes** period has elapsed. As this example illustrates, the failed login attempts made to an account accumulate across any login port.

## Port Lockout

Port Lockout protects against brute-force attacks by temporarily locking the login port after a configurable number of unsuccessful login attempts have been made, regardless of which account was used. This feature is available on all login ports when **External Authentication** is disabled and always on either of the following ports:

- Any serial port that uses **Control** for its **RS-232 Mode** setting when the system is also configured in the Maximum Security Profile. For more information about the **RS-232 Mode** setting, refer to [Configuring RS-232 Serial Port Settings](#) on page 10-5.
- The Polycom Touch Control pairing port.

Specifically, Port Lockout on the HDX system protects logins on the following login ports:

- Local interface, when **Require Login for System Access** is enabled. For more information about security settings, refer to [Configuring Security Options](#) on page 8-2.
- Web interface
- Serial port configured with an **RS-232 Mode** setting of **Control**, only when the HDX system is using the Maximum Security Profile
- Polycom Touch Control pairing

HDX systems provide one set of port lock configuration settings for the local interface and Polycom Touch Control, and another set for port lockout on the other ports.

### To configure the port lockout feature for the local interface and Polycom Touch Control:

- 1 Do one of the following:
  - In the local interface, go to **System > Admin Settings > General Settings > Security > Account Management** (select  if necessary).
  - In the web interface, go to **Admin Settings > General Settings > Security > Account Management**.
- 2 Select the **Admin Account** and configure these settings:

Setting	Description
<b>Lock Account after Failed Logins</b>	Specifies the number of failed login attempts allowed before the system locks the local interface from accepting logins. If set to <b>Off</b> , the system will not lock the local interface due to failed login attempts.
<b>Account Lock Duration in Minutes</b>	Specifies the amount of time that the local interface remains locked due to failed login attempts.

**To configure the port lockout feature for the web interface and any serial ports configured with the Control setting:**

- 1 Do one of the following:
  - In the local interface, go to **System > Admin Settings > General Settings > Security > Remote Access Settings** (select  if necessary).
  - In the web interface, go to **Admin Settings > General Settings > Security > Remote Access Settings**.
- 2 Configure these settings:

Setting	Description
<b>Lock Port after Failed Logins</b>	Specifies the number of failed login attempts allowed before the system locks a remote access login port from accepting logins. If set to <b>Off</b> , the system does not lock remote access login ports due to failed login attempts.
<b>Port Lock Duration in Minutes</b>	Specifies the amount of time that a remote access login port remains locked due to failed login attempts.

The following is an example of how the port lockout feature works.

An HDX system is configured with these settings:

- **System > Admin Settings > General Settings > Security > External Authentication** is disabled.
- **System > Admin Settings > General Settings > Security > Security Settings > Require Login for System Access** is enabled.
- **System > Admin Settings > General Settings > Security > Remote Access Settings > Lock Port after Failed Logins** is set to **3**.
- **System > Admin Settings > General Settings > Security > Account Management > Admin Account > Lock Account after Failed Logins** is set to **5**.

A user fails to log in to the **Admin** account twice on the web interface, and at the same time another user has also failed twice to log in to the **Admin** account on the local interface. If the next attempt to log in to the **Admin** account on the web interface is unsuccessful, the web interface is locked to further logins until the expiration of the **Port Lock Duration in Minutes** period. However, the user on the local interface still has three more attempts to successfully login before the local interface locks. As this example illustrates, the failed login attempts made to a port are specific to that port and do not accumulate across other login ports. Each port has its own counter.

## Managing User Access to Settings and Features

You can allow users to change common user preferences by providing access to the User Settings screen.

### To allow users to customize the workspace:

- 1 Do one of the following:
  - In the local interface, go to **System > Admin Settings > General Settings > Security > Security Settings** (select  if necessary).
  - In the web interface, go to **System > Admin Settings > General Settings > Security > Security Settings**.
- 2 Select the **Allow Access to User Settings** option to make the **User Settings** button available to users on the **System** screen.

If the Polycom HDX system is paired with a Polycom Touch Control, selecting **Allow Access to User Settings** makes the **HDX System** tab available on the Touch Control User Settings screen.

User Settings contains the following options, which are also available to administrators under Admin Settings:

- Meeting Password
- Backlight Compensation
- Mute Auto-Answer Calls
- Far Control of Near Camera
- Auto Answer Point-to-Point or Multipoint Video
- PIP (not available on the Polycom HDX 4000 series or Polycom Touch Control)
- Keypad Audio Confirmation (not available on the Polycom Touch Control)
- Far Site Name Display Time (not available on the Polycom Touch Control)
- Dual Monitor Emulation (not available on the Polycom Touch Control)
- Allow Video Display on Web

## Setting up Log Management

You can manage Polycom HDX system log files from the system's web or local interface. Refer to [Setting up Polycom HDX Log Management](#) below for more information.

You can also manage Polycom Touch Control log files from the Touch Control interface. Refer to [Managing Polycom Touch Control Logs](#) on page 8-43 for more information.

### Setting up Polycom HDX Log Management

The Polycom HDX system log files consist of the following information:

- System logs
- Call Detail Report (CDR)
- Configuration profile

You can transfer the log to an external USB storage device manually, or automatically based on a configurable percent-filled threshold. To manually transfer logs, you must use the Polycom HDX local interface.

If the Polycom HDX system is paired with a Polycom Touch Control, you must power off the Touch Control before transferring logs from the Polycom HDX system using an external USB storage device. Refer to [Powering On the Polycom Touch Control Device](#) on page 1-14 for more information.

When the log fills up past the threshold, the following actions are triggered:

- Transfers the log to the USB device if Transfer Frequency is set to "Auto at Threshold"
- Creates a log entry indicating that the threshold has been reached
- Displays an alert on the home screen
- Displays an indicator on the System Status screen

To view the log file status, go to **System > Diagnostics > System Status**.

Highlight **Log Threshold** and press  **Info** on the remote or keypad, or go to **Diagnostics > System Status** and select **Log Threshold**.



When the Log Threshold indicator is yellow or red, automatic log transfers cannot be completed, and data may be lost.

**To configure Polycom HDX log management:**

- 1 Do one of the following:
  - In the local interface, go to **System > Admin Settings > General Settings > Security > Log Management** (select  if necessary).
  - In the web interface, go to **Admin Settings > General Settings > Security > Log Management**.
- 2 Configure these settings on the Log Management screen:

Setting	Description
<b>Current Percent Filled</b>	Displays how full the log file is, as a percentage of the total size.
<b>Percent Filled Threshold</b>	Specifies a threshold for the percent filled value. Reaching the threshold triggers an alarm, creates a log entry, and transfers the log if <b>Transfer Frequency</b> is set to <b>Auto at Threshold</b> . <b>Off</b> disables logging threshold notifications.
<b>Folder Name</b>	Specifies the name to give the folder for log transfers. <ul style="list-style-type: none"> <li>• <b>System Name and Timestamp</b> — Folder name is the system name and the timestamp of the log transfer, in the date and time format specified on the Location screen. For example, if the system name is “Marketing”, the folder name could be marketing_MMddyyymmssSSS.</li> <li>• <b>Timestamp</b> — Folder name is the timestamp of the log transfer, in the date and time format specified on the Location screen, for example yyyyMMddhhmmssSSS.</li> <li>• <b>Custom</b> — Optional folder name for manual log transfers.</li> </ul>
<b>Storage Type</b>	Specifies the type of storage device used for log file transfers.
<b>Transfer Frequency</b>	Specifies when the logs are transferred: <ul style="list-style-type: none"> <li>• <b>Manual</b> — The transfer starts when you select the <b>Start Log Transfer</b> button, which is visible only on the local interface. If the log fills before being transferred, new events overwrite the oldest events.</li> <li>• <b>Auto at Threshold</b> — The transfer starts automatically when the Percent Filled Threshold is reached.</li> </ul>

**To transfer the Polycom HDX log manually:**

- 1 In the local interface, go to **System > Admin Settings > General Settings > Security > Log Management**.
- 2 Specify a folder name.

- 3 Click **Start Log Transfer**.

If the specified folder name already exists, the system prompts you to specify a new folder name.

- 4 Wait until the system displays a message that the log transfer has completed successfully before you remove the storage device.

## Managing Polycom Touch Control Logs

You can transfer the Touch Control logs to an external USB storage device.

### To transfer Polycom Touch Control logs:

- 1 Ensure that a USB device is connected to the USB port on the right side of the Polycom Touch Control.

- 2 From the Home screen touch  **Administration**.

An admin ID and password might be configured for the Touch Control Administration settings. The default ID is `admin` and the default password is `456`.

- 3 Under **Security**, select **Transfer Touch Control Logs to USB Device**.

A popup message displays when the log transfer completes successfully.





---

# Managing the System Remotely

You can configure, manage, and monitor the system from a computer using the system's web interface. You can also use the Polycom Global Management System, Polycom *ReadiManager* SE200 system, Polycom CMA system, RealPresence Resource Manager system, SNMP, or the API commands.

- The Polycom HDX Web Interface requires only a web browser.
- Polycom Global Management System, Polycom *ReadiManager* SE200 system, Polycom CMA system, and RealPresence Resource Manager system require the management application to be installed on your network.
- SNMP requires network management software on your network management station.
- For more information about the API commands, refer to the *Integrator's Reference Manual for Polycom HDX Systems*.

## Using the Polycom HDX Web Interface

You can use the Polycom RealPresence Room system's web interface to perform most of the calling and configuration tasks you can perform on the local system.

## Accessing the Polycom HDX Web Interface

**To configure your browser to use the Polycom RealPresence Room system's web interface:**

- 1 Be sure that you use Microsoft Internet Explorer 6.x, 7.x, or 8.0 as your web browser.
- 2 Configure the browser to allow cookies.

**To access the system using the Polycom RealPresence Room system's web interface:**

- 1 In your web browser address line, enter the HDX system's IP address, for example, `http://10.11.12.13`.

If Security Mode is enabled on the system, you must use secure HTTPS access, for example, `https://IPaddress` format. If you operate within a secure environment with the Maximum Security Profile or Security Mode enabled, you must use the `https://IPaddress` format. Click **Yes** in the security dialog boxes that appear.



Use the HTTPS protocol to ensure that the configuration of all login information (such as user names and passwords) are transmitted using an encrypted channel, including those user names and passwords used to communicate with third-party systems on your network. Using HTTPS severely limits the ability of anyone on the network to discover these credentials.

- 2 Enter the Admin ID as the user name (default is `admin`), and enter the Admin Remote Access Password, if one is set.

## Monitoring a Room or Call with the Polycom HDX Web Interface

The monitoring feature within the Polycom RealPresence Room system's web interface allows administrators of Polycom HDX systems to view a call or the room where the system is installed.

**To enable room and call monitoring:**

- 1 In the local interface, go to **System > Admin Settings > General Settings > Security > Security Settings** (select  if necessary).
- 2 Enable **Allow Video Display on Web** to allow the room or call to be viewed remotely.

**To monitor a room or call using the Polycom RealPresence Room system's web interface:**

- 1 In your web browser address line, enter the HDX system's IP address.
- 2 Go to **Utilities > Web Director**.
- 3 Perform any of the following tasks:
  - Place or end a call
  - View near and far sites
  - Change camera sources
  - Adjust camera position

- Zoom cameras
- Adjust system volume settings
- Mute and unmute the microphones

You can view near and far sites without opening Web Director by selecting **Tools > Remote Monitoring**.

## Managing System Profiles with the Polycom HDX Web Interface

Administrators managing systems that support multiple applications can change system settings using profiles. You can store a Polycom HDX system profile on a computer as a `.profile` file using the Polycom RealPresence Room system's web interface. The number of profiles you can save is unlimited.

The following settings are included in a profile:

- Home screen settings
- User access levels
- Icon selections
- Option keys
- System behaviors

Passwords are not included when you store a profile.



Polycom recommends using profiles only as a way to back up system settings. Attempting to edit a stored profile or upload a stored profile from one system to a different system can result in instability or unexpected results.

### To store a profile using the Polycom RealPresence Room system's web interface:

- 1 In your web browser address line, enter the HDX system's IP address.
- 2 Go to **Utilities > Profile Center**.
- 3 Click **HDX -> PC** to download the profile file from the Polycom HDX system.
- 4 Save the file to a location on your computer.

### To upload a profile using the Polycom RealPresence Room system's web interface:

- 1 Reset the Polycom HDX system to restore default settings.
- 2 In your web browser address line, enter the HDX system's IP address.
- 3 Go to **Utilities > Profile Center**.

- 4 Click **Browse** and browse to the location of the profile file on your computer.
- 5 Click **PC** → **HDX** to upload the .csv file to your system.

## Sending a Message

If you are experiencing difficulties with connectivity or audio, you may want to send a message to the system that you are managing.

Only the near site can see the message; it is not broadcast to all the sites in the call.

### To send a message using the Polycom RealPresence Room system's web interface:

- 1 In your web browser address line, enter the HDX system's IP address.
- 2 Enter the Admin ID as the user name (default is `admin`), and enter the Admin Remote Access Password, if one is set.
- 3 Go to **Diagnostics > Send a Message**.
- 4 In the Send a Message page, enter a message (up to 100 characters in length), then click **Send**.

The message is displayed for 15 seconds on the screen of the system that you are managing.

## Configuring Global Services

If your organization uses the Polycom Global Management System, you can configure, manage, and monitor the Polycom HDX system using the Global Management System server. Global Management System is a web-based client/server software tool that allows administrators to manage a network of video conferencing systems.

## Viewing the Management Servers List

On networks managed by the Global Management System, several Global Servers may be configured to manage this system remotely. The system also has a primary Global Management System server that performs account validation. You can view information about these servers, but this information can only be changed by the Global Management System Administrator.

**To view the management servers list:**

>> Do one of the following:

- In the local interface, go to **System > Admin Settings > Global Services > Management Servers**.
- In the web interface, go to **Admin Settings > Global Services > Management Servers**.

## Requiring an Account Number for Calls

If your system is set up for use with the Global Management System, the system can prompt the user to enter an account number before placing a call. The account number is added to the Global Management System's Call Detail Record (CDR) and the system's local CDR file (`localcdr.csv`), and this information can be used for call tracking and billing purposes.

If you do not configure the system to validate account numbers, calls are completed and the entered account number is recorded on the CDR. If you configure the system to validate account numbers, calls are completed only when placed using a valid account number. Account numbers are set up in Global Management System by the Global Management System administrator.



Requiring an account number for calls is not supported when the Polycom HDX system is paired with the Polycom Touch Control.

For more information about account validation, please contact your Global Management System administrator.

**To require an account number for calls:**

- 1 Do one of the following:
  - In the local interface, go to **System > Admin Settings > Global Services > Account Validation** (select  if necessary).
  - In the web interface, go to **System > Admin Settings > Global Services > Account Validation**.
- 2 Select **Require Account Number to Dial** to require an account number for placing calls and to require validation by the Global Management System server.

## Adding Information for the Global Management System Administrator

If your system is managed by Global Management System, you can configure the Polycom HDX system so that users can request help from the Global Management System administrator.





Configuring contact information for the Global Management System administrator is not supported when the Polycom HDX system is paired with the Polycom Touch Control.

### To configure Global Management contact information:

- 1 Do one of the following:
  - In the local interface, go to **System > Admin Settings > Global Services > My Information** (select  if necessary).
  - In the web interface, go to **Admin Settings > Global Services > My Information**.
- 2 Enter the contact information for the Global Management System administrator for technical support.

The following section illustrates the interaction between Global Management System and the system you are configuring.

## Requesting Technical Support from the Global Management System Administrator

If you need to contact the Global Management System administrator, press  on the remote control or keypad from the Place a Call screen, select **Support** and enter a phone number where the administrator can call you back. Then press . The administrator receives an alert to call you at the number you specified.



Requesting technical support from the Global Management System administrator is not supported with the Polycom HDX system is paired with the Polycom Touch Control.

## Setting Up SNMP

The Polycom HDX system sends SNMP (Simple Network Management Protocol) reports to indicate conditions, including the following:

- All alert conditions found on the Polycom HDX system alert page
- Details of jitter, latency, and packet loss

- Low battery power is detected in the remote control
- A system powers on
- Administrator logon is successful or unsuccessful
- A call fails for a reason other than a busy line
- A user requests help
- A telephone or video call connects or disconnects

Polycom HDX systems are compatible with SNMP versions 1 and 2c.

## Downloading MIBs

In order to allow your SNMP management console application to resolve SNMP traps and display human readable text descriptions for those traps, you need to install Polycom MIBs (Management Information Base) on the computer you intend to use as your network management station. The MIBs are available for download from the Polycom RealPresence Room system's web interface.

**To download the Polycom MIBs using the Polycom RealPresence Room system's web interface:**

- 1 In your web browser address line, enter the HDX system's IP address.
- 2 Go to **Admin Settings > Global Services > SNMP**.
- 3 Click **Download MIB** and follow the onscreen instructions.

## Configuring for SNMP Management

**To configure the Polycom HDX system for SNMP Management:**

- 1 Do one of the following:
  - In the local interface, go to **System > Admin Settings > Global Services > SNMP** (select  if necessary).
  - In the web interface, go to **Admin Settings > Global Services > SNMP**.

## 2 Configure these settings on the SNMP screen:

Setting	Description
<b>Enable SNMP</b>	Allows administrators to manage the system remotely using SNMP.
<b>Trap Version</b>	Specifies the trap protocol that the system uses. <ul style="list-style-type: none"> <li><b>v2c</b>—System uses the v2c trap.</li> <li><b>v1</b>—System uses the v1 trap.</li> </ul>
<b>Read-Only Community</b>	Specifies the SNMP management community in which you want to enable this system. The default community is <code>public</code> . <b>Note:</b> Polycom does not support SNMP write operations for configuration and provisioning; the read-only community string is used for both read operations and outgoing SNMP traps.
<b>Contact Name</b>	Specifies the name of the person responsible for remote management of this system.
<b>Location Name</b>	Specifies the location of the system.
<b>System Description</b>	Specifies the type of video conferencing device.
<b>Console IP Address</b>	Specifies the IP address of the computer you intend to use as your network management station and to which SNMP traps will be sent.

## Using a Provisioning Service

If your organization uses the Polycom CMA or RealPresence Resource Manager system, you can manage Polycom HDX systems in VC2 mode. In VC2 mode, which is also known as dynamic management mode, the following may be true:

- Register Polycom HDX systems with a standards-based presence service, so that presence states are shared with Contacts.
- Provide Polycom HDX systems with access to a corporate directory that supports LDAP access.
- The Domain, User Name, Password, and Server Address fields are populated on the Provisioning Service screen.
- Configuration settings that are provisioned, or that are dependent on provisioned values, are read-only on the Polycom HDX system.
- The Polycom HDX system checks for new software from the Polycom CMA or RealPresence Resource Manager system every time it restarts and at an interval set by the system. It automatically accesses and runs any software updates made available by the Polycom CMA or RealPresence Resource Manager system.



- A CMA or RealPresence Resource Manager system administrator can upload a provisioned bundle from an already configured HDX system. When HDX systems request provisioning, the provisioned bundle and any automatic settings are downloaded. An HDX system user with administrative rights can change the settings on the HDX system after the provisioned bundle is applied. If you later download a new provisioned bundle from the CMA or RealPresence Resource Manager system, the new bundle overwrites the manual settings.
- If the system has previously registered successfully with a provisioning service but fails to detect the service when it restarts or checks for updates, an alert appears on the System Status screen. If the system loses registration with the provisioning service, it continues operating with the most recent configuration that it received from the provisioning service.
- If a Polycom Touch Control is connected to a provisioned HDX system and the CMA or RealPresence Resource Manager system is running version 5.5 or later, the CMA or RealPresence Resource Manager system can receive status updates from and provide software updates to the Polycom Touch Control.

## Enabling or Disabling the Provisioning Service

You can register the Polycom HDX system with the Polycom CMA or RealPresence Resource Manager system in several ways:

- If the system detects a provisioning service on the network while running the setup wizard, it prompts you to enter information for registration with the service. Similarly, if the system detects provisioning data on a USB device while the running the setup wizard, it uses that information to attempt to register with the service.

The setup wizard is available during initial setup, after a software update or system reset with system settings deleted, or after using the restore button. For information about the USB device data, or about configuring the Polycom CMA or RealPresence Resource Manager system so that Polycom HDX systems detect and register with it, refer to the *Polycom Unified Communications Deployment Guide for Microsoft Environments*.

- You can enter the registration information and attempt to register in the Polycom HDX system's Admin Settings.

### To enable a provisioning service in the Admin Settings:

- 1 Do one of the following:
  - In the local interface, go to **System > Admin Settings > Global Services > Provisioning Service** (select  if necessary).
  - In the web interface, go to **Admin Settings > Global Services > Provisioning Service**.

- 2 Enter the Domain, User Name, Password, and Server Address for automatic provisioning. Multiple Polycom HDX systems can be registered to a single user.

When operating within a maximum security environment, Polycom requires that the CMA or RealPresence Resource Manager system administrator assign a unique machine account user name and password to use for each HDX system you enable for provisioning.

- 3 Select **Register** or **Update**. The system tries to register with the Polycom CMA or RealPresence Resource Manager system using NTLM authentication.

#### To disable a provisioning service:

To disable automatic provisioning on a Polycom HDX system, run the setup wizard and cancel registration with the provisioning service.

The setup wizard is available during initial setup, after a software update or system reset with system settings deleted, and after using the restore button.

Remove your information from the Provisioning Service screen when it appears in the setup wizard. Then select **Cancel** when you get the message that registration failed.

### Provisioning Service Settings

If automatic provisioning is enabled but the system does not register successfully with the provisioning service, you might need to change the Domain, User Name, Password, or Server Address used for registration. For example, users might be required to periodically reset passwords used to log into the network from a computer. If such a network password is also used as the provisioning service password, you must update it on the Polycom HDX system, too. To avoid unintentionally locking a user out of network access in this case, Polycom HDX systems will not automatically retry registration until you update the settings and register manually on the Provisioning Service screen.

#### To configure the provisioning service settings:

- 1 Do one of the following:
  - In the local interface, go to **System > Admin Settings > Global Services > Provisioning Service** (select  if necessary).
  - In the web interface, go to **Admin Settings > Global Services > Provisioning Service**.

## 2 Configure these settings.

Setting	Description
<b>Domain</b>	Specifies the domain for registering to the provisioning service.
<b>User Name</b>	Specifies the endpoint's user name for registering to the provisioning service.
<b>Password</b>	Specifies the password that registers the system to the provisioning service.
<b>Server Address</b>	Specifies the address of the Polycom CMA or RealPresence Resource Manager system running the provisioning service.

## Keeping your Software Current

You can update your Polycom HDX system by going to [support.polycom.com](http://support.polycom.com), navigating to **Documents and Downloads > Telepresence and Video**, and then downloading and installing the appropriate software. You can download and install software for the Polycom Touch Control and Polycom EagleEye Director, with no software or options key codes. You can also download and install Polycom Touch Control software from a web server.

Refer to the *Release Notes for Polycom HDX Systems* for information about the latest software version, including version dependencies. Refer to *Installing Software and Options for Polycom HDX Systems and Accessories* for detailed information about obtaining software key codes and updating your software.



If your organization uses a management system for provisioning endpoints, your Polycom HDX system might get software updates automatically.



---

# Control Devices

## Configuring Remote Control Behavior

You can customize the behavior of the remote control to support the users' environment.



### Points to Note about remote control behavior:

- If the Polycom HDX system is paired and connected with a Polycom Touch Control, the remote control is disabled.
- Polycom HDX 8000 series, Polycom HDX 7000 series, and Polycom HDX 6000 series systems *must* be connected to a camera with an IR receiver to receive signals from the remote control. Be sure to point the remote control at the camera to control those Polycom HDX systems. Refer to the “Interoperability” section of the current HDX system release notes for a list of supported cameras with IR receivers.
- The Polycom HDX remote control IR transmits a modulated frequency of 38 kHz.

### To configure remote control behavior:

- 1 Do one of the following:
  - In the local interface, go to **System > Admin Settings > General Settings > System Settings > Remote Control/Keypad** (select  if necessary).
  - In the web interface, go to **Admin Settings > General Settings > System Settings**.

## 2 Configure these settings:

Setting	Description
<b>Keypad Audio Confirmation</b>	Specifies whether to play a voice confirmation of numbers selected with the remote control or keypad.
<b>Numeric Keypad Function</b>	Specifies whether pressing number buttons on the remote control or keypad moves the camera to presets or generates touch tones (DTMF tones). If this is set to <b>Presets</b> , users can generate DTMF tones by pressing  while on a video screen.
<b>Use Non-Polycom Remote</b>	Configures the system to accept input from a programmable, non-Polycom remote control. In most cases the Polycom remote works as designed, even when this feature is enabled. However, try disabling this feature if you experience difficulty with the Polycom remote. For more information about Polycom HDX system IR codes, refer to the <i>Integrator's Reference Manual for Polycom HDX Systems</i> .
<b>Channel ID</b>	Specifies the IR identification channel to which the Polycom HDX system responds. Set the Channel ID to the same channel as the remote control. The default setting is 3. If the remote control is set to channel 3, it can control a Polycom HDX system set to any Channel ID. For more information about changing this setting, refer to <a href="#">Configuring the Remote Control Channel ID</a> .
<b>Chinese Virtual Keyboard</b>	Specifies the type of onscreen keyboard to display for Simplified Chinese. This setting is only available when the system's Language is set to Simplified Chinese.
<b>Power Button Function</b>	Specifies the behavior of the remote control Power button. <ul style="list-style-type: none"> <li>• <b>Power On or Off</b>—Specifies that holding down the <b>Power</b> button on the remote control powers off the HDX system, and pressing the Power button when the system is off powers the system on.</li> <li>• <b>Sleep or Wake</b>—Specifies that pressing the <b>Power</b> button on the remote control puts the system to sleep or wakes it up.</li> <li>• <b>Disabled</b>—Disables the <b>Power</b> button on the remote control.</li> </ul>

## Configuring the Remote Control Channel ID

You can configure the Channel ID so that the remote control affects only one Polycom HDX system, even if other systems are in the same room.









The Polycom Touch Control virtual remote control is always set to channel 3.

If the remote control is set to channel 3, it can control a Polycom HDX system set to any Channel ID. If the system does not respond to the remote control, set the remote control channel ID to 3 starting with step 3 in the following procedure. Then follow the entire procedure to configure the system and remote control channel ID settings.



The **Power** button affects any HDX system within the range of the remote control, regardless of the Channel ID setting.

### To configure the channel ID for a Polycom HDX system and remote control:

- 1 Do one of the following:
  - In the local interface, go to **System > Admin Settings > General Settings > System Settings > Remote Control/Keypad** (select  if necessary).
  - In the web interface, go to **Admin Settings > General Settings > System Settings**.
- 2 Set the **Channel ID**.
- 3 While blocking the IR signal from the remote control using your hand or some other object, press and hold the  **Option** button for 5 seconds.
- 4 Press  once to **Set ID**.
- 5 Press the right arrow to change the setting.
- 6 Press  or  to select the channel ID that you configured on the system.
- 7 Press  to select the new setting.



## Configuring the Remote to Control a Recording Device



You can program the Polycom HDX system remote control to control a specific recording or playback device such as a VCR or DVD player.

For a list of codes, refer to [Appendix D, Codes for Remote Control Recording Device Buttons](#) on page D-1.

**To program the remote to control a recording device:**

- 1 Press and hold the  **Option** button for 5 seconds.
- 2 Press the right arrow to select **Set Code**.
- 3 Enter the four-digit code for your recording device.
- 4 Press  to select the new setting.

The remote control can also be used to control a Polycom RSS™ 4000 system by sending audible DTMF tones across the call. For more information, refer to the *Polycom RSS 4000 User Guide* available on the Polycom web site.

## Connecting Control and Accessibility Equipment

The Polycom HDX 9004 provides two serial ports. The Polycom HDX 9002, Polycom HDX 9001, Polycom HDX 8000 series, Polycom HDX 7000 series, and Polycom HDX 4000 series systems provide one serial port. Depending on your system's capabilities, you may be able to use the RS-232 serial ports to:

- Connect a modem and use a closed captioning service
- Pass data from a device connected to your system to a device connected to the far site system
- Control the system through a touch-panel using the API
- Provide control signals for an additional camera
- Provide control signals for a Polycom Vortex mixer



You will need to configure the RS-232 equipment according to the manufacturer's instructions, and you will need to configure the RS-232 serial port on the system exactly the same way.

Make sure that the system is powered off before you connect devices to it.

## Connecting Non-Polycom Touch-Panel Controls

You can connect an AMX or Crestron control panel to a Polycom HDX 9000 series or Polycom HDX 8000 series system RS-232 serial port as part of a custom room installation. You will need to program the control panel. Refer to the *Integrator's Reference Manual for Polycom HDX Systems* for information about the API commands.

## Connecting IR Sensors to Polycom HDX Systems

The Polycom HDX 9000 series provides a connector for an external IR sensor. Refer to your system's setup sheet for connection details.



The Polycom HDX 9000 series is compatible with the following IR sensors:

- Xantech® 480-00
- Xantech 490-90
- Xantech 780-80
- Xantech 780-90

## Configuring RS-232 Serial Port Settings

- 1 Do one of the following:
  - In the local interface, go to **System > Admin Settings > General Settings > Serial Port** (select  if necessary).
  - In the web interface, go to **Admin Settings > General Settings > Serial Port**.
- 2 Configure these settings for a Polycom HDX 9000 series, Polycom HDX 8000 series, Polycom HDX 7000 series, or Polycom HDX 4000 series system:

Setting	Description
<b>RS-232 Mode</b>	<p>Specifies the mode used for the serial port. Available settings depend on the Polycom HDX system model.</p> <ul style="list-style-type: none"> <li>• <b>Off</b>—Disables the serial port.</li> <li>• <b>Control</b>—Receives control signals from a touch-panel control. Allows any device connected to the RS-232 port to control the system using API commands.</li> <li>• <b>Camera PTZ</b>—Provides control signals to a PTZ camera.</li> <li>• <b>Closed Caption</b>—Receives closed captions from a captioning service using a modem, or directly from a captioner's computer via Telnet.</li> <li>• <b>Vortex Mixer</b>—Provides control signals to a Polycom Vortex mixer.</li> <li>• <b>Pass Thru</b>—Passes data to an RS-232 device connected to the serial port of the far-site system.</li> <li>• <b>Polycom Annotation</b>—Provides control signals to the Polycom Instructor™ FS.</li> <li>• <b>Interactive Touch Board</b>—Provides control signals to a Polycom SMART board device.</li> </ul>
<b>Baud Rate, Parity, Data Bits, Stop Bits</b>	Set these to the same values that they are set to on the serial device.

Setting	Description
<b>RS-232 Flow Control</b>	When a Vortex is connected to an RS-232 connector on the Polycom HDX system, set both to <b>Hardware</b> . This is selectable when <b>RS-232 Mode</b> is set to <b>Vortex Mixer</b> or <b>Pass Thru</b> .
<b>Camera Control</b>	Specifies which camera to control when <b>RS-232 Mode</b> is set to <b>Camera PTZ</b> .
<b>Detect Camera</b>	Detects the camera specified for <b>Camera Control</b> .

- For a Polycom HDX 9004, select  if necessary, and configure the settings for port 2.

## Setting Up the Polycom Touch Control Device

The Polycom Touch Control allows you to control a Polycom HDX system.

Follow these steps to get started with the Polycom Touch Control. Refer to the *Setting Up the Polycom Touch Control* and *Installing Software and Options for Polycom HDX Systems and Accessories* documents for more information.

### To set up the Polycom Touch Control Device:

- Ensure that the correct software is installed on the Polycom HDX system that you want to control, and that you have completed the setup wizard on the HDX system.  
*Refer to *Installing Software and Options for Polycom HDX Systems and Accessories* for more information about updating the Polycom Touch Control software.*
- Connect the Ethernet cable to the underside of the Polycom Touch Control.
- If you intend to use the Polycom Touch Control to show content from a computer, connect the USB cable to the underside of the Polycom Touch Control.
- If you want to connect the stand, route the Ethernet and USB cables through the opening in the stand. Then attach the stand to the Polycom Touch Control by tightening the mounting screw with a screwdriver.
- Plug the Ethernet cable into the wall outlet:
  - If your network connection to the Polycom Touch Control provides Power over Ethernet (PoE), you can connect the Ethernet cable directly to the LAN outlet.

- If your network connection to the Polycom Touch Control does not provide PoE, you must connect the Ethernet cable to the power supply adapter. Then connect the power supply adapter to a LAN outlet and power outlet. Be sure to plug the male end into a LAN outlet in the wall.

The Polycom Touch Control powers on and displays the language selection screen.

- 6 Choose your language and follow the onscreen instructions to pair the Polycom Touch Control with your HDX system, or select **Pair Later** on the Pairing screen to skip pairing.
- 7 After the Polycom Touch Control connects to the network, enter the HDX system IP address and touch **Connect**. By default, the IP address of the HDX system is displayed on the bottom of its Home screen. If the HDX system is configured to allow pairing and you enter the IP address for the system correctly, the Touch Control displays a prompt for the Polycom HDX system admin user ID and password.

When the Polycom Touch Control has paired and connected with the HDX system, the Polycom Touch Control displays a success message, and the menus on the HDX system monitor become unavailable. For more information about pairing, refer to [Pairing](#) on page 10-8.



The Polycom Touch Control is supported with the SoundStation IP 7000 phone when both are connected to an HDX system.

## Pairing and Unpairing a Polycom Touch Control Device and a Polycom HDX System

When you configure the Polycom Touch Control to pair with a particular Polycom HDX system, the Polycom Touch Control makes an IP connection to the HDX system. If the connection is lost for any reason, the Polycom Touch Control automatically attempts to restore the connection.

The Polycom Touch Control connects to the HDX system over a TLS socket, providing a reliable, secure communication channel between the two systems. The Polycom Touch Control initiates all pairing connections and attaches to port 4122 on the HDX system.

You can pair the Polycom Touch Control and Polycom HDX system during initial Polycom Touch Control setup, as described in the steps on the previous page.

After you have completed Polycom Touch Control setup, you can pair to a different HDX system using Polycom Touch Control settings and unpair using the web interface. Refer to [Pairing](#) on page 10-8 for more information.

The following table describes the pairing states:

State	Description
<b>Paired</b>	The Polycom Touch Control is successfully connected to the Polycom HDX system through the pairing process, including providing the Polycom HDX admin ID and password. A single Polycom Touch Control can be paired to multiple Polycom HDX systems and, once paired, the Polycom Touch Control can switch between HDX systems without needing to enter admin IDs or passwords.
<b>Unpaired</b>	The ability to pair or connect to the Polycom Touch Control is disabled on the Polycom HDX system. The only way to unpair is to follow the <a href="#">Unpairing</a> procedure on page 10-9.
<b>Connected</b>	A Polycom Touch Control has an active pairing connection to the Polycom HDX system. A single Polycom Touch Control can be paired to multiple Polycom HDX systems, but can be connected to only one HDX system at a time.
<b>Disconnected</b>	The Polycom Touch Control does not have an active pairing connection to an HDX system, but is still paired if at least one HDX system that has previously paired with the Polycom Touch Control has not unpaired.

## Pairing

### To pair the Polycom Touch Control and Polycom HDX system during setup:

- >> After selecting a language, enter the HDX system IP address in the Polycom Touch Control interface and touch **Connect**.



If you do not wish to pair during setup, select **Pair Later**. If you choose to skip pairing, many Polycom Touch Control features are not available. You can pair at a later time.

### To pair the Polycom Touch Control and Polycom HDX system after setup:

- 1 On the Polycom Touch Control Home screen, touch **System**.
- 2 Scroll to **Device Connection Status** and then touch  Info next to the HDX system.
- 3 Touch **View Pairing Settings**.
- 4 Change the HDX system IP address and touch **Connect**.

After the HDX system and the Polycom Touch Control are paired, the HDX system web interface and the Polycom Touch Control interface display information about each other and about their connection status.



Do not pair the Polycom HDX system with a Polycom Touch Control if the HDX system's security profile requires users to enter a user name and password or if the Polycom HDX system is configured to display a security banner.

## Unpairing

You can unpair the Polycom Touch Control and HDX system using the web interface.

### To unpair the Polycom Touch Control and Polycom HDX using the web interface:

- 1 In the web interface, select **Admin Settings > Polycom Touch Control**.
- 2 Disable **Allow Polycom Touch Control to Pair with this System** or select **Forget this Device**.

The HDX system cannot pair with any Polycom Touch Control while **Allow Polycom Touch Control to Pair with this System** is disabled.



## Statistics and Diagnostics

The Polycom HDX system provides various screens that allow you to review information about calls made by the system and to review network usage and performance.

### Diagnostics Screens

The following Diagnostics screens are available on the system and in the Polycom HDX web interface.

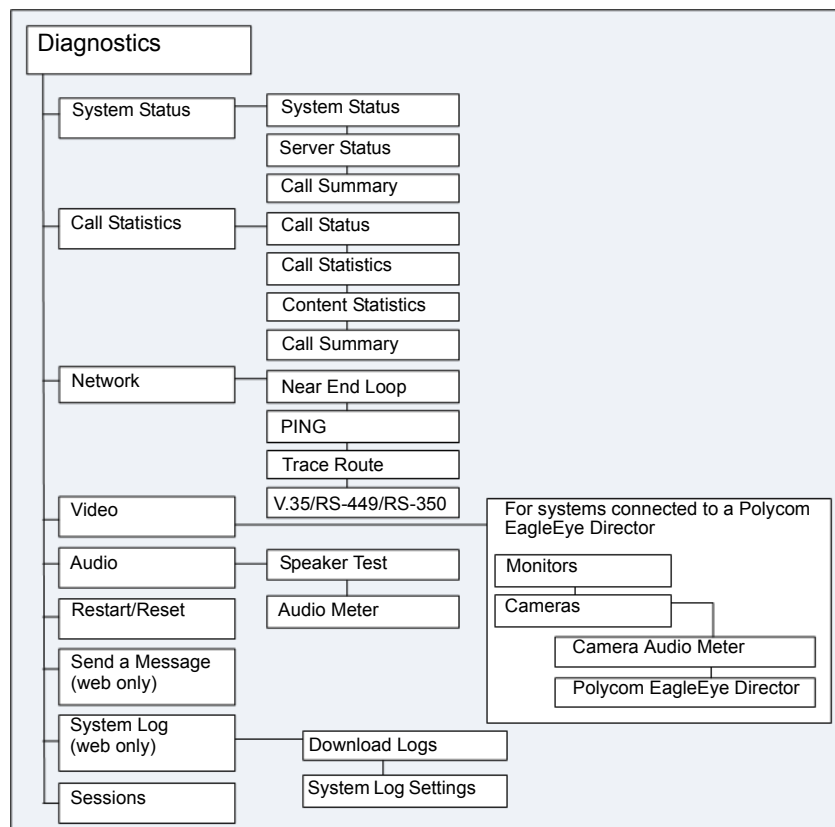

**To access the Diagnostics screens on the system:**

- >> Go to **System > Diagnostics**.
- >> To access the EagleEye Director Video Diagnostics screen, go to **System > Diagnostics > Video > Cameras > Polycom EagleEye Director**.

**To access the Diagnostics screens using the Polycom HDX web interface:**

- 1 In your web browser address line, enter the HDX system's IP address.
- 2 Enter the Admin ID as the user name (default is `admin`), and enter the Admin Remote Access Password, if one is set.
- 3 Click **Diagnostics** from any page in the Polycom HDX web interface.  
For EagleEye Director Video Diagnostics, go to **Diagnostics > Video > Cameras > Polycom EagleEye Director**.

## System Status

Diagnostic Screen	Description
System Status	<p>Displays system status information, including auto-answer point to point, remote control battery, IP network, meeting password, log threshold, ISDN lines, and UC Board.</p> <p>For an explanation of any of the status items, select the item and press  on the remote. If the Polycom HDX system is paired with a Polycom Touch Control, go to <b>Diagnostics &gt; System Status</b> in the web interface for an explanation of any of the status items.</p> <p>If the Polycom HDX system detects an EagleEye Director, a status line for <b>Camera Software Compatibility</b> is also displayed.</p> <p>When a change occurs in the system status or a potential problem, you see an alert at the bottom of the Polycom HDX Home screen.</p>



## Server Status



Diagnostic Screen	Description
Server Status	<p>Displays server status information, including time server, global directory, provisioning service, presence service, and gatekeeper.</p> <p>For an explanation of any of the status items, select the item and press  on the remote. If the Polycom HDX system is paired with a Polycom Touch Control, go to <b>Diagnostics &gt; System Status</b> in the web interface for an explanation of any of the status items.</p> <p>When a change occurs in the server status or a potential problem, you see an alert at the bottom of the Polycom HDX Home screen.</p>

## Call Summary

Diagnostic Screen	Description
Call Summary	<p>Displays calling information, such as:</p> <ul style="list-style-type: none"> <li>• Duration of the last call</li> <li>• Total number of calls placed and received</li> <li>• Number, total time, and percentage of IP calls</li> <li>• Number, total time, and percentage of ISDN calls</li> </ul>

## Call Statistics

In the web interface, all Call Statistics are shown on one screen. The following table describes how the statistics appear in the local interface.

Diagnostic Screen	Description
Call Statistics	<p>Displays information about the call in progress. In multipoint calls, the Call Statistics screens show most of this information for all systems in the call.</p> <p>If the Polycom HDX system is not paired with a Polycom Touch control device, view call statistics by pressing  on the remote.</p> <p>If the Polycom HDX system is paired with a Polycom Touch Control, view call statistics by touching  on the Call screen and then touching <b>View Call Statistics</b>.</p>

Diagnostic Screen	Description
Call Statistics (continued)	<p>Call Statistics:</p> <ul style="list-style-type: none"> <li>• Call speed (transmit and receive)</li> <li>• Video protocol, annexes, and format in use (transmit and receive). The video protocol is shown in green if the system is currently using error concealment.</li> <li>• Audio protocol in use (transmit and receive). The audio protocol is shown in green if the system is currently using error concealment.</li> <li>• Number of packets lost and percentage packet loss (transmit and receive) in IP calls</li> <li>• Encryption type, key exchange algorithm type, and key exchange check code (if the encryption option is enabled and the call is encrypted)</li> <li>• Far site details and call type</li> <li>• Audio and video data rates specified (transmit and receive)</li> <li>• Video data rate and frame rate in use (transmit and receive)</li> <li>• Video packet loss and jitter in IP calls</li> <li>• Audio packet loss, jitter, and maximum jitter in IP calls</li> <li>• Video forward error concealment (FEC) errors</li> </ul>
Content Statistics	<p>The Content Statistics screen shows statistics for content shared during a call.</p>
Call Status	<p>Displays call type, data speed, and number dialed for the current call. You can highlight the spheres on this screen to see the number dialed, the relevant status code, and details of any errors.</p> <p>In ISDN calls, this screen also displays connection status for each channel.</p> <p>In calls placed through a V.35/RS-449/RS-530 network interface, this screen displays the states of these signals:</p> <ul style="list-style-type: none"> <li>• DTR</li> <li>• RTS</li> <li>• CTS</li> <li>• DSR</li> <li>• DCD</li> <li>• RI</li> </ul> <p>Bright indicators show high signals; dim indicators show low signals.</p>
Call Summary (system only)	<p>This is the same information that is displayed under System Status.</p>

## Network

Diagnostic Screen	Description
Near End Loop	<p>Tests the internal audio encoders and decoders, the external microphones and speakers, the internal video encoders and decoders, and the external cameras and monitors.</p> <p>Monitor 1 displays the video and plays the audio that would be sent to the far site in a call.</p> <p>This test is not available when you are in a call.</p>
PING	<p>Tests whether the system can establish contact with a far-site IP address that you specify.</p> <p>PING returns abbreviated Internet Control Message Protocol results. It returns H.323 information only if the far site is configured for H.323. It returns SIP information only if the far site is configured for SIP.</p> <p>If the test is successful, the Polycom HDX system displays a message indicating that the IP address under test is available.</p>
Trace Route	<p>Tests the routing path between the local system and the IP address entered.</p> <p>If the test is successful, the Polycom HDX system lists the hops between the system and the IP address you entered.</p>
V.35/RS-449/RS-530 Serial Status screen (system only)	<p>Displays the states of these signals:</p> <ul style="list-style-type: none"> <li>• DTR</li> <li>• RTS</li> <li>• CTS</li> <li>• DSR</li> <li>• DCD</li> <li>• RI</li> </ul> <p>Bright indicators show high signals; dim indicators show low signals.</p>

## Video (Monitors)

Diagnostic Screen	Description
Video Diagnostics	<p>Tests the color settings of your monitor for optimum picture quality.</p> <p>If the color bars generated during the test are not clear, or the colors do not look correct, the monitor needs to be adjusted.</p> <p><b>Note:</b> For HDX systems using a Polycom EagleEye Director, this test is under <b>Diagnostics &gt; Video &gt; Monitor</b>.</p>

## Video Cameras

The **Diagnostics > Video > Cameras** settings display only when the HDX system detects a Polycom EagleEye Director.

Diagnostic Screen	Description
Camera Audio Meter	<p>Verifies microphone functionality. To use this feature, speak aloud and verify that you can see dynamic signal indications for two vertical microphones and five horizontal microphones. If no signal indication appears for a specific microphone, manually power off the EagleEye Director and then power it back on.</p> <p>Also verifies the reference audio signal: Set up a video call. Let the far side speak aloud and verify that you can see dynamic signal indications for the two reference audio meters. If no signal indication appears for a specific microphone, make sure the reference cable is connected firmly.</p> <p>After you verify microphone functionality, calibrate the camera again.</p>
Polycom EagleEye Director > Camera Video Diagnostics	<p><b>Left Camera</b> shows video from the left camera.</p> <p><b>Right Camera</b> shows video from the right camera.</p> <p><b>Color Bars</b> displays the color bar test screen.</p>

## Audio

Diagnostic Screen	Description
Speaker Test	<p>Tests the audio cable connections. A 473 Hz audio tone indicates that the local audio connections are correct.</p> <p>If you run the test from the system during a call, the far site will also hear the tone.</p> <p>If you run the test from the Polycom HDX web interface during a call, the people at the site you are testing will hear the tone, but you will not.</p>
Audio Meter	<p>Measures the strength of audio signals from the microphone or microphones, far-site audio, VCR audio, and any device connected to the audio line in.</p> <ul style="list-style-type: none"> <li>• To check the microphone or microphones, speak into the microphone.</li> <li>• To check far-site audio, ask a participant at the far site to speak or call a phone in the far-site room to hear it ring.</li> <li>• To check a VCR or DVD, connect it to the VCR inputs and play the VCR or DVD to test the audio.</li> </ul> <p>The Audio Meters indicate peak signal levels. Set signal levels so that you see peaks between +3dB and +7dB with normal speech and program material. Occasional peaks of +12dB to +16dB with loud transient noises are considered acceptable. A meter reading of +20dB corresponds to 0dBFS in the Polycom HDX system audio. A signal at this level is likely clipping the audio system.</p> <p>Meters function only when the associated input is enabled.</p> <p><b>Note:</b> Some audio meters are unavailable when a SoundStructure digital mixer is connected to the Polycom HDX system.</p>

## Reset or Restart System

Diagnostic Tool	Description
Restart (web only) Reset System (system only)	<p>Restart in the web interface cycles power to the system.</p> <p><b>Note:</b> If a password is set, you must enter it to reset the system.</p> <p>When you choose <b>Reset System</b> using the remote control, the system's user interface allows you to do the following:</p> <ul style="list-style-type: none"> <li>• Keep your system settings (such as system name and network configuration) or restore factory settings.</li> <li>• Keep or delete the directory stored on the system. System reset does not affect the global directory.</li> </ul> <p>You may want to download the CDR and CDR archive before you reset the system. Refer to <a href="#">Call Detail Report (CDR)</a> on page 11-9.</p>

## Send a Message

This setting appears in the web interface only. Use this setting to send a message to the embedded interface of a Polycom HDX system you are managing.

## System Log

This setting appears in the web interface only. For information about using system logs, refer to [System Logs](#) on page 11-13.

## Sessions

This setting appears in the local interface only. When you select the setting, information about the sessions that are currently running on the HDX system is displayed.

Diagnostic Screen	Description
<b>Type</b>	Displays the type of connection, for example, Web.
<b>User ID</b>	Displays the ID of each user who is logged in.
<b>Remote Address</b>	Displays the IP addresses of people logged in to the HDX system from their computers.
<b>Duration</b>	Displays the duration of the session in hours, minutes, and seconds for each user currently logged in.
<b>Idle</b>	Displays how long the session has been idle, in seconds.

## Recent Calls

When the **Call Detail Report** setting is enabled, Recent Calls shows a list of up to 99 calls made by the system. It includes the following information:



- Site name or number
- Date and time
- Call in or out

The Recent Calls list shows incoming and outgoing calls that connect, as well as outgoing calls that do not connect. You can view information about each call, including the far site's number and name, and the type, speed (bandwidth), and duration of the call.



If Do Not Disturb has been enabled, any incoming calls attempted by other sites will not be listed.

The home screen can be configured to include Recent Calls. For more information about including the Recent Calls list on the Polycom HDX Home screen, refer to [Customizing the Home Screen](#) on page 7-3.

### To view the Recent Calls screen using the remote control or keypad:

- 1 Go to **System > Admin Settings > Network > Recent Calls** (select  if necessary).
- 2 Highlight an entry and press  on the remote or keypad.

### To view the Recent Calls screen using the Polycom Touch Control:

- 1 If the Polycom HDX system is paired with the Polycom Touch Control, touch  **Place a Call**.
- 2 Touch **Recent Calls**.
- 3 Touch  **Info** next to the entry you want to view.

If you need even more detail about calls, you can view or download the Call Detail Report (CDR) from the Polycom HDX web interface. For more information about the CDR, refer to the following section, [Call Detail Report \(CDR\)](#).

## Call Detail Report (CDR)

When enabled, the Call Detail Report (CDR) provides the system's call history. You can view the CDR from the Polycom HDX web interface. Within 5 minutes of the end of the call, the CDR is written to memory and then you can download the data in CSV format for sorting and formatting.

Every call that connects is added to the CDR, whether it is a call that you make or that you receive. If a call does not connect, the report shows the reason. In multipoint calls, each far site is shown as a separate call, but all have the same conference number.

The CDR does not include incoming calls that the Polycom HDX system does not answer, so if calls were missed while Do Not Disturb was enabled, details will not be included in the CDR.

#### To view and download the CDR using the Polycom HDX web interface:

- 1 In your web browser address line, enter the HDX system's IP address.
- 2 Enter the Admin ID as the user name (default is `admin`), and enter the Admin Remote Access Password, if one is set.
- 3 Click **Utilities > Call Detail Report** to view the details of the file.
- 4 Click **Save** and then specify a location on your computer to save the file.

## Information in the CDR

The following table describes the data fields in the CDR.

Data	Description
Row ID	Each call is logged on the first available row. A call is a connection to a single site, so there may be more than one call in a conference.
Start Date	The call start date, in the format dd-mm-yyyy.
Start Time	The call start time, in the 24-hour format hh:mm:ss.
End Date	The call end date.
End Time	The call end time.
Call Duration	The length of the call.
Account Number	If Require Account Number to Dial is enabled on the system, the value entered by the user is displayed in this field.
Remote System Name	The far site's system name.
Call Number 1	The number dialed from the first call field, not necessarily the transport address. For incoming calls — The caller ID information from the first number received from a far site.



Data	Description
Call Number 2 (If applicable for call)	For outgoing calls — The number dialed from the second call field, not necessarily the transport address. For incoming calls — The caller ID information from the second number received from a far site.
Transport Type	The type of call — Either H.320 (ISDN), H.323 (IP), or SIP.
Call Rate	The bandwidth negotiated with the far site.
System Manufacturer	The name of the system manufacturer, model, and software version, if they can be determined.
Call Direction	In — For calls received. Out — For calls placed from the system.
Conference ID	A number given to each conference. A conference can include more than one far site, so there may be more than one row with the same conference ID.
Call ID	Identifies individual calls within the same conference.
Total H.320 Channels Used	The total number of ISDN B channels used in the call. For example, a 384K call would use six B channels.
Endpoint Alias	The alias of the far site.
Endpoint Additional Alias	An additional alias of the far site.
Endpoint Remote Type	Terminal, gateway, or MCU.
Endpoint Transport Address	The actual address of the far site (not necessarily the address dialed).
Audio Protocol (Tx)	The audio protocol transmitted to the far site, such as G.728 or G.722.1.
Audio Protocol (Rx)	The audio protocol received from the far site, such as G.728 or G.722.
Video Protocol (Tx)	The video protocol transmitted to the far site, such as H.263 or H.264.
Video Protocol (Rx)	The video protocol received from the far site, such as H.261 or H.263.
Video Format (Tx)	The video format transmitted to the far site, such as CIF or SIF.
Video Format (Rx)	The video format received from the far site, such as CIF or SIF.
Disconnect Local ID and Disconnect Reason	The description of the Q.850 (ISDN) cause code showing how the call ended.

Data	Description
Q.850 Cause Code	The Q.850 cause code showing how the call ended.
Total H.320 Errors	The number of errors during an H.320 call.
Average Percent of Packet Loss (Tx)	The combined average of the percentage of both audio and video packets transmitted that were lost during the 5 seconds preceding the moment at which a sample was taken. This value does not report a cumulative average for the entire H.323 call. However, it does report an average of the sampled values.
Average Percent of Packet Loss (Rx)	The combined average of the percentage of both audio and video packets received that were lost during the 5 seconds preceding the moment at which a sample was taken. This value does not report a cumulative average for the entire H.323 call. However, it does report an average of the sampled values.
Average Packets Lost (Tx)	The number of packets transmitted that were lost during an H.323 call.
Average Packets Lost (Rx)	The number of packets from the far site that were lost during an H.323 call.
Average Latency (Tx)	The average latency of packets transmitted during an H.323 call based on round-trip delay, calculated from sample tests done once per minute.
Average Latency (Rx)	The average latency of packets received during an H.323 call based on round-trip delay, calculated from sample tests done once per minute.
Maximum Latency (Tx)	The maximum latency for packets transmitted during an H.323 call based on round-trip delay, calculated from sample tests done once per minute.
Maximum Latency (Rx)	The maximum latency for packets received during an H.323 call based on round-trip delay, calculated from sample tests done once per minute.
Average Jitter (Tx)	The average jitter of packets transmitted during an H.323 call, calculated from sample tests done once per minute.
Average Jitter (Rx)	The average jitter of packets received during an H.323 call, calculated from sample tests done once per minute.
Maximum Jitter (Tx)	The maximum jitter of packets transmitted during an H.323 call, calculated from sample tests done once per minute.
Maximum Jitter (Rx)	The maximum jitter of packets received during an H.323 call, calculated from sample tests done once per minute.

## Call Detail Report Archives

Calls are added to the CDR until the file size reaches 50 KB, which is equivalent to about 150 calls. The system then automatically archives the CDR and creates a new CDR file. If an archive is already present, the new archive overwrites it.

The CDR starts with Row 1, but the conference numbers continue from the file most recently archived. Conference numbering restarts at 1 after the system assigns conference number 100,000.

### To view and download a CDR archive using the Polycom HDX web interface:

- 1 In your web browser address line, enter the HDX system's IP address.
- 2 Enter the Admin ID as the user name (default is `admin`), and enter the Admin Remote Access Password, if one is set.
- 3 Click **Utilities > Call Detail Report** to view the details of the file.
- 4 Click **Save** and then specify a location on your computer to save the file.

## System Logs

You can use the Polycom HDX system local interface or web interface to download system logs. For information about downloading logs from the local interface, refer to [Setting up Log Management](#) on page 8-41.

You can also manage Polycom Touch Control log files from the Touch Control interface. For more information about Polycom Touch Control log management, refer to [Managing Polycom Touch Control Logs](#) on 8-43.

## Downloading System Logs from the Polycom HDX Web Interface

The support information package contains logs, configuration settings, and other diagnostic information.

### To download a system log using the Polycom HDX web interface:

- 1 In your web browser address line, enter the HDX system's IP address.
- 2 Enter the Admin ID as the user name (default is `admin`), and enter the Admin Remote Access Password, if one is set.
- 3 Click **Diagnostics > System Log > Download Logs**.
- 4 Click **Download support information package** and then specify a location on your computer to save the file.

## System Log Settings in the Polycom HDX Web Interface

### To configure system log settings using the Polycom HDX web interface:

- 1 In your web browser address line, enter the HDX system's IP address.
- 2 Enter the Admin ID as the user name (default is `admin`), and enter the Admin Remote Access Password, if one is set.
- 3 Click **Diagnostics > System Log > System Log Settings**.
- 4 Configure these settings:

Setting	Description
<b>Log Level</b>	Sets the minimum log level of messages stored in the Polycom HDX system flash memory. <b>DEBUG</b> logs all debugging messages. <b>INFO</b> logs all debug, informational, and warning messages. <b>WARNING</b> logs all warning and error messages.  Polycom recommends leaving this setting at the default value of <b>DEBUG</b> .
<b>Remote Logging Enabled</b>	Specifies whether remote logging is enabled. Enabling this setting causes the Polycom HDX system to send each log message to the specified server in addition to logging it locally.  The system immediately begins forwarding its log messages when you click <b>Update</b> .  Encryption is not supported for remote logging, so Polycom recommends remote logging only for secure, local networks.
<b>Remote Log Server</b>	Specifies the domain name or IP address of the syslog server. The server must support the standard syslog protocol (RFC 3164).
<b>Enable ISDN Trace</b>	Logs additional ISDN connectivity information.
<b>Enable H.323 Trace</b>	Logs additional H.323 connectivity information.
<b>Enable SIP Trace</b>	Logs additional SIP connectivity information.

## Downloading EagleEye Director Logs

The Polycom EagleEye Director logs contain important status and debug information that is not included in the logs available for the HDX system.

Follow these steps to download the log information to a USB device:

- 1 Attach a USB storage device formatted in FAT32 to the back panel of the EagleEye Director.

- 2** Restart the EagleEye Director by following these steps:
  - a** Unplug the 12v adaptor attached to the side of the EagleEye Director.
  - b** Wait a 5 seconds.
  - c** Plug the 12v adaptor into the side of the EagleEye Director.

It could take up to two minutes for the EagleEye Director to restart.
- 3** Remove the USB storage device.

A log file using the name format of `rabbiteye_info_XXXXX.tar.gz` is generated on the USB storage device.



---



# Troubleshooting

For more troubleshooting information, you can search the Knowledge Base at [support.polycom.com](http://support.polycom.com).

## Placing a Test Call

When you finish configuring the system, you can use one of the sample numbers in the directory to test your setup.

### To place a test call using the local or web interface:

- 1 Do one of the following:
  - On the home screen, select  **Directory**.
  - In the web interface, go to **Place a Call > Directory**.
- 2 Select **Sample Sites** and highlight a location.
- 3 Do one of the following:
  - Press  **Call** on the remote control or keypad.
  - Select **Call** in the web interface.



You can remove Sample Sites from the Directory by highlighting the group or individual entries and pressing  **Delete** on the remote control or keypad. You can also choose not to include Sample Sites when you run Software Update.

### To place a test call using the Polycom Touch Control:

- 1 From the Home screen, touch  **Search the Directory** and then touch **Favorites**.
- 2 Touch a location to place a call.

You can also find a list of worldwide numbers that you can use to test your Polycom HDX system at [www.polycom.com/videtest](http://www.polycom.com/videtest).

If you have trouble making video calls:

- Make sure the number you dialed is correct, then try the call again. For example, you may need to dial 9 for an outside line or include a long distance access code or country code.
- To find out if the problem exists in your system, ask the person you were trying to reach to call you instead.
- Find out if the system you are calling has its power turned on and is functioning properly.
- If you can make calls but not receive them, make sure that your system is configured with the correct number.

## Enabling Diagnostic Mode

Diagnostic Mode is a troubleshooting mode that uses H.261 for video and G.711 for audio. It provides administrators with a workaround for interoperability issues that cannot be resolved using other methods. The Diagnostic Mode setting stays in effect until you change it.



Diagnostic Mode disables many system features such as content sharing, far end camera control, AES encryption, and advanced audio and video algorithms. Audio and video quality is degraded in this mode. Use Diagnostic Mode only when calling systems that do not operate properly with these advanced features.

### To enable Diagnostic Mode:

- 1 Do one of the following:
  - In the local interface, go to **System > Admin Settings > Network > Call Preference** (select  if necessary).
  - In the web interface, go to **Admin Settings > Network > Call Preference**.
- 2 Select **Diagnostic Mode**.

## Using the Restore Button on the Polycom HDX System

You can use the hardware restore button on the Polycom HDX system to reset the system in one of these ways:

- Restoring configuration—Restores the configuration, which resets most system settings to default values.



- Factory restore—Completely erases the system and restores it to the software version and default configuration stored in its factory partition. If you follow this procedure while a USB storage device is connected, the system restores from the USB device instead of the system's factory partition.

The restore button is on the front of the Polycom HDX 9000 series system, as shown in the following figure.



The restore button is on the front of the Polycom HDX 8000 series, Polycom HDX 7000 series, and Polycom HDX 4000 systems, as shown in the following figure.



The restore button is on the left side of the Polycom HDX 4500 system, behind a wire mesh screen. First you must remove the screen, as shown in the following figure.



Then you can use a paperclip to press the restore button, as shown in the following figure.

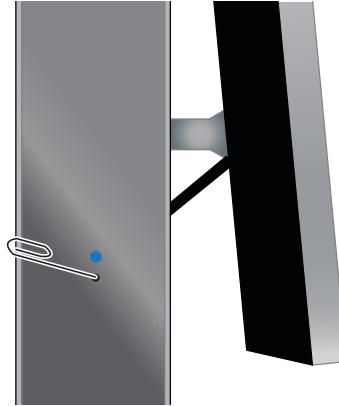

## Restoring Configuration

If the system is not functioning correctly or you have forgotten the Admin Room Password, you can use the restore button to delete system settings and restart the system. This operation is similar to using the Reset System feature on the system Diagnostics screen with **Delete System Settings** enabled.

The following items are saved:

- Current software version
- Option keys
- Remote control channel ID setting
- Directory entries
- CDR data and logs

### **To reset system configuration using the restore button:**

>> While the system is powered on, press and hold the restore button for at least 15 seconds.

After 15 seconds, the system restarts and displays the setup wizard.

## Performing a Factory Restore

If the Polycom HDX system will not start up or develops serious problems after a software update, you can use the restore button to restart the system with its factory partition software. This operation completely erases the system's flash memory and reinstalls the software version and default configuration stored in its factory partition.

The following items are *not* saved:

- Software updates
- All system settings including option keys and the remote control channel ID
- Directory entries
- CDR data



If you follow the procedure to restore the system to factory defaults while a USB storage device is connected, the system restores from the USB device instead of the system's factory partition.

**To reset the system to its factory partition software using the restore button:**

- 1 While the system is powered off, press and hold the restore button.
- 2 While holding the restore button, press the power button once.
- 3 Keep holding the restore button for 5 more seconds, then release it.

During the factory restore process, the system displays the Polycom startup screen on component monitors. Other types of monitors will be blank. Do not power off the system during the factory restore process. The system restarts automatically when the process is complete.

## Deleting Files

You can remove customer data and configuration information from the system for security purposes.

**To perform a logical delete of the system files:**

- 1 Power off the system by holding down the Power button for 3 to 5 seconds.
- 2 Unplug all network connections.
- 3 Perform a factory restore.
- 4 Wait for the system to start up and display the setup wizard.
- 5 While the system is powered on, press and hold the restore button for at least 15 seconds. After 15 seconds, the system restarts and displays the setup wizard.
- 6 Power off the system.

## Performing a Factory Restore on the Polycom Touch Control

If the Polycom Touch Control is not functioning correctly or you have forgotten the Administration password, you can use the restore button to reset the device. This operation completely erases the device's settings and reinstalls the software.

The restore button is on the underside of the Polycom Touch Control, as shown in the following figure.

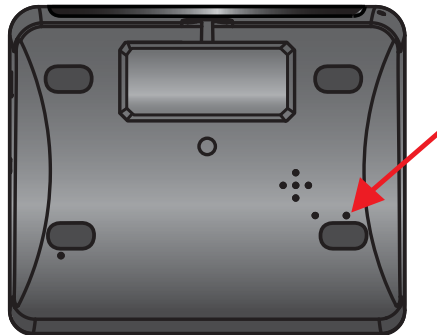

### To reset the Polycom Touch Control using the restore button:

- 1 Power off the Polycom Touch Control.
- 2 Disconnect the LAN cable.
- 3 Disconnect all USB devices.
- 4 Press and hold the factory restore button while you reconnect the LAN cable to the device. Continue to hold the factory restore button down for about 10 seconds after the device powers on.

During the factory restore process, the default platform and applications are reinstalled. Do not power off the device during the factory restore process. The device displays a success message when the process is complete.

## Performing a Factory Restore on the Polycom EagleEye Director

If the Polycom EagleEye Director is not functioning correctly or you need to recover from a corrupted partition, you can use the restore button to reset the device. This operation completely erases the camera settings and reinstalls the software.

The following figure shows you the location of the restore button on the back of the Polycom EagleEye Director.

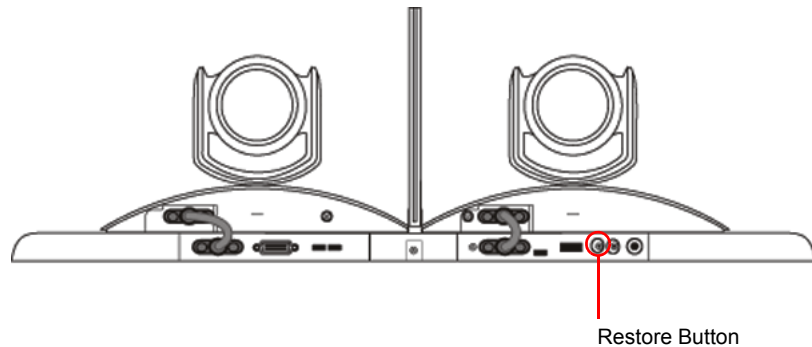

#### To reset the Polycom EagleEye Director using the restore button:



Be sure to keep the Polycom EagleEye Director powered on during the factory restore.





- 1 Press and hold the restore button on the back of the EagleEye Director for 2-3 seconds while the power light cycles.  
When normal video content is displayed on the monitor instead of a blue screen, the EagleEye Director has been successfully restored.
- 2 Release the restore button.

## Changing the Video Format

If you cannot see the user interface on the system's monitor, make sure that the system and the monitor are both powered on, and then do one of the following:

#### To change the video format, do one of the following:

- Go to the Polycom HDX web interface, select **Admin Settings > Monitors**, change the **Video Format**, and click **Update**.

- Press and hold  **Display** on the remote control for 5 seconds. Press  or  to display the new video format in the remote control window, then press  to save your change. If you select a format that is not supported by the system, the default output format is applied.
- From the Polycom Touch Control, touch and hold **Display** on the virtual remote for five seconds. Then touch the desired video format. If you select a format that is not supported by the system, the default output format is applied.

## How to Contact Technical Support

If you are not able to make test calls successfully and you have verified that the equipment is installed and set up correctly, contact your Polycom distributor or Polycom Technical Support.

To contact Polycom Technical Support, go to [support.polycom.com](http://support.polycom.com).

Enter the following information, then ask a question or describe the problem. This information helps us to respond faster to your issue:

- The 14-digit serial number from the **System Information** screen or the back of the system
- The software version from the **System Information** screen
- Information about your network
- Troubleshooting steps you have already tried

## Polycom Solution Support

Polycom Implementation and Maintenance services provide support for Polycom solution components only. Additional services for supported third-party Unified Communications (UC) environments integrated with Polycom solutions are available from Polycom Global Services, and its certified Partners, to help customers successfully design, deploy, optimize, and manage Polycom visual communication within their third-party UC environments. UC Professional Services for Microsoft Integration is mandatory for Polycom Conferencing for Microsoft Outlook and Microsoft Office Communications Server or Microsoft Lync Server integrations. For additional information and details please refer to [http://www.polycom.com/services/professional\\_services/index.html](http://www.polycom.com/services/professional_services/index.html) or contact your local Polycom representative.

## System Back Panel Views

### Video Inputs and Outputs

#### Polycom HDX 9006

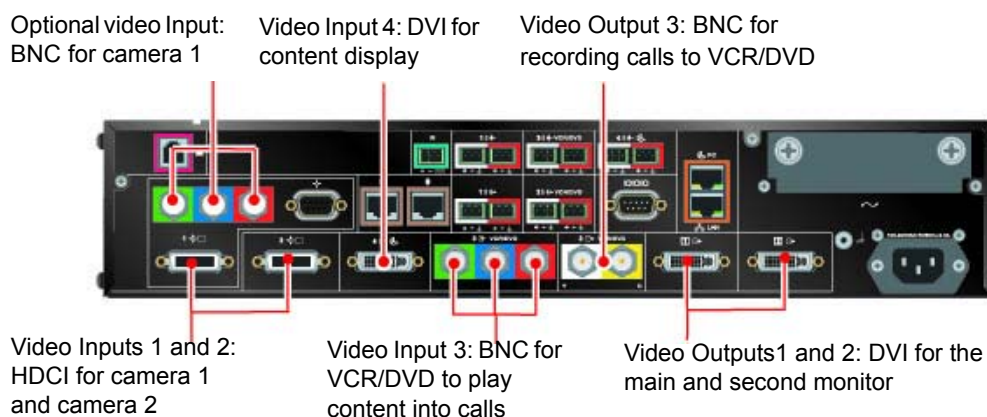

## Polycom HDX 9004

Video Output 1:  
BNC and DVI for  
the main monitor

Video Output 2:  
BNC and DVI for the  
second monitor

Video Output 3: BNC  
for recording calls to  
VCR/DVD

Video Output 4: DVI  
for content display

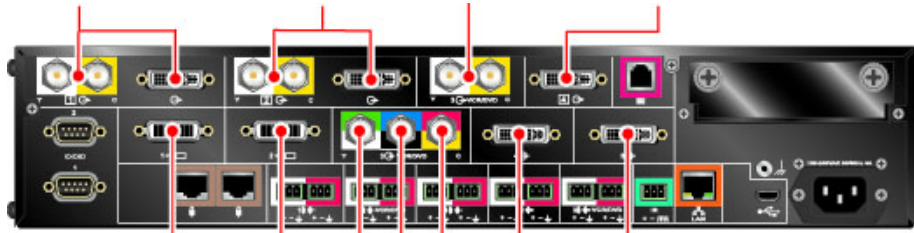

Video Inputs 1 and 2:  
HDCI for camera 1  
and camera 2

Video Input 3: BNC for  
VCR/DVD to play  
content into calls

Video Inputs 4 and 5: DVI  
for playing content from a  
computer into calls

## Polycom HDX 9001 and Polycom HDX 9002

Video Output 1: BNC and  
DVI for the main monitor

Video Output 2: BNC and  
DVI for the second monitor

Video Output 3: BNC for  
recording calls to VCR/DVD

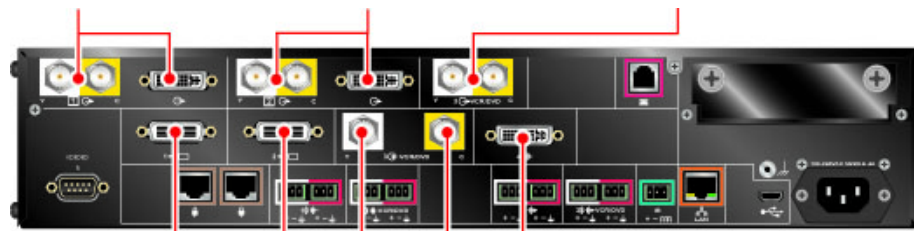

Video Inputs 1 and 2:  
HDCI for camera 1 and  
camera 2

Video Input 3: BNC for  
VCR/DVD to play content  
into calls

Video Input 4: DVI for  
playing content from a  
computer into calls



## Polycom HDX 8000 Series System

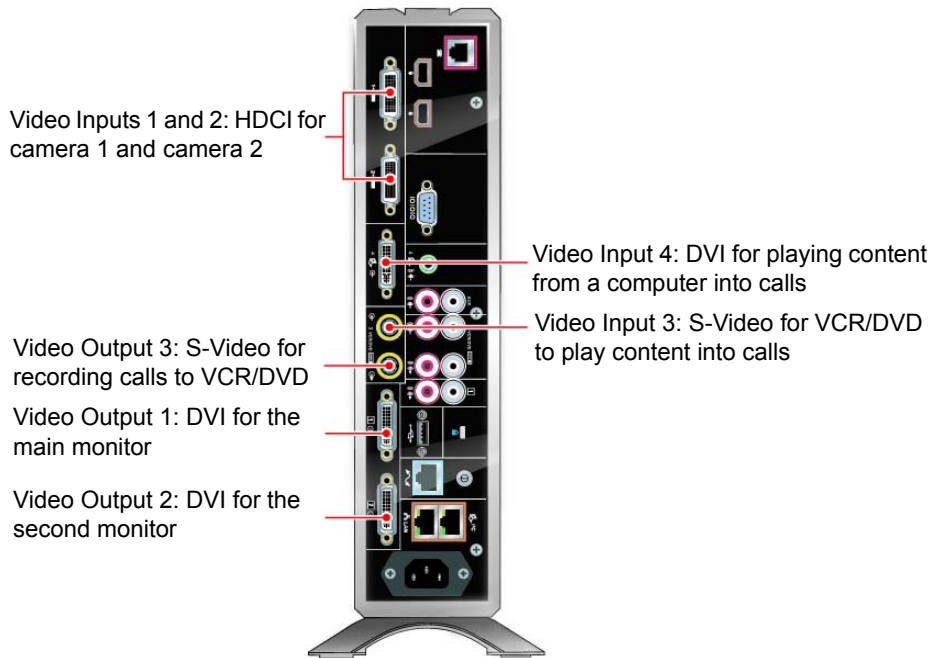

## Polycom HDX 7000 Series System (Hardware Versions A, B, C)

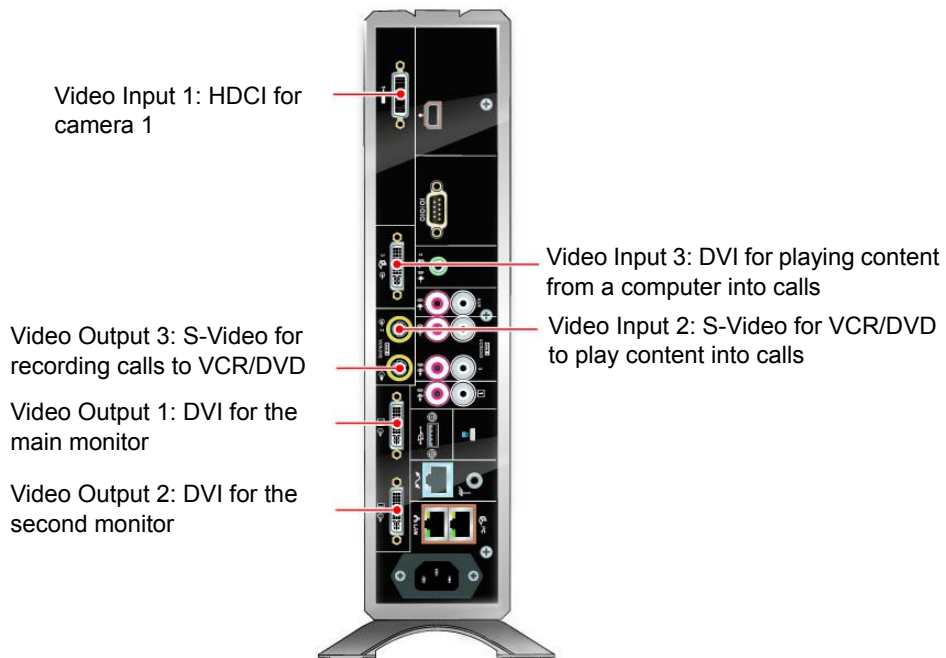

## Polycom HDX 7000 System with Hardware Version D

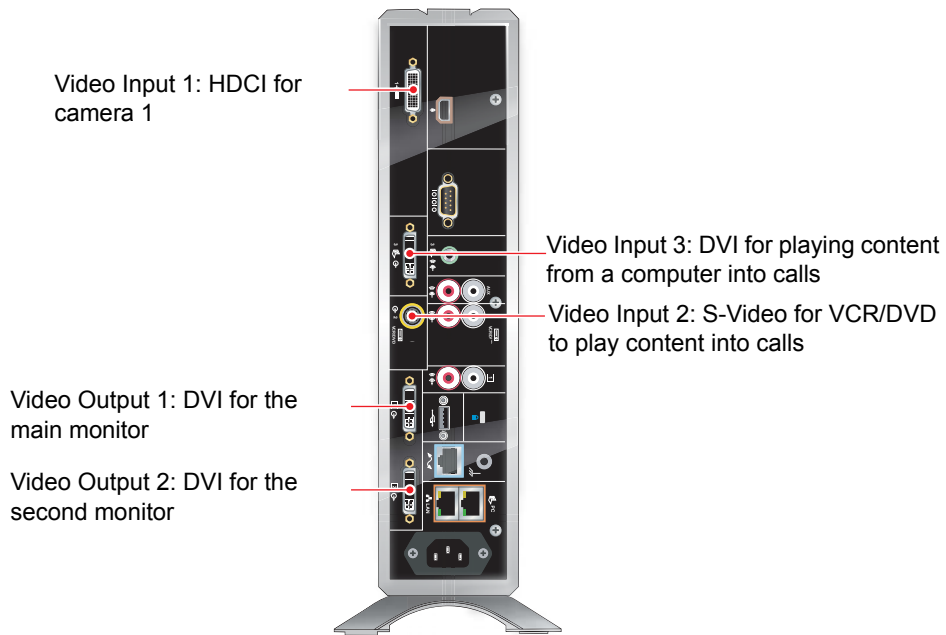

## Polycom HDX 6000 Series System

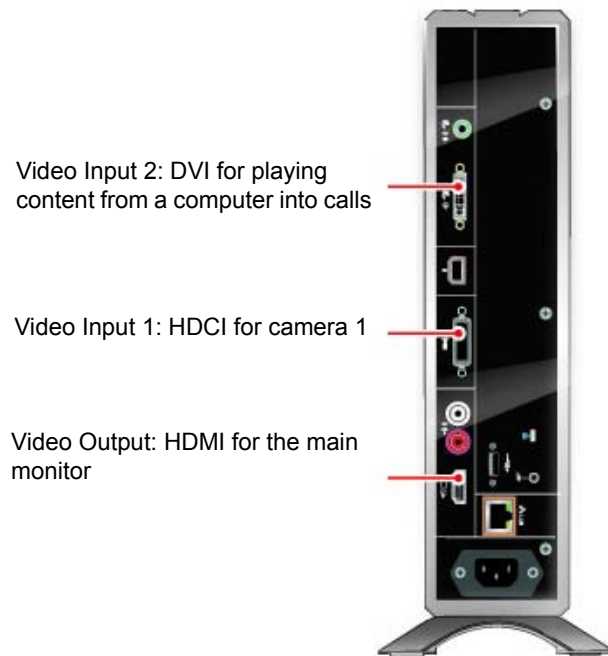

## Polycom HDX 4000 and Polycom HDX 4000 HD Systems

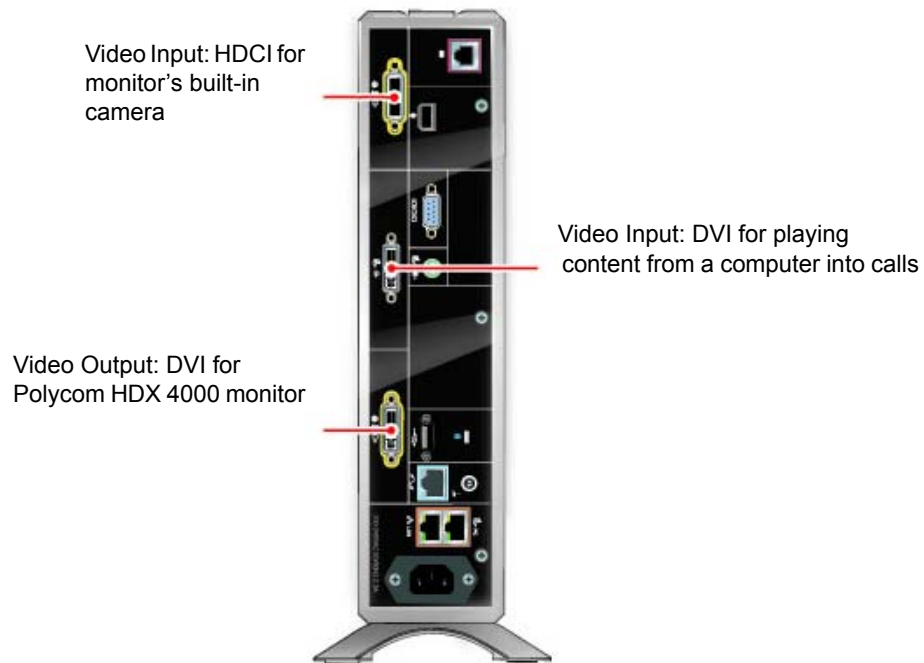

## Polycom HDX 4500 System

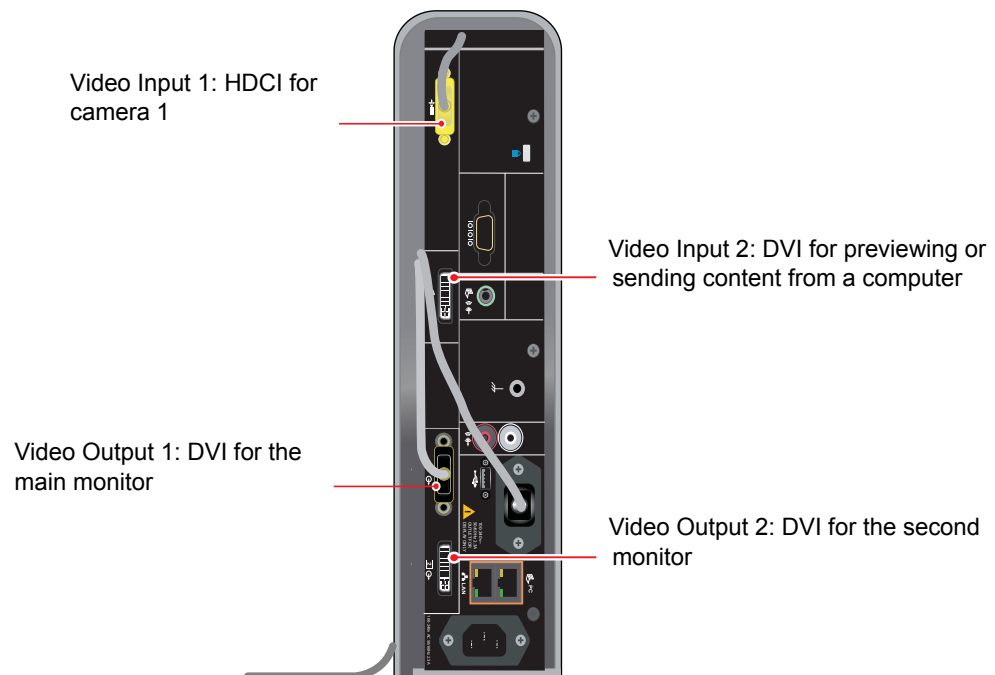

## Audio Inputs and Outputs

### Polycom HDX 9006

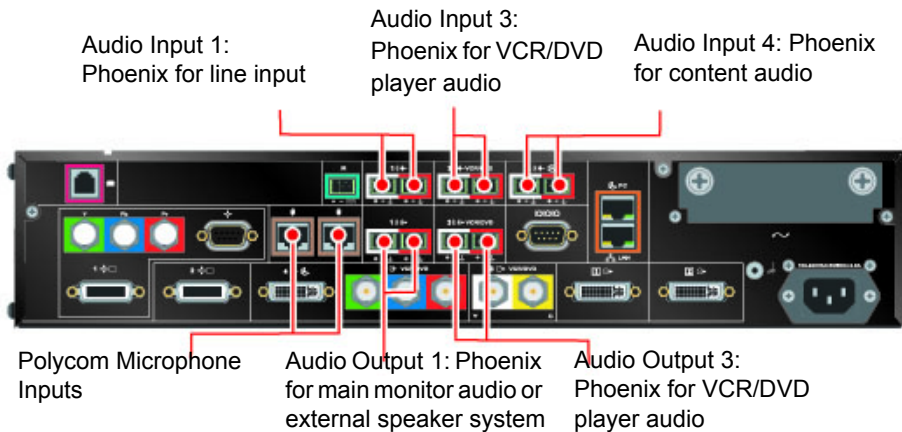

### Polycom HDX 9004

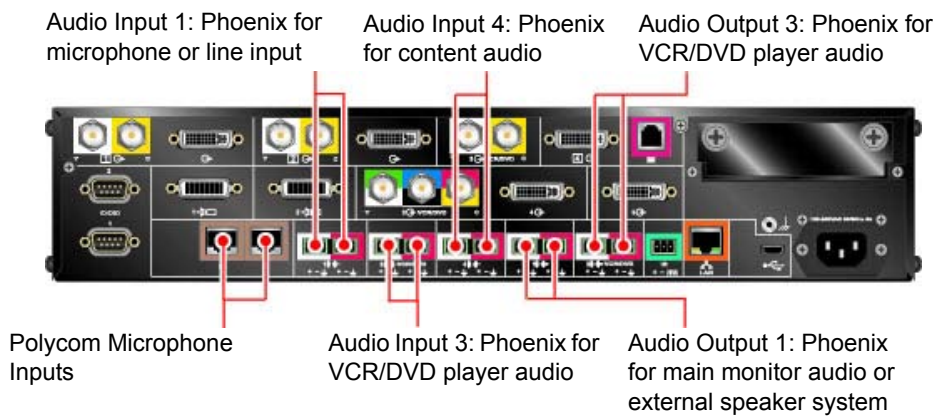

## Polycom HDX 9001 and Polycom HDX 9002

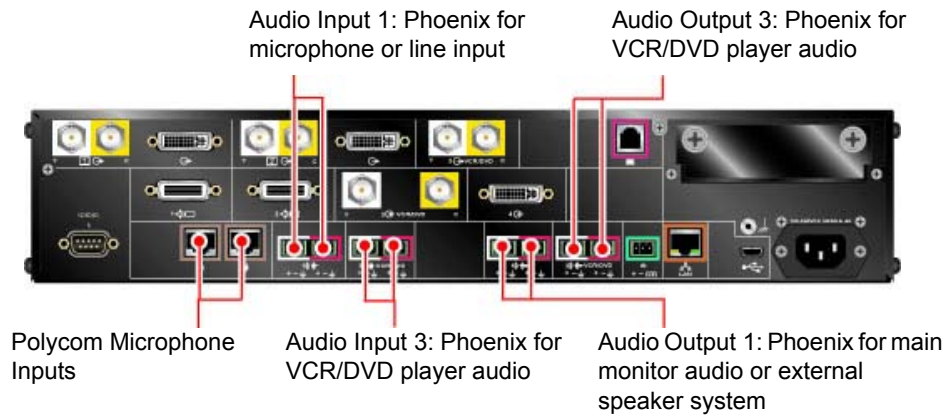

## Polycom HDX 8000 Series System

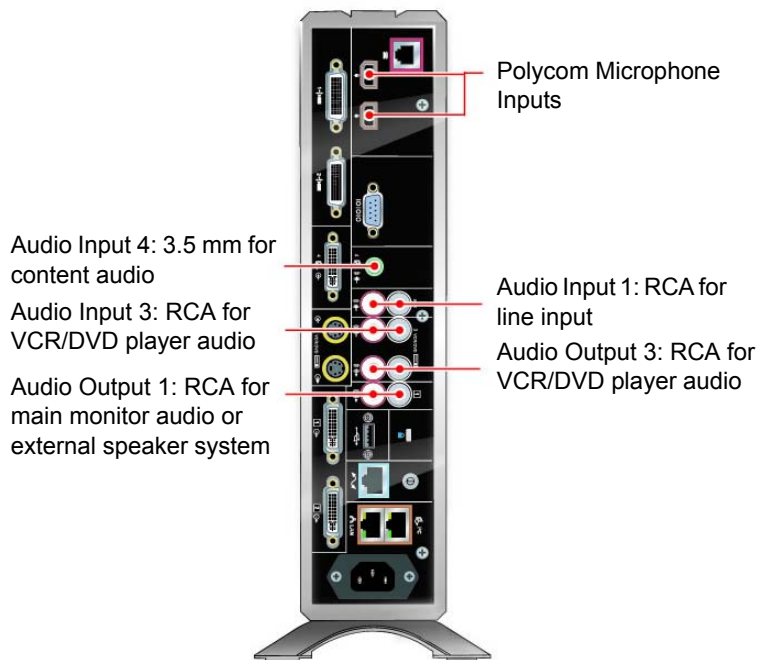

## Polycom HDX 7000 Series System (Hardware Versions A, B, C)

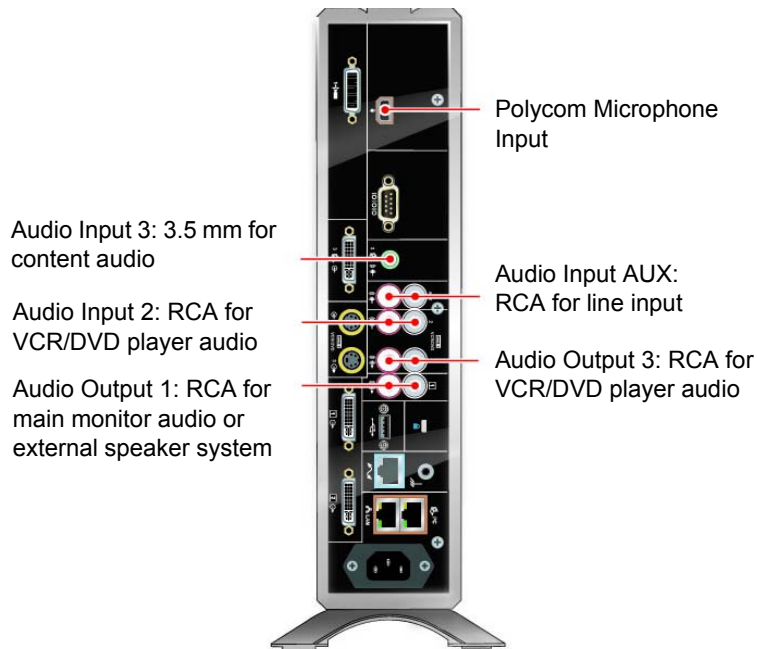

## Polycom HDX 7000 System with Hardware Version D

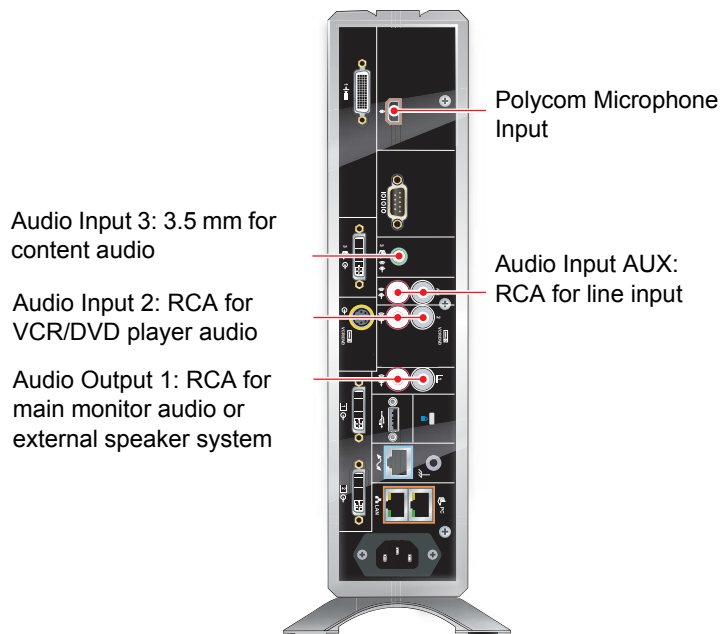

## Polycom HDX 6000 Series System

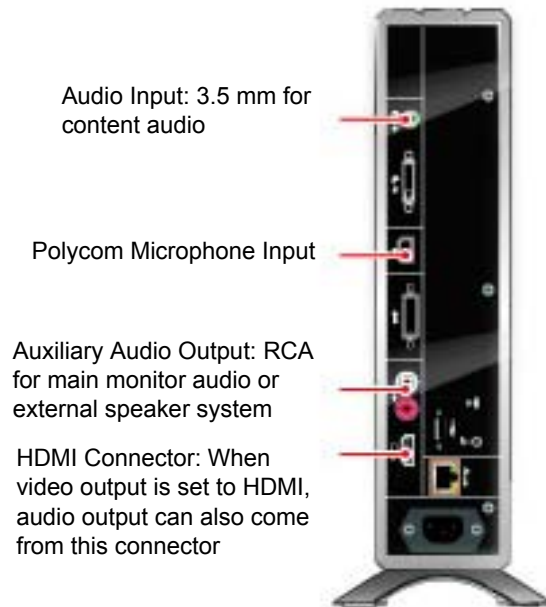

## Polycom HDX 4000 and Polycom HDX 4000 HD Systems

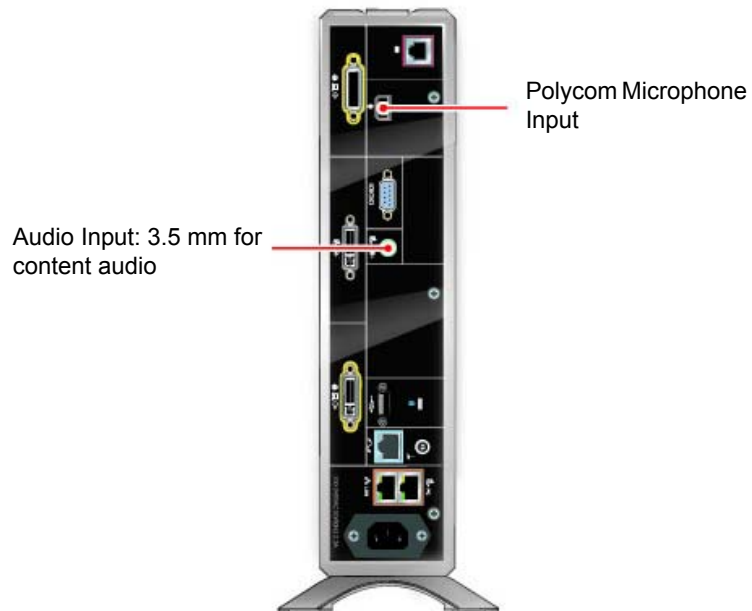

## Polycom HDX 4500 System

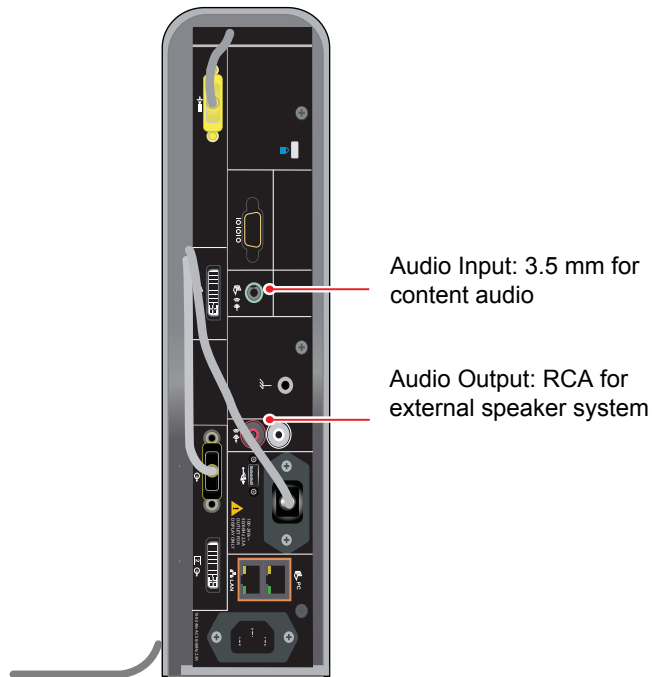

## Network/Power/Control Inputs and Outputs

### Polycom HDX 9006

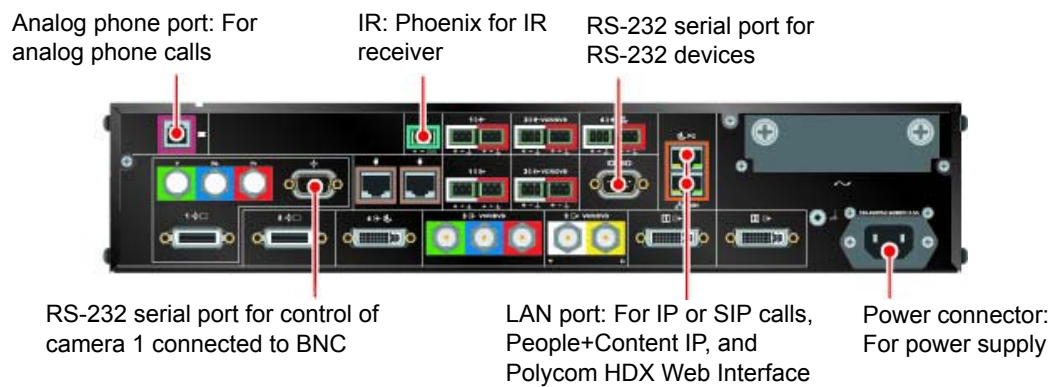



## Polycom HDX 9004

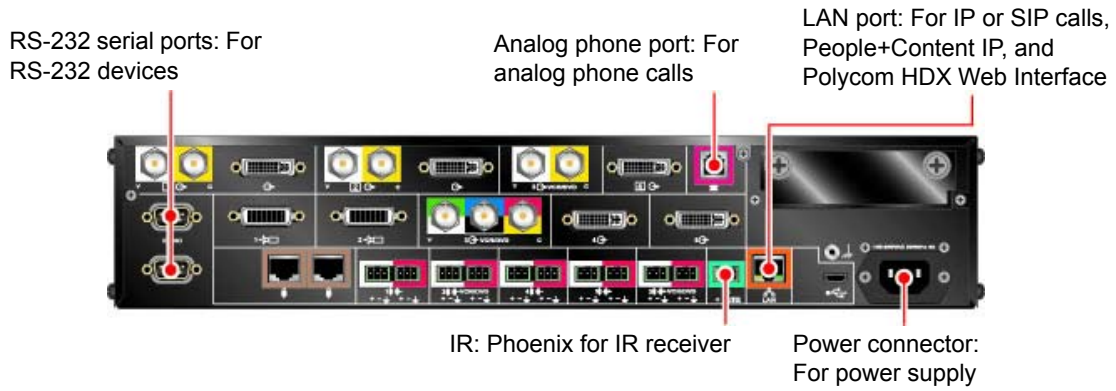

## Polycom HDX 9001 and Polycom HDX 9002

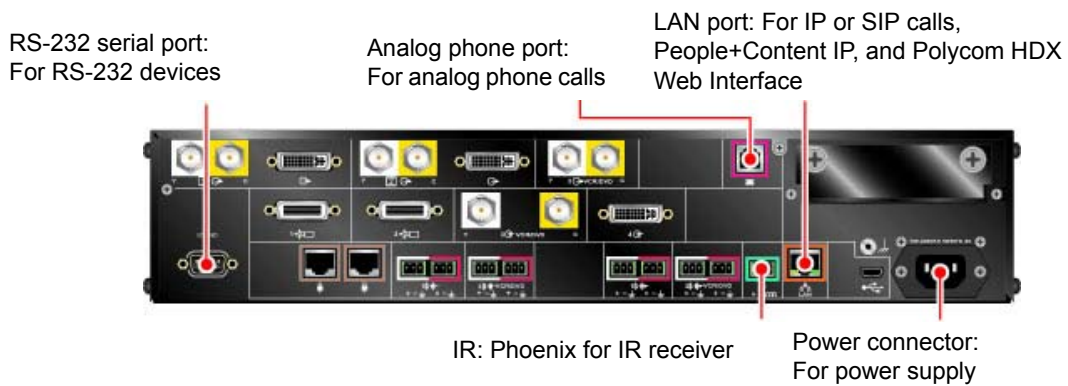

## Polycom HDX 8000 Series System

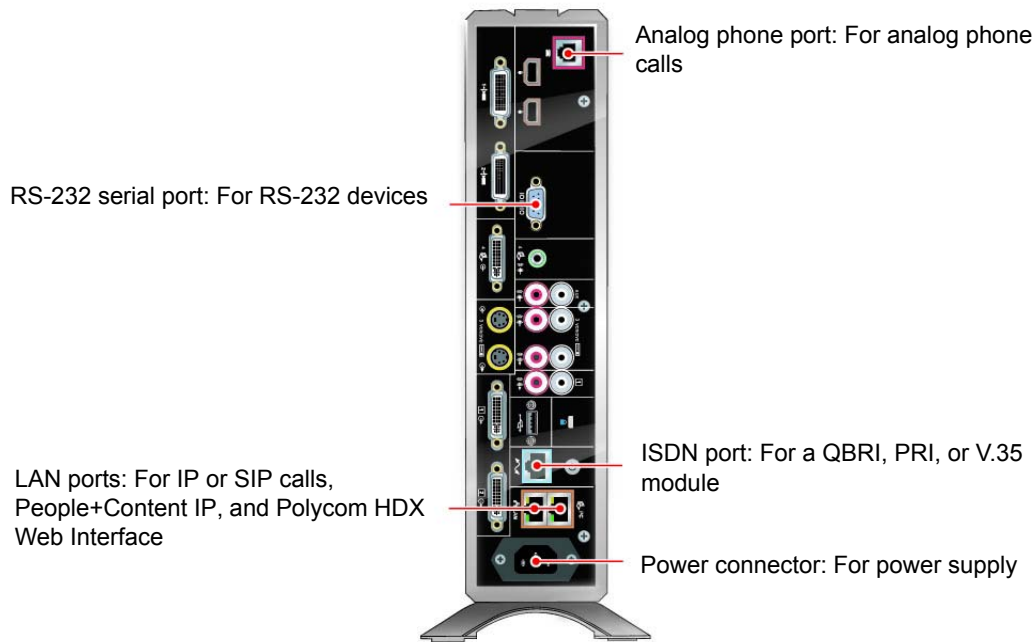

## Polycom HDX 7000 Series System (Hardware Versions A, B, C)

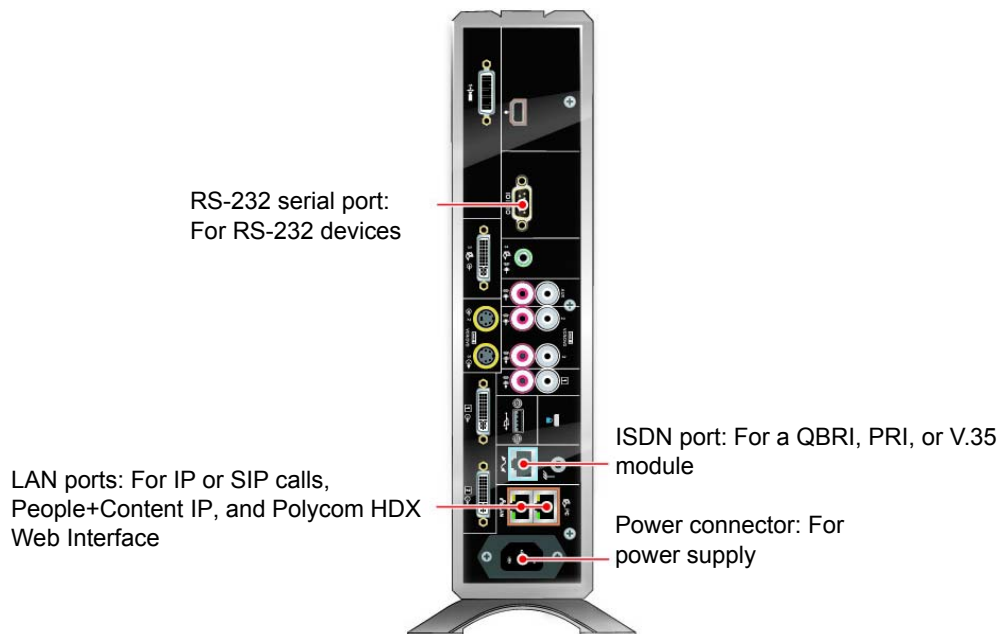

## Polycom HDX 7000 System with Hardware Version D

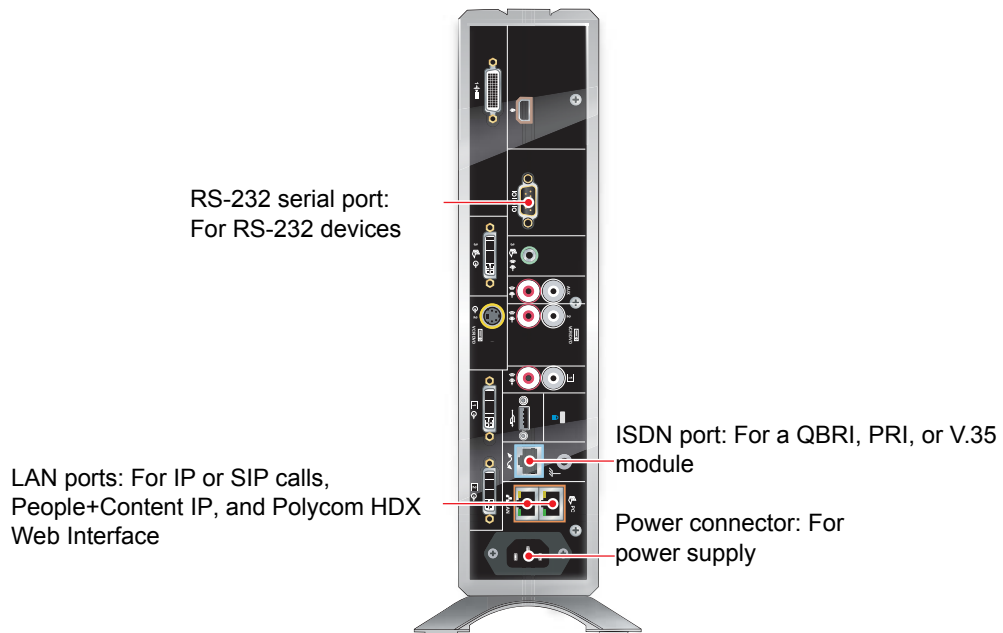

## Polycom HDX 6000 Series System

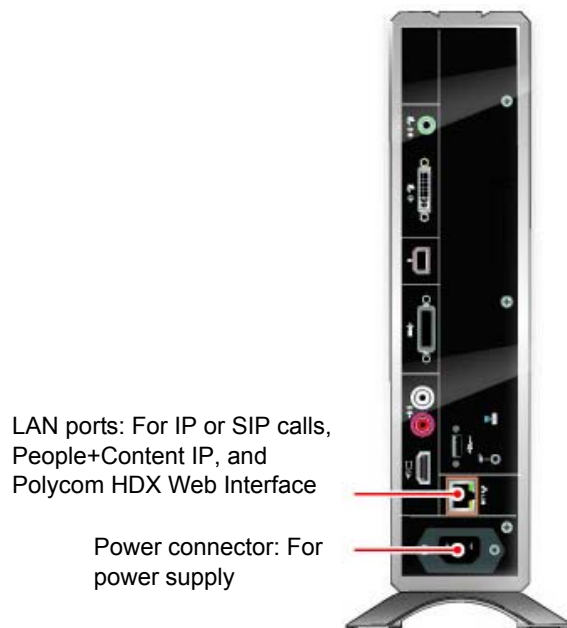

## Polycom HDX 4000 and Polycom HDX 4000 HD Systems

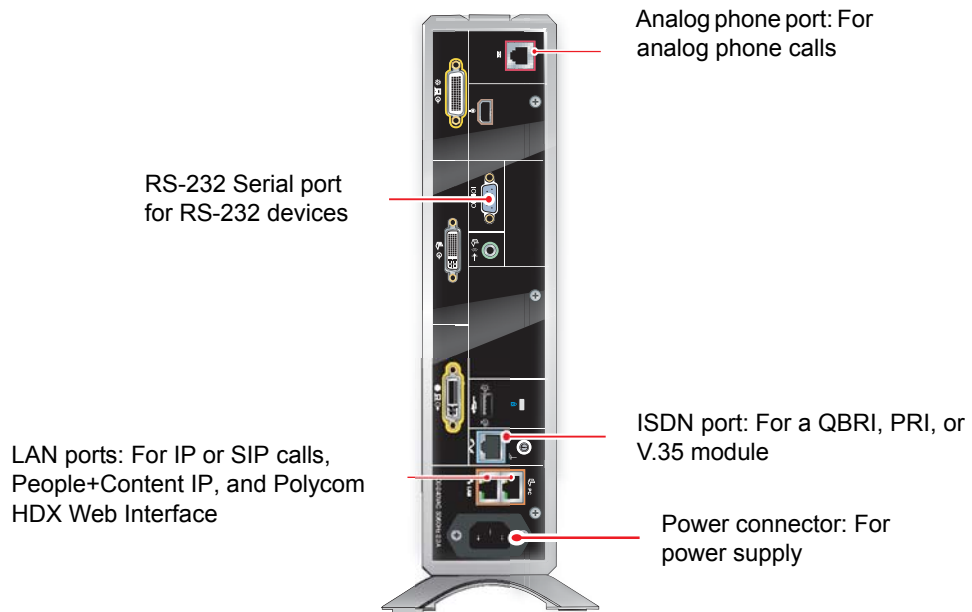

## Polycom HDX 4500 System

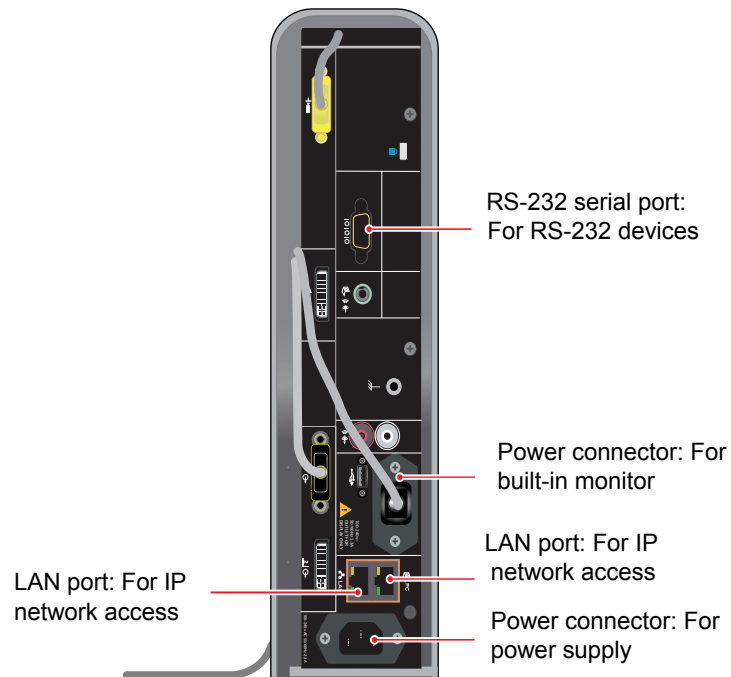

## Port Usage

You might need this information when you configure your network equipment for video conferencing.

The following table shows IP port usage.

Port	Type	Protocol	Function	Configuration		
				On By Default? (Minimum Security Profile)	Location of Setting in Web Interface to Enable or Disable	Configurable Port Number? If Yes, Location of Setting
Inbound Ports (connections to the HDX system)						
23	Static	TCP	Telnet Diagnostics	Yes	Admin Settings/General Settings/Security/Security Settings/Enable Remote Access: Telnet	No
24	Static	TCP	Polycom API	Yes	Admin Settings/General Settings/Security/Security Settings/Enable Remote Access: Telnet	No
80	Static	TCP	HDX Web UI over HTTP	Yes	Admin Settings/General Settings/Security/Security Settings/Enable Remote Access: Web	Admin Settings/General Settings/ Security/Security Settings/Web Access Port
161	Static	UDP	SNMP	No	Admin Settings/Global Services/SNMP/Enable SNMP	No
443	Static	TLS	HDX Web UI over HTTPS	Yes	Admin Settings/General Settings/Security/Security Settings/Enable Remote Access: Web	No
1719	Static	UDP	H.323 Gatekeeper (H.225.0 RAS)	No	Admin Settings/Network/IP Network/H.323 Settings/Use Gatekeeper = Auto, Specify, Specify with PIN	No
1720	Static	TCP	H.323 Calling (H.225.0 Call Signaling)	Yes	Admin Settings/Network/IP Network/H.323 Settings/Enable IP H.323	No
4122	Static	TLS	Polycom Touch Control over TLS	Yes	Admin Settings/Polycom Touch Control/Allow Polycom Touch Control to Pair with this System (Disabled in Maximum Security Security Profile)	No
5001	Static	TCP	People+Content	Yes	Not Configurable (Disabled in Maximum Security Security Profile)	No

Port	Type	Protocol	Function	Configuration		
				On By Default? (Minimum Security Profile)	Location of Setting in Web Interface to Enable or Disable	Configurable Port Number? If Yes, Location of Setting
5060	Static	TCP UDP	SIP (Protocol depends on <b>Transport Protocol</b> setting)	Yes	Admin Settings/Network/IP Network/SIP Settings/Enable SIP	No
5061	Static	TLS	SIP over TLS (dynamically opened only when a Proxy/Registrar Server is configured)	Yes	<ul style="list-style-type: none"> <li>Admin Settings/Network/IP Network/SIP Settings/Enable SIP</li> <li>Admin Settings/Network/IP Network/SIP Settings/Transport Protocol (Auto or TLS)</li> <li>Admin Settings/Network/IP Network/SIP Settings/Registrar Server</li> <li>Admin Settings/Network/IP Network/SIP Settings/Proxy Server</li> </ul>	No
49152 - 65535	Dynamic	TCP	H.323 Control (H.245)	Yes	Admin Settings/Network/IP Network/H.323 Settings/Enable IP H.323	Admin Settings/Network/IP Network/ Firewall/Fixed Ports/TCP Ports (1024-65535)
49152 - 65535	Dynamic	UDP	RTP/RTCP Audio/Video/ Far-end Camera Control	Yes	<ul style="list-style-type: none"> <li>Admin Settings/Network/IP Network/H.323 Settings/Enable IP H.323</li> <li>Admin Settings/Network/IP Network/SIP Settings/Enable SIP</li> <li>Admin Settings/Cameras/ Cameras:/Far Control of Near Camera</li> </ul>	Admin Settings/Network/IP Network/ Firewall/Fixed Ports/UDP Ports (1024-65535)
Outbound Ports (connections from the HDX system)						
80	Static	TCP	GMS/SE200/CMA/ RealPresence Resource Manager Legacy Management	No	Admin Settings/Global Services/ Management Servers Remove HDX from Management list on GMS/SE200/CMA/ RealPresence Resource Manager system	No
80	Static	TCP	Polycom Product Registration	Yes	Uncheck <b>Register</b> checkbox during OOB setup	No
123	Static	UDP	NTP	Yes	Admin Settings/General Settings/ Date and Time/Time Server	No
162	Static	UDP	SNMP TRAP	No	Admin Settings/Global Services/ SNMP/Enable SNMP	No
389	Static	TLS	LDAP	No	Admin Settings/Global Services/ Directory Services/LDAP	No

Port	Type	Protocol	Function	Configuration		
				On By Default? (Minimum Security Profile)	Location of Setting in Web Interface to Enable or Disable	Configurable Port Number? If Yes, Location of Setting
443	Static	TLS	Resource Management (Provisioning, Monitoring, Software Update)	No	Admin Settings/Global Services/Provisioning Service	No
443	Static	TLS	Microsoft Exchange Server (Calendaring)	No	Admin Settings/Global Services/Calendaring Service/Enable Calendaring Service	No
443	Static	TLS	Microsoft Lync Address Book	No	Admin Settings/Global Services/Directory Services/Microsoft Lync Server 2010	No
514	Static	UDP	SYSLOG	No	Diagnostics/Remote Logging Enabled	No
1718	Static	UDP	H.323 Gatekeeper Discovery (H.225.0)	No	Admin Settings/Network/IP Network/H.323 Settings/Use Gatekeeper = Auto	No
1719	Static	UDP	H.225.0 RAS	No	Admin Settings/Network/Call Preference/IP Network/H.323 Settings/Use Gatekeeper = Auto, Specify, Specify with PIN	Yes - outgoing port can be specified in the Primary Gatekeeper IP Address field
1720	Static	TCP	H.323 Calling (H.225.0 Call Signaling)	Yes	Admin Settings/Network/IP Network/H.323 Settings/Enable IP H.323	No
3601	Static	TCP	Polycom GDS	No	Admin Settings/Global Services/Directory Servers/Polycom GDS	No
5060	Static	TCP UDP	SIP	Yes	Admin Settings/Network/IP Network/SIP Settings/Enable SIP	Yes - outgoing port can be specified in the dial string (user@domain:port)
5061	Static	TLS	SIP over TLS	Yes	<ul style="list-style-type: none"> <li>Admin Settings/Network/IP Network/SIP Settings/Enable SIP</li> <li>Admin Settings/Network/IP Network/SIP Settings/Transport Protocol (Auto or TLS)</li> </ul>	Yes - outgoing port can be specified in the dial string (user@domain:port)
5222	Static	TCP	Resource Management: XMPP	No	Provisioned by the RealPresence Resource Manager system	No
49152 - 65535	Dynamic	TCP	H.323 Control (H.245)	Yes	Admin Settings/Network/IP Network/H.323 Settings/Enable IP H.323	Admin Settings/Network/IP Network/ Firewall/Fixed Ports/TCP Ports (1024-65535)
49152 - 65535	Dynamic	UDP	RTP/RTCP Audio/Video/ Far-end Camera Control	Yes	<ul style="list-style-type: none"> <li>Admin Settings/Network/IP Network/H.323 Settings/Enable IP H.323</li> <li>Admin Settings/Network/IP Network/SIP Settings/Enable SIP</li> </ul>	Admin Settings/Network/IP Network/ Firewall/Fixed Ports/UDP Ports (1024-65535)





# Call Speeds and Resolutions

## Point-to-Point Dialing Speeds

The following table shows the maximum allowable H.323/SIP point-to-point dialing speeds for each system.

System	Maximum Call Speed
Polycom HDX 9004	4 Mbps
Polycom HDX 9002 Polycom HDX 9001	4 Mbps
Polycom HDX 8000 series Hardware Version A	4 Mbps
Polycom HDX 9006 Polycom HDX 8000 series Hardware Version B	6 Mbps
Polycom HDX 7000 series	<ul style="list-style-type: none"> <li>• Hardware Versions A and B 2 Mbps</li> <li>• Hardware Versions C and D 4 Mbps</li> </ul>
Polycom HDX 6000 series	2 Mbps
Polycom HDX 4000 series	4 Mbps

## Multipoint Dialing Speeds

The following table shows the maximum allowable H.323/SIP dialing speeds for the number of sites in a call, with Transcoding and AES Encryption disabled. Maximum speeds can be further limited by the communications equipment. Multipoint option keys are required for some of the capabilities shown in the table.

The first analog phone or Voice Over ISDN connection does not count toward the number of sites in a call. Additional analog phone or Voice Over ISDN connections, as well as all H.323 audio-only and SIP audio-only connections, do count toward the number of sites in a call.

<b>Number of Sites in Call</b>	<b>Polycom HDX 9004 Max Speed for Each Site in kbps 8 Mbps)</b>	<b>Polycom HDX 9002 Max Speed for Each Site in kbps 4 Mbps)</b>	<b>Polycom HDX 9001 Polycom HDX 8000 series Polycom HDX 7000 series Polycom HDX 4000 series Max Speed for Each Site in kbps 4 Mbps)</b>	<b>Polycom HDX 9006 Polycom HDX 8000 series with Hardware Version B Max Speed for Each Site in kbps 6 Mbps)</b>
3	3072	1920	1920	1920
4	1920	1344	1344	1344
5	1472	N/A	N/A	N/A
6	1024	N/A	N/A	N/A
7	1024	N/A	N/A	N/A
8	1024	N/A	N/A	N/A

The following table shows the maximum allowable PRI dialing speeds for the number of sites in a call.

<b>Number of Sites in a Call</b>	<b>With T1 PRI Lines Max Speed for Each Site in kbps</b>	<b>With E1 PRI Lines Max Speed for Each Site in kbps</b>
2	1472	1920
3	704	960
4	448	640
5	320	448
6	256	384
7	192	320
8	192	256

The following table shows the maximum allowable BRI dialing speeds for the number of sites in a call.

Number of Sites in a Call	With BRI Lines	
	Number of Lines	Max Speed for Each Site in kbps
2	2	256
2	3	384
2	4	512
3	2	128
3	3	192
3	4	256
4	2	64
4	3	128
4	4	128
5	2	64
5	3	64
5	4	128
6	2	N/A
6	3	64
6	4	64
7	2	N/A
7	3	64
7	4	64
8	2	N/A
8	3	N/A
8	4	64

## Call Speeds and Resolutions

The following illustrations show the resolution and frame rate sent in a call, depending on the speed of the call and the Video Quality setting on your system.

The values for sharpness and motion are the same from 2MB to 6MB for systems that support higher call speeds.



The numbers shown in this section are for NTSC values, but PAL values are similar – for example, 2SIF 352x480 for NTSC relates to 2CIF 352x576 for PAL.

### SD Systems (NTSC)

The following illustration shows the resolutions for People video on these Polycom HDX systems (NTSC):

- Polycom HDX 9001
- Polycom HDX 7000
- Polycom HDX 4000

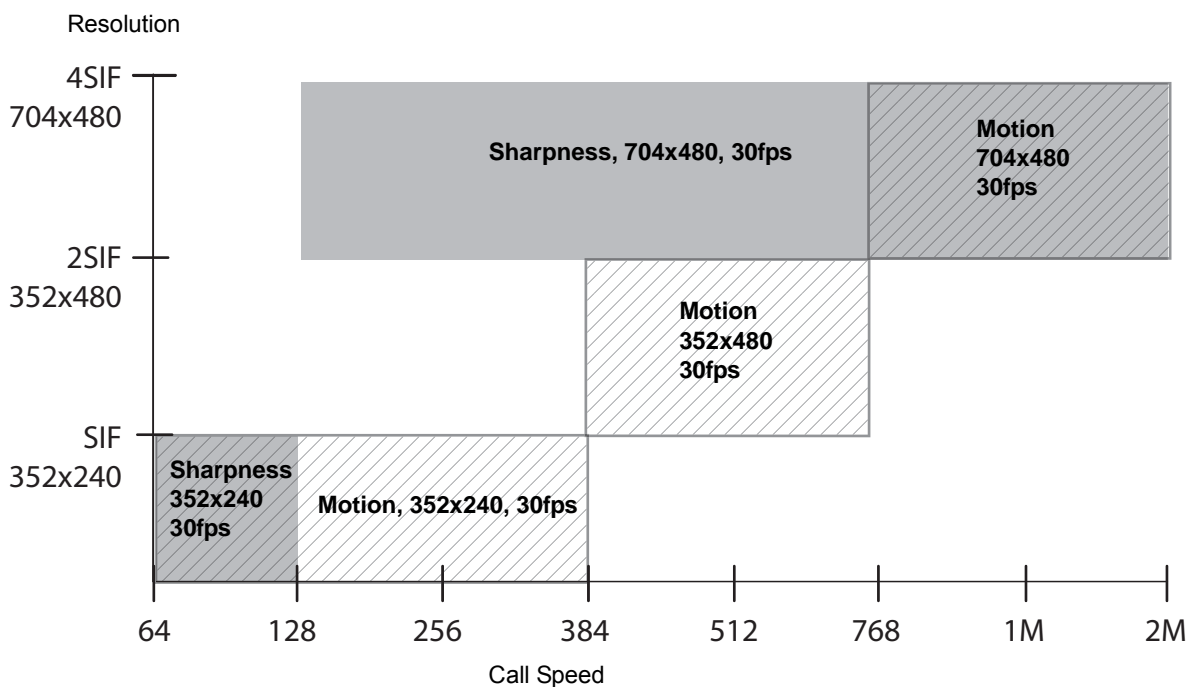

## HD 720p Systems (NTSC)

The following illustration shows the resolutions for People video on these Polycom HDX systems (NTSC):

- Polycom HDX 9004
- Polycom HDX 9002
- Polycom HDX 8000 series with Hardware Version A
- Polycom HDX 7000 HD with Hardware Version A or B
- Polycom HDX 6000 HD
- Polycom HDX 4000 HD

This illustration does not cover scenarios that involve High Profile or the 1080p Resolution option.

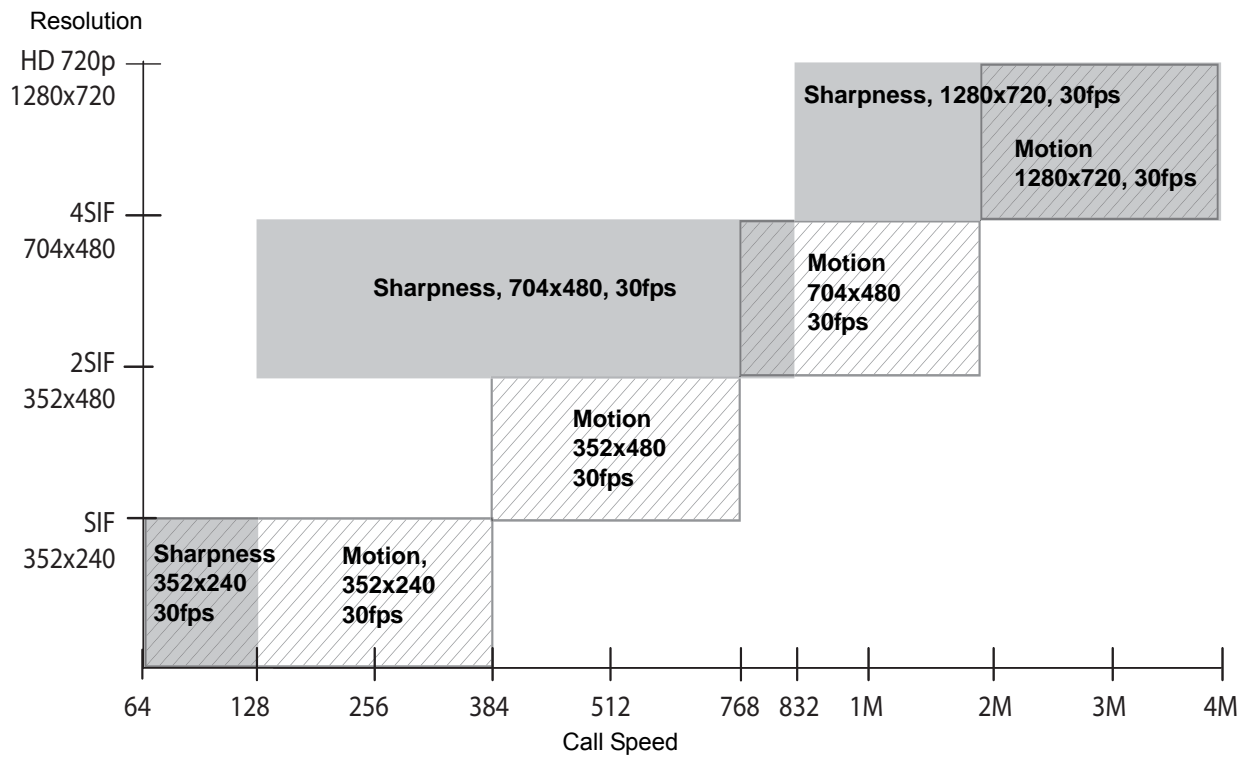

The maximum frame rate for Content is 30 fps for 720p.

## HD 1080p Systems (NTSC)

The following illustration shows the resolutions for People video on these Polycom HDX systems (NTSC):

- Polycom HDX 9006
- Polycom HDX 8000 series systems with Hardware Version B
- Polycom HDX 7000 series systems with Hardware Version C or D

This illustration does not cover scenarios that involve High Profile.

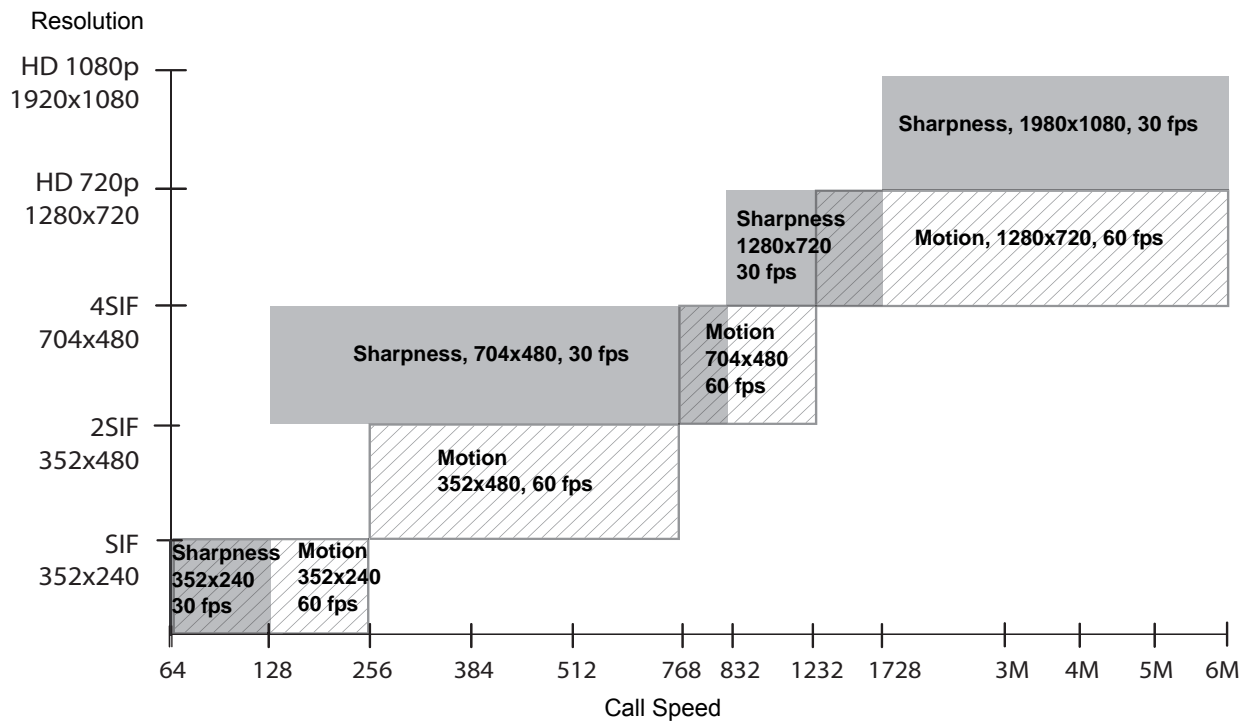

The maximum frame rate for Content is 15 fps for 1080p. You must set Video Quality to **Sharpness**.

## H.264 High Profile

H.264 High Profile video encoding and decoding provides improved resolution in point-to-point H.323 or SIP calls between any of the following systems:

- Polycom HDX 9006
- Polycom HDX 8000 HD with Hardware Version B
- Polycom HDX 7000 HD with Hardware Version C or D
- Polycom HDX 6000 HD
- Polycom HDX 4500
- Polycom HDX 4000 HD with Hardware Version C

The following sections illustrate the available resolutions for the Polycom HDX 9006, Polycom HDX 8000 HD, Polycom HDX 7000 HD, Polycom HDX 6000 HD, Polycom HDX 4500, and Polycom HDX 4000 HD and systems.

### High Profile on Polycom HDX 6000 HD

The following illustration shows the resolutions based on call speed for High Profile 1080p People video on Polycom HDX 6000 HD systems with the 1080p Resolution option key installed.

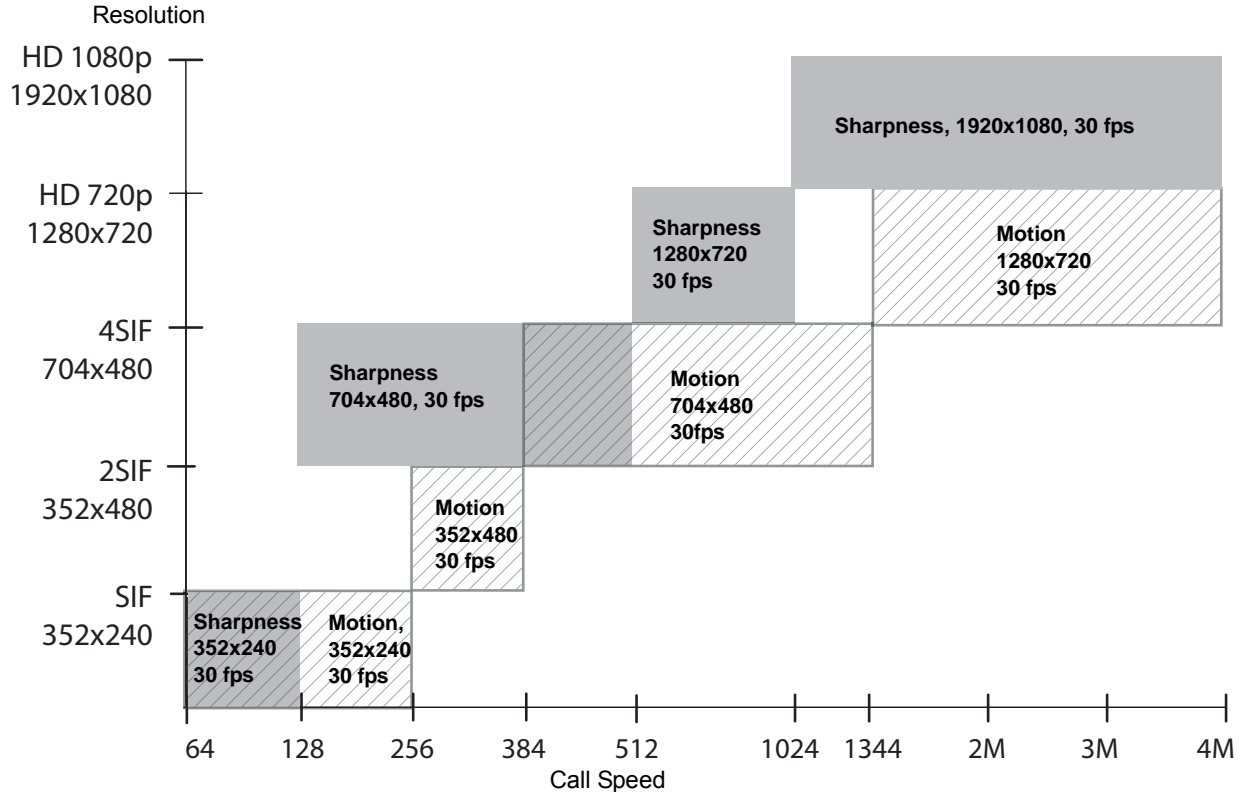

## High Profile on Polycom HDX 4000 HD, Polycom HDX 4500, Polycom HDX 7000 HD, Polycom HDX 8000 HD, and Polycom HDX 9006

The following illustration shows the resolutions based on call speed for High Profile and High Profile over ISDN 1080p people video on these Polycom HDX systems (NTSC) with the 1080p Resolution option key installed:

- Polycom HDX 9006
- Polycom HDX 8000 HD with Hardware Version B
- Polycom HDX 7000 HD with Hardware Version C or D
- Polycom HDX 4500 (ISDN is not supported)
- Polycom HDX 4000 HD with Hardware Version C

The exception is that ISDN calls are supported only for call speeds lower than 2 Mbps.

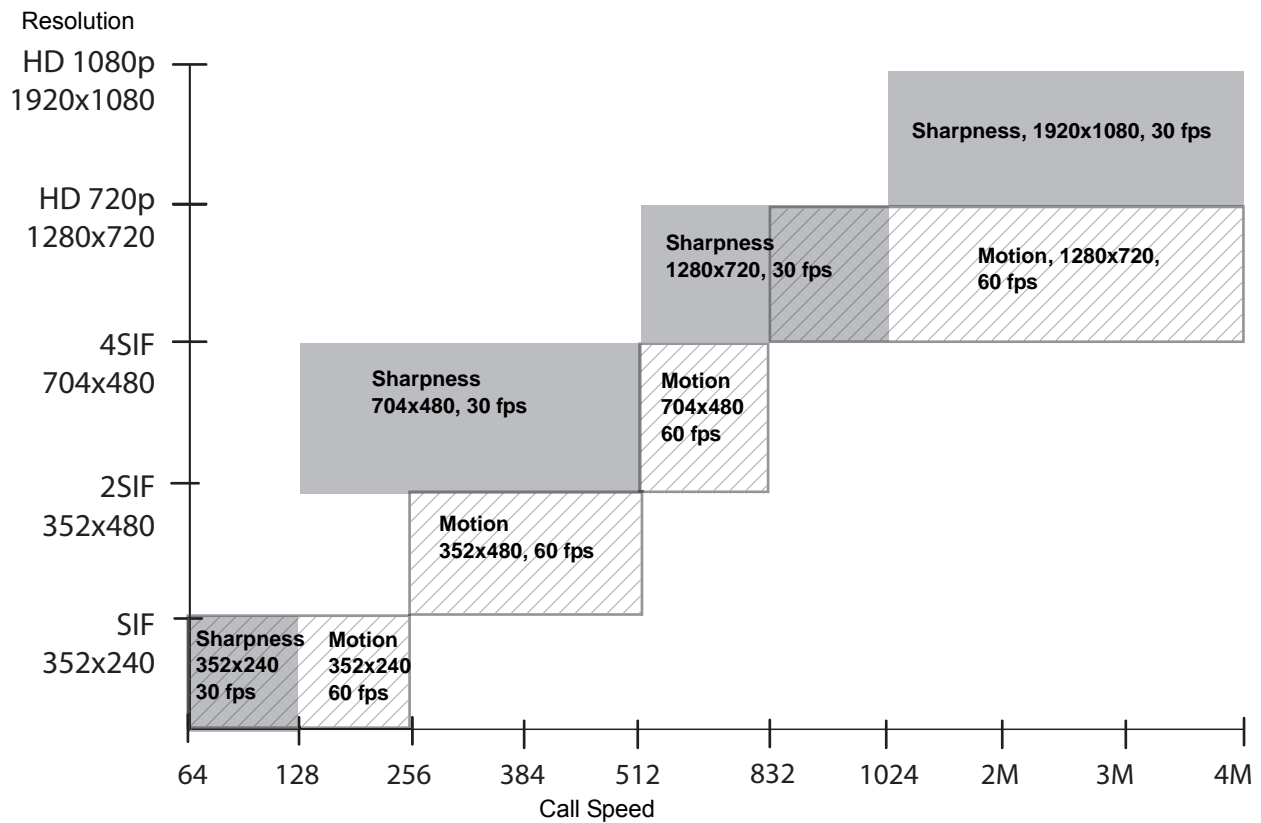

Note that H.264 High Profile over ISDN is **not** supported in V.35 broadcast mode.



## Maximum Resolution (720p) on Polycom HDX 7000 Systems

The following illustration shows the resolutions based on call speed for People video on Polycom HDX 7000 systems with **Maximum Resolution** enabled (NTSC).

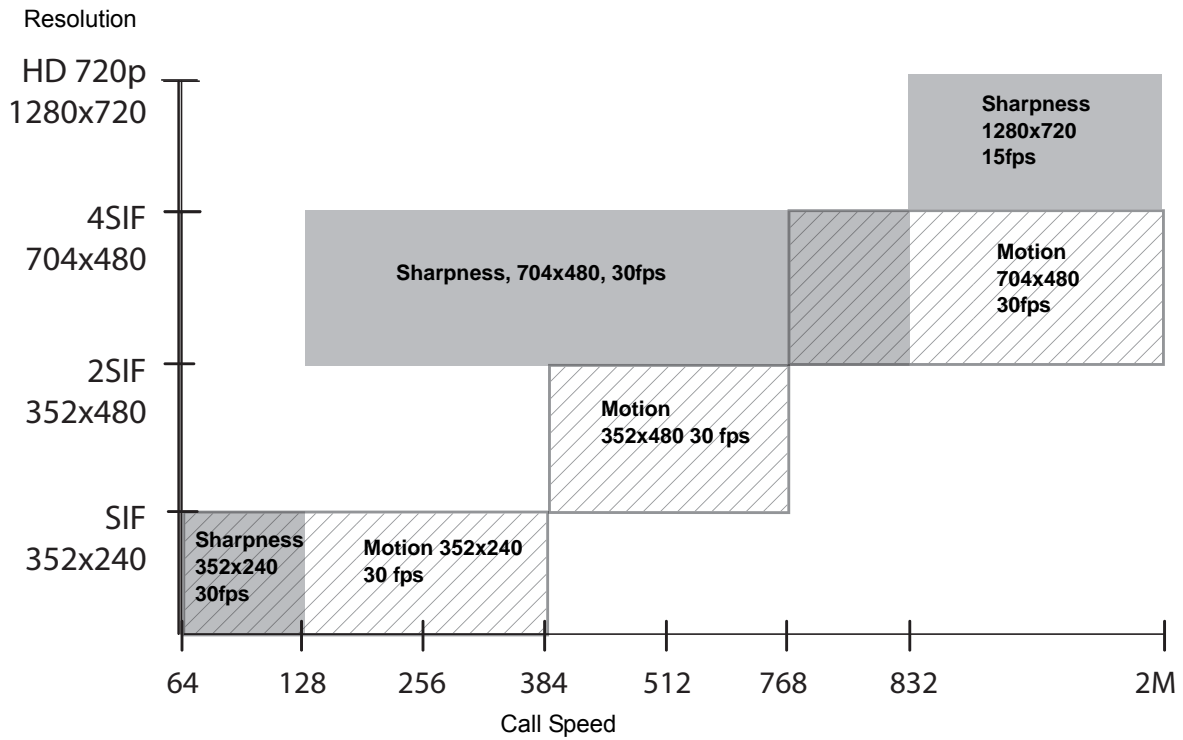

## Maximum Resolution (1080p) on Polycom HDX 6000 Systems

The following illustration shows the resolutions based on call speed for People video on Polycom HDX 6000 HD systems with the 1080p Resolution option key installed and **Maximum Resolution** enabled (NTSC).

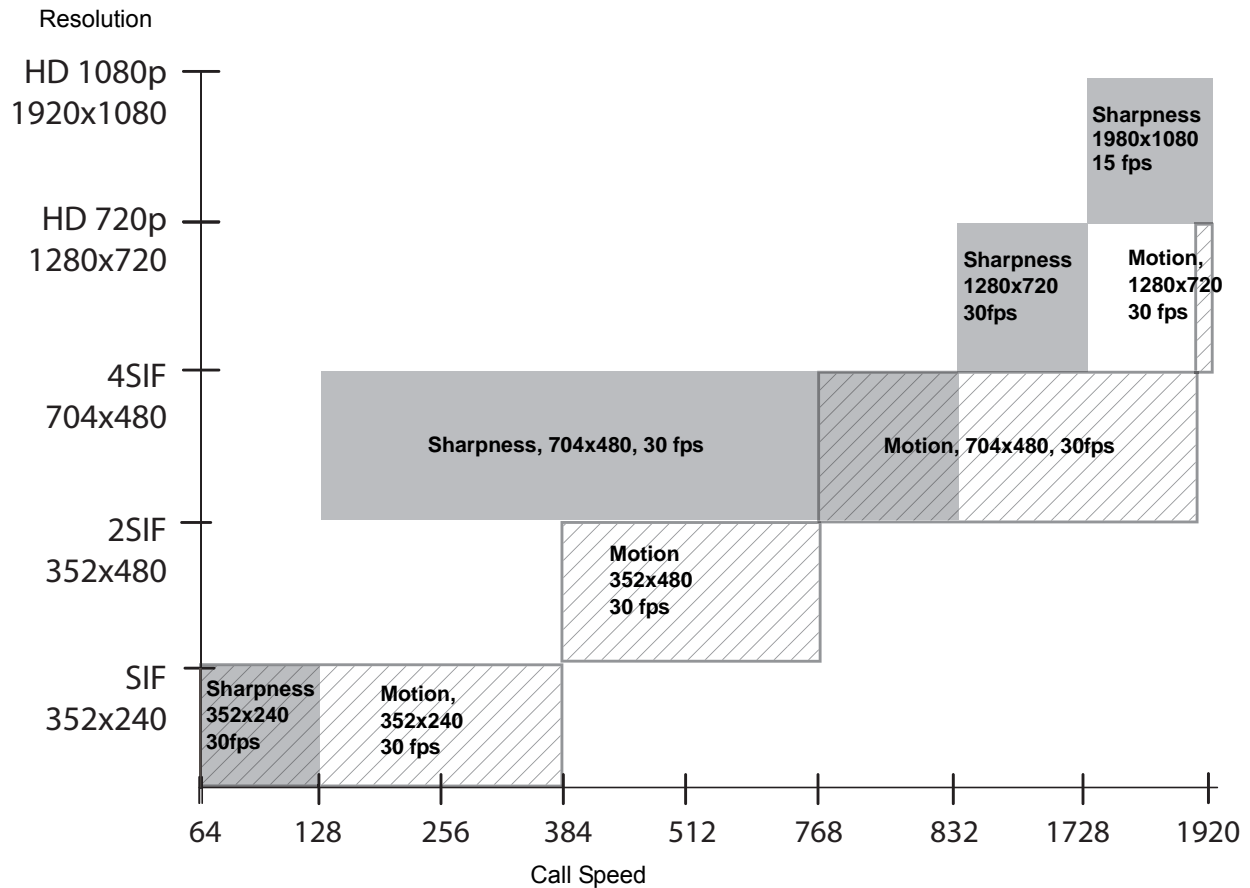

## Resolution and Frame Rates for Content Video

The high frame rates with high resolution apply only to point-to-point calls above 832 kbps on the following systems with software version 2.6 or later.

- Polycom HDX 9006
- Polycom HDX 8000 HD with Hardware Version B
- Polycom HDX 7000 HD with Hardware Version C or D
- Polycom HDX 4500
- Polycom HDX 4000 with Hardware Version C

In addition, you must set Video Quality to **Sharpness**. Low frame rates apply if your call does not meet these requirements.

**Polycom HDX 9006, Polycom HDX 8000 HD with Hardware Version B, Polycom HDX 7000 with Hardware Version C or D, Polycom HDX 4500, Polycom HDX 4000 with Hardware Version C Systems**

Resolution	Low Frame Rate (fps)	High Frame Rate (fps)
640 x 480	15	30
800 x 600	10	30
1024 x 768	7	30
1280 x 720	5	30
1280 x 960	7	30
1280 x 1024	3	22
1680 x 1050	5	30
1920 x 1080	1	15

**Polycom HDX 9004, Polycom HDX 9002, and Polycom HDX 9001 Systems**

Resolution	Frame Rate (fps)
640 x 480	15
800 x 600	10
1024 x 768	7
1280 x 720	5
1280 x 1024	3

## Polycom HDX 6000 System

Resolution	Frame Rate (fps)
640 x 480	15
800 x 600	10
1024 x 768	7
1280 x 720	5
1280 x 960	7
1280 x 1024	3
1680 x 1050	5

# D

---

## Codes for Remote Control Recording Device Buttons

The following tables list codes for programming the Polycom remote control to control specific recording devices. For information about how to program these codes into the remote control, refer to [Configuring the Remote to Control a Recording Device](#) on page 10-3.

### DVD Player Codes

Brand	Codes
Bush	1018, 1020, 1021, 1022, 1025, 1026, 1040
Changhong	1014
Daewoo	1031, 1043
Daewoo International	1043
Denon	1000
Dual	1017, 1025, 1026, 1033, 1040
Emerson	1012, 1019
GE	1088
Goldstar	1012, 1027
Grundig	1007, 1017, 1021, 1025, 1044, 1084, 1096
Hitachi	1010, 1021, 1083
Hyundai	1033, 1042
Integra	1014, 1042
JVC	1001, 1008, 1013, 1062, 1070, 1086, 1096

Brand	Codes
Kenwood	1000, 1005
LG	1012, 1027
Loewe	1090, 1096
Magnavox	1001, 1019, 1096
Marantz	1096
Mitsubishi	1002, 1025, 1081
Panasonic	1000, 1045, 1046
Philips	1001, 1019, 1089, 1090, 1091, 1092, 1093, 1094, 1096
Pioneer	1003, 1009, 1016, 1085
RCA	1009, 1088
Samsung	1000, 1010
Sanyo	1021
Schneider	1017, 1032, 1033, 1040, 1096
Shanghai	1018
Sharp	1015, 1028, 1069
Sony	1004, 1010, 1050, 1053, 1054
Tatung	1031
Teac	1009, 1027, 1030
Thomson	1007, 1080, 1088
Toshiba	1001, 1021, 1060, 1086
Yamaha	1000, 1006, 1089, 1096
Zenith	1001, 1012, 1027

## DVD Recorder Codes

Brand	Codes
Hitachi	1083
JVC	1062, 1070
LG	1012, 1027

Brand	Codes
Mitsubishi	1081
Panasonic	1000, 1045, 1046
Philips	1089, 1091, 1092, 1093, 1094
Pioneer	1016, 1085
Samsung	1000, 1010
Sony	1050, 1053, 1054
Toshiba	1086
Zenith	1027

## VCR Device Codes

Brand	Codes
Bush	1097, 1111, 1117, 1119, 1124
Changhong	1109, 1111
Daewoo	1106, 1107, 1112, 1124, 1136, 1140
Denon	1104
Dual	1097, 1103, 1111, 1119
Emerson	1097, 1100, 1101, 1105, 1106, 1113, 1116, 1140, 1153
Firstline	1101, 1105, 1106, 1119, 1136
GoldStar	1101, 1102, 1115, 1138
Grundig	1111, 1115, 1118, 1119, 1160
Hitachi	1097, 1101, 1103, 1104, 1107, 1111, 1116
Jensen	1103
JVC	1103, 1106, 1110, 1111, 1132, 1141
Kenwood	1102, 1103, 1110
LG	1101, 1102, 1104, 1106, 1136, 1138
Loewe	1101, 1111, 1114
Magnavox	1097, 1100, 1111, 1124, 1157, 1158
Marantz	1100, 1102, 1111

<b>Brand</b>	<b>Codes</b>
Mitsubishi	1097, 1103, 1105, 1109, 1110, 1111, 1124, 1129, 1150
NEC	1100, 1101, 1102, 1103, 1109, 1110, 1112, 1143
Panasonic	1100, 1114, 1115, 1161, 1121, 1134, 1139, 1146, 1133
Philips	1097, 1100, 1111, 1115, 1122, 1126, 1128
Pioneer	1104, 1110, 1111, 1114
Qisheng	1159
Quelle	1111
RCA	1097, 1100, 1104, 1109, 1115, 1116, 1118, 1129, 1133, 1159, 1162
Samaung	1106, 1116, 1120
Sanyo	1107, 1108, 1109, 1110, 1112, 1116, 1119, 1149
Schneider	1097, 1101, 1104, 1111, 1116, 1119, 1124
Sharp	1101, 1109, 1129, 1142
Shinco	1097
Sony	1097, 1098, 1099, 1100, 1123, 1137, 1147, 1148, 1151, 1152, 1155, 1164
Supra	1101, 1119
Tandy	1097, 1112
Tchibo	1119
Teac	1097, 1101, 1103, 1124
Telefunken	1103, 1118, 1124
Thomson	1103, 1110, 1118, 1125, 1156, 1159
Toshiba	1103, 1104, 1105, 1106, 1110, 1111, 1120, 1130, 1131, 1132, 1144, 1154, 1164
Yamaha	1102, 1103
Zenith	1097, 1099, 1136, 1153, 1158



## PVR Device Codes

Brand	Codes
ABS	1164
Alienware	1164
CyberPower	1164
Dell	1164
DirecTV	1126
Gateway	1164
Hewlett Packard	1164
Howard Computers	1164
HP	1164
Hughes Network Systems	1126
Humax	1126
Hush	1164
iBUYPOWER	1164
JVC	1141
Linksys	1164
Media Center PC	1164
Microsoft	1164
Mind	1164
Niveus Media	1164
Northgate	1164
Panasonic	1121, 1139
Philips	1122, 1126, 1128
RCA	1162
Reel Multimedia	1163
ReplayTV	1161, 1121
Sonic Blue	1161, 1121
Sony	1123, 1151, 1152, 1155, 1164
Stack9	1164

<b>Brand</b>	<b>Codes</b>
Systemax	1164
Tagar Systems	1164
Thomson	1125, 1156
Tivo	1122, 1123, 1125, 1126, 1127, 1128, 1156
Toshiba	1130, 1132, 1164
Touch	1164
Viewsonic	1164
Voodoo	1164
ZTGroup	1164

---

# Index

## Numerics

802.1p/Q 2-5

802.1X 2-5

## A

access

allowing 7-5, 8-4, 8-5, 8-40

levels 7-3

limiting 1-17, 6-6, 7-3, 8-5

remote 8-4

Account Lock Duration in Minutes (setting)

8-37, 8-38

account lockout 8-37

account number

recorded in CDR 9-5, 11-10

requiring 9-5

restriction for Touch Control 9-5

validating 9-5

Account Validation (screen) 9-5

Acme Packet Net-Net family of Session Border  
Controllers (SBC) 2-25

Active Directory 6-9

Active Directory Admin Group (setting) 8-36

Active Directory Server Address (setting) 8-35

Active Directory User Group (setting) 8-36

adapter, null modem 5-11

Add a Certificate Revocation List (CRL) (setting)  
8-31

adding certificate revocation lists 8-31

adding certificates 8-28

Address Displayed in Global Directory (setting)  
2-24

addresses

directory, displaying 2-24

displaying 7-5

Global Directory Server 6-11

IPv4 2-3

IPv6 2-4

NAT public (WAN) 2-23

primary gatekeeper 2-10

adjusting room view for EagleEye Director 3-31

Admin Account screen 8-37

Admin ID (setting) 8-3

admin role 8-34

Admin Settings 1-17

AES encryption

enabling 8-24

*See also* encryption

AES Encryption (setting) 8-5

alert tones 4-14

alerts 11-2, 11-3

Allow Access to User Settings (setting) 8-5, 8-40

Allow Directory Changes (setting) 6-6

Allow Incomplete Revocation Checks (setting)  
8-31, 8-32

Allow Mixed IP and ISDN Calls (setting) 6-2

Allow Video Display on Web (setting) 8-5, 9-2

Alternate Gatekeepers (setting) 2-12

Always Validate Peer Certificates from Browsers  
explanation 8-30

setting 8-28

Always Validate Peer Certificates from Servers  
explanation 8-31

setting 8-28

AMX or Crestron touch-panel control 10-4

analog content priority 5-5

analog phone 2-35

Analog Phone (setting) 2-38

Answer on DSR (setting) 2-34

answering calls automatically 6-2

Area Code (setting) 2-14, 2-30, 2-31, 2-34

aspect ratio

monitor 1 3-4

monitor 2 3-6

monitor 3 3-7

monitor 4 3-8

audio

autorotation 4-20

configuring equipment type 4-16

- content input meter 4-17
- input formats, connecting 4-1-4-3
- input type meter 4-16
- inputs and outputs A-6
- left and right meters 4-20
- line out meters 4-17
- line-in level 4-17
- line-in level meter 4-18
- line-out level meter 4-18
- meter test 11-7
- meters 4-20
- mixer, connecting 4-9
- non-Polycom microphone meters 4-22
- output formats, connecting 4-11-4-12
- Polycom microphone meters 4-19
- protocol (call statistics) 11-3, 11-4
- sound effects volume 4-14
- stereo setting 4-20
- StereoSurround 4-19
- VCR/DVD settings 5-2, 5-3
- volume 4-18
- Audio Input (settings) 4-15
- Audio Output (settings) 4-15
- Audio Priority (setting) 2-6
- Audio Protocol (setting), for broadcasting 2-35
- Audio Settings (screen) 4-14
- Authentication PIN (setting) 2-11
- Authentication Type (setting) 6-12
- Auto Adjust for Daylight Saving Time (setting) 7-2
- Auto Answer Multipoint Video (setting) 6-2
- Auto Answer Point-to-Point Video (setting) 6-2
- Auto BRI Configuration (setting) 2-30
- Auto mode (multipoint display) 3-11
- Auto NAT Configuration 2-23
- Auto Preferred Dialing Method 2-39
- auto-answer, muting 4-14
- automatic
  - detect SPIDs 2-31
  - get IP address 2-4
  - provisioning 9-10
  - restart, settings that cause 2-3-2-6, 3-29, 7-2, 8-4, 8-5
- automatic provisioning 9-10
- Autorotation (setting) 4-20
- Availability Control (setting) 7-5
- Avaya network integration 2-12

## B

- back panel views A-1, A-6

- Background Content Source (setting) 5-7
- Backlight Compensation (setting) 3-29
- bandwidth
  - allowing users to specify 7-6
  - dynamic 2-22, 3-29
  - managing 2-15, 2-22, 2-41
  - specifying 2-22
  - specifying allocations for People and Content 3-29
  - See also* call speed
- Base DN (Distinguished Name) 6-11
- bass adjustment 4-18
- Baud Rate (setting) 10-5
- black level, setting for Polycom EagleEye 3-34
- Bonding (setting) 2-31
- BRI dialing speeds C-3
- BRI network interface
  - capabilities 2-26
  - channels to dial in parallel 2-30
  - configuring 2-29
  - configuring ISDN 2-29
  - connecting to systems 2-26
  - enabling/disabling lines 2-30
  - hardware requirements 2-26
  - lights 2-28
  - specifying B1 and B2 channel numbers 2-30
  - voice algorithm 2-30
- brightness, setting for Polycom EagleEye 3-34
- broadcast mode, setting up 2-35
- browser, configuring to use Polycom HDX web interface 9-1
- Built-In Microphones (dB meter) 4-17
- burn-in, preventing on monitors 3-13
- buttons to use on the home screen 7-4

## C

- CA, *See* certificates 8-27
- cable connections A-1, A-6
- cables, microphone 4-5, 4-6, 4-7
- Calendar button 6-17, 7-5
- calendar service 6-15
- calibrating the EagleEye Director 3-31
- Call Detail Report (CDR)
  - account numbers 9-5
  - and Global Management System 6-2
  - archives 11-13
  - description 11-9
  - information provided 11-10
- Call Detail Report (screen) 11-10, 11-13
- Call Detail Report (setting) 6-2

- Call Preference (screen) 2-37
- Call Preference (setting) 2-40
- Call Quality (setting) 2-40, 2-41, 7-6
- Call Settings (screen) 6-1
- call speed
  - allowing users to specify 7-6
  - call statistics 11-4
  - information about C-1
  - serial V.35/RS-449/RS-530 2-34
  - setting gateway prefixes/suffixes 2-15
  - setting preferences 2-40, 2-41
  - See also* bandwidth
- Call Speeds (screen) 2-41
- Call Statistics (screen) 11-3
- Call Status (screen) 11-4
- Call Summary (screen) 11-3
- call type
  - allowing users to specify 7-6
  - listed in call statistics 11-4
- Call-by-Call (setting) 2-32
- Calling Profile (setting) 2-34
- calls
  - analog voice-only, enabling 2-38
  - answer mode 6-2
  - auto-answer 6-2
  - basic troubleshooting 12-2
  - cascaded 6-4
  - elapsed time, displaying 7-2
  - gateway 2-41
  - history, *See* Call Detail Report (CDR)
  - ISDN voice-only, enabling 2-39
  - mixed, allowing 6-2
  - muting auto-answer 4-14
  - preferences, configuring 2-37
  - recent 11-9
  - refusing 7-5
  - refusing, *See also* Do Not Disturb
  - test 12-1
  - time, maximum 6-1
  - tracking 9-5
  - type 7-6, 11-4
- Camera 1 (setting) 3-24
- Camera 2 (setting) 3-25
- Camera 3 (setting) 3-26
- Camera 4 (setting) 3-27
- Camera 5 (setting) 3-28
- Camera Control (setting) 10-6
- Camera Pan Direction (setting) 3-29
- camera presets 3-36
- Camera PTZ (setting) 10-5
- cameras
  - backlight compensation 3-29
  - configuring 3-24-3-36
  - connecting 3-14, 3-17, 3-19, 3-20, 3-21, 3-22, 3-23
  - control, configuring 10-5
  - customizing names and icons 3-24, 3-25, 3-26, 3-27, 3-28, 7-7
  - deleting presets 3-36
  - direction of movement, specifying 3-29
  - far control of near camera 3-28
  - input formats 3-17, 3-19, 3-20, 3-21, 3-22, 3-23
  - model descriptions 3-14-3-17
  - positioning 1-4, 1-5
  - primary, specifying 3-29
  - restoring EagleEye settings 3-34
  - setting presets 3-35
  - white balance setting for EagleEye 3-34
- Cameras (screen) 3-24, 3-33
- Can Contain ID or Its Reverse Form ID (setting) 8-25
- cascaded calls 6-5
- certificates
  - add 8-28
  - adding certificate revocation lists 8-31
  - applications disabled in maximum security 8-29
  - certificate authority (CA) 8-27
  - certificate revocation lists (CRLs) 8-31
  - configuring usage 8-28
  - create CSR 8-30
  - deleting 8-32
  - HDX features that require a certificate 8-29
  - management 8-27
  - signing requests (CSRs) 8-29
  - verifying 8-30
- Channel ID (setting) 10-2, 10-3
- channels to dial in parallel 2-30, 2-32
- City or Locality (L) (setting) 8-30
- Clock Source (read-only setting) 2-33
- closed captions
  - configuring the modem 5-11
  - configuring to receive 10-5
  - connecting directly to serial port 5-11
  - connecting with dial-up 5-10
  - providing audio to the captioner 5-9
  - providing by modem 5-10
  - providing using the web interface 5-12
  - RS-232 serial port configuration 5-11
  - ways to provide 5-10
- codes for programming remote control D-1

- color
  - balance adjustment 3-13
  - bar test 3-13, 11-6
  - saturation, setting for Polycom EagleEye 3-34
- Common Name (CN) (setting) 8-30
- computers, connecting to system 5-3
- Conference On Demand
  - configuring systems to use 6-4
  - multipoint calls 2-11
  - notes 2-12
  - restrictions 6-4
- configuring
  - admin settings 1-17
  - AMX or Crestron touch-panel control 10-5
  - analog phone 2-36
  - audio 5-2, 5-3
  - BRI 2-29
  - BRI network interface 2-29
  - call preferences 2-37
  - call settings 6-1
  - camera control 10-5
  - cameras 3-24-3-36
  - closed captioning 5-9
  - content display 5-4
  - directory settings 6-6
  - dual monitor emulation 3-5
  - firewalls 2-22, 2-24
  - for PathNavigator 6-4
  - for VPN 2-23
  - gatekeeper settings 2-10
  - gateway settings 2-15
  - Global Directory 6-9
  - Global Directory Server settings 6-12
  - IP network 2-8-2-24
  - LAN properties 2-3
  - modem for closed captions 5-11
  - monitor settings 3-3
  - monitors
    - color, sharpness, brightness 3-13
    - for dual monitor emulation 3-9
  - multipoint calls 3-11
  - NAT 2-22, 2-23, 2-24
  - network, using the setup wizard 1-17
  - People on Content 5-6
  - PIP 3-5
  - Polycom microphones 4-15
  - Polycom Touch Control 10-6
  - PRI 2-33
  - PRI network interface 2-31
  - remote control 10-1, 10-2
  - RS-232 serial port 10-5
  - signal polarity, serial V.35/RS-449/RS-530 2-34
  - SIP 2-15
  - SNMP 9-7
  - StereoSurround 4-19, 4-20
  - UC Board 5-8
  - VCR/DVD 5-2, 5-3
  - video for recording 3-7
  - video for recording calls 5-3
  - Vortex mixer 4-21, 10-5
- configuring certificate usage 8-28
- configuring People on Content 5-7
- Confirm Directory Additions Upon Call Disconnect (setting) 6-6
- Confirm Directory Deletions (setting) 6-6
- Connect to my LAN (setting) 8-5
- connecting
  - analog phone 2-35
  - cameras 3-17, 3-20, 3-21
  - equipment 10-4
- connectors
  - audio input 4-1-4-3
  - audio output 4-11-4-12
  - back panel A-1, A-6, A-10
  - for sending content 5-5
  - video inputs 3-17, 3-19, 3-20, 3-21, 3-22, 3-23
  - video outputs 3-1, 3-2, 3-3
- Console IP Address (setting) 9-8
- Contact Name (setting) 9-8
- content
  - analog vs digital 5-5
  - display, configuring 3-5, 5-4
  - displaying People on Content 5-6
  - maximum frame rate for 1080p 5-1, C-6
  - maximum frame rate for 720p 5-1, C-5
  - maximum resolution 5-4
  - Polycom Touch Control 5-1
  - sharing through computer 5-3
- Content Input (dB meter) 4-17
- Content Input Level (setting) 4-16
- Content Statistics (screen) 11-4
- Content Video Adjustment (setting) 3-9
- Content video source 3-25, 3-26, 3-27, 3-28
- continuous presence 3-12, 3-39
- control panel 10-4
- Control Priority (setting) 2-6
- Country (C) (setting) 8-30
- Country (setting) 7-2
- Country Code (setting) 2-14
- creating a certificate signing request 8-30
- CRL, *See* certificates 8-31
- Crypto Resync (setting) 2-35

- cryptographic equipment, configuring to use 2-35
- CSR, *See* certificates 8-29
- CSU (channel service unit) 2-32
- CTS signal polarity 2-34
- Current Percent Filled (setting) 8-42
- D**
- D Channel Location (read-only setting) 2-33
- Data Bits (setting) 10-5
- data collaboration, *See* sharing content
- data rates (call statistics) 11-4
- date and time
  - displaying 7-5
  - setting 7-1
- Date Format (setting) 7-2
- daylight saving time adjustment 7-2
- DCD signal polarity 2-34
- Default Gateway (IPv4) (setting) 2-3
- Default Gateway (IPv6) (setting) 2-4
- Delayed DCD Hangup (setting) 2-34
- deleting
  - camera presets 3-36
  - certificates 8-32
  - sample sites 12-1
  - system files 12-5
- destination unreachable messages 2-6
- Detect Camera (setting) 3-25, 3-26, 3-27, 3-28, 10-6
- Detect Cameras (setting) 3-30
- Diagnostic Mode (setting) 2-38
- diagnostic mode, enabling 12-2
- diagnostics screens 11-1
- dialing
  - last number dialed 7-6
  - long distance 7-1
  - order 2-40
  - preferred method 2-39
  - RS-366 2-34
- Dialing Order (setting) 2-41
- dialing prefix
  - ISDN or analog, for outside line 2-36
  - ISDN, for international calls 2-32
  - ISDN, for outside line 2-30, 2-31
  - serial V.35/RS-449/RS-530, for outside line 2-34
- DiffServ 2-21
- digital content priority 5-5
- Direct Inward Dial (setting) 2-14
- directory
  - allowing changes 6-6
  - button 7-4
  - confirm changes 6-6
  - creating localized entry names 6-8
  - downloading to a computer 6-8
  - groups 6-13, 6-14
  - localized entries 6-8
  - managing with Polycom HDX web interface 6-8
  - searching 6-7
  - settings 6-6
  - uploading from a computer 6-8
- Directory (screen) 6-6
- Directory Numbers (setting) 2-30
- disable
  - automatic provisioning 9-10
  - built-in microphone 4-7
  - camera tracking 3-33
  - HDX system user account 8-35
  - ICMP transmission rate limit 2-6
  - IPv6 2-4
  - multipoint trial 6-4
  - PC LAN port 2-6
  - pertaining to Diagnostic Mode 2-38, 12-2
  - port 8-4
  - remote control, using Polycom Touch Control 10-1
  - screen saver feature 3-9
  - security banner 8-6
  - Security Mode 8-9
  - serial port 10-5
  - settings to clear static images 3-14
- Discussion mode (multipoint display) 3-11
- Display Contacts (setting) 6-13
- Display Content (setting) 3-5, 3-6, 3-9
- Display Far Video (setting) 3-5, 3-6
- Display Global Addresses (setting) 6-11
- Display H.323 Extension (setting) 2-9
- Display Icons in a Call (setting) 3-9
- display modes, multipoint 3-11
- Display Name in Global Directory (setting) 6-11
- Display Near Video (setting) 3-5, 3-6
- Display Time in Call (setting) 6-1, 7-2
- displaying PIP 3-5
- displays, *See* monitors
- DNS name
  - Global Directory Server 6-11
  - system 2-4
- DNS Servers (setting) 2-4

- Do Not Allow Previous Passwords (settings) 8-26
- Do Not Disturb (setting) 6-3
- Do Not Disturb control 7-5
- DoD security banner 8-6
- Domain (setting) 6-16, 9-11
- Domain Name (setting) 2-4, 2-18, 6-12
- Domain User Name (setting) 2-17
  - configuring the Office Communications Server pool 6-13
- Download Logs 11-13
- downloading
  - EagleEye Director logs 11-14
  - system logs 11-13
- DSR signal polarity 2-34
- DTMF tones 10-2
- DTR Pulse Duration (setting) 2-34
- DTR signal polarity 2-34
- dual monitor emulation 3-9
- Dual Monitor Emulation (setting) 3-5
- Duplex Mode (setting) 2-5
- DVD/VCR, *See* VCR/DVD
- Dynamic Bandwidth 2-20
- Dynamic Bandwidth (setting) 2-22, 3-29
- dynamic management mode 9-8

## E

- E.164 alias 2-14
- E.164 extension 2-9, 2-10, 2-14
- EagleEye Director
  - adjusting room view 3-31
  - calibrating 3-31
  - diagnostics 11-2
  - downloading logs 11-14
  - factory restore 12-7
  - framing speaker 3-30
  - getting started 3-30
  - indicator light 1-16
  - introduction 3-16
  - lighting issues 3-33
  - positioning 1-7
  - reference audio signal 11-6
  - testing microphone 11-6
  - tracking 3-32
  - troubleshooting detection 3-31
  - voice tracking 3-33
  - waking up 3-25
  - with People on Content 5-6
- EAP 2-5

- echo cancellation, compatibility with Vortex mixer 4-16
- Echo Canceller (setting) 4-16, 4-22
- echo request, response 2-7
- eight-way calls, transmit and receive 3-39
- elapsed time, displaying 6-1, 7-2
- Enable 802.1p/Q (setting) 2-5
- Enable Active Directory Authentication (setting) 8-35
- Enable Broadcast Mode (setting) 2-35
- Enable Built-In Microphones (setting) 4-14
- Enable EAP/802.1X (setting) 2-5
- Enable H.323 Trace (setting) 11-14
- Enable H.460 Firewall Traversal (setting) 2-23
- Enable IP H.323 (setting) 2-37
- Enable ISDN H.320 (setting) 2-30, 2-31, 2-39
- Enable ISDN Trace (setting) 11-14
- Enable Keyboard Noise Reduction (setting) 4-15
- Enable Multipoint Trial (setting) 6-4
- Enable MusicMode (setting) 4-15
- Enable Network Intrusion Detection System (NIDS) (setting) 2-18
- Enable PC LAN Port (setting) 2-6
- Enable People+Content (setting) 2-35
- Enable Phantom Power (setting) 4-16
- Enable Polycom EagleEye View Microphones (setting) 4-15
- Enable Polycom Microphones (setting) 4-15
- Enable Polycom StereoSurround (setting) 4-19
- Enable PVEC (setting) 2-21
- Enable Remote Access (setting) 8-4
- Enable RSVP (setting) 2-21
- Enable Security Banner (setting) 8-6
- Enable SIP (setting) 2-37
- Enable SIP Keep-Alive Messages (setting) 2-24
- Enable SIP Trace (setting) 11-14
- Enable SNMP (setting) 9-8
- Enable V.35/RS-449/RS-530 (setting) 2-33
- enabling
  - automatic provisioning 9-10
  - multipoint trial 6-4
  - People+Content for H.331 broadcasting 2-35
  - sessions list 8-6
- enabling a whitelist 8-33
- enabling external authentication 8-35
- encryption
  - call statistics 11-4
  - enabling 8-5, 8-24



Enter IP Address Manually (setting) 2-3  
 equipment connections 10-4  
 error concealment 2-21  
 extensions  
   E.164 2-9, 2-10, 2-14  
   entering on home screen 7-6  
   H.323 2-9, 2-10, 2-14, 7-6  
 external authentication 8-34  
 External CSU (setting) 2-32  
 external CSU cable length 2-32  
 external IR sensor 10-5  
 external speaker system, *See* speakers

**F**

factory restore  
   EagleEye Director 12-7  
   HDX system 12-2  
   Polycom Touch Control 12-6  
 Far Control of Near Camera (setting) 3-28  
 far site  
   allowing to control near camera 3-28  
   system information (call statistics) 11-4  
 Far Site Name Display Time (setting) 6-2  
 favorites 6-14  
   groups 6-14  
   home screen button 7-4  
   LDAP, by Polycom CMA or RealPresence  
     Resource Manager System 6-15  
   maximum groups 6-14  
   maximum user created 6-13  
   Microsoft 6-15  
   Polycom GDS 6-14  
 favorites, LDAP with H.350 or Active Directory  
   6-14  
 FEC errors (call statistics) 11-4  
 Firewall (screen) 2-23  
 firewall traversal, enabling 2-25  
 firewalls  
   configuring 2-22, 2-24  
   *See also* NAT and security  
 Fixed Ports (setting) 2-23  
 Folder Name (setting) 8-42  
 Foreground Source (setting) 5-7  
 four-way calls, transmit and receive 3-38  
 frame rate  
   call statistics 11-4  
   maximum 1080p content 5-1, C-6  
   maximum 720p content 5-1, C-5  
 Frame Rate (setting), for broadcasting 2-35  
 framing the speaker with EagleEye Director 3-30

Full Screen mode (multipoint display) 3-11

**G**

gatekeeper  
   alternate 2-12  
   IP address 2-10  
   name 2-10  
   specifying 2-10  
 gateway  
   call speed prefix/suffix 2-15  
   calling through 2-41  
   configuring to use 2-15  
   default 2-3  
   specifying number 2-14  
 Gateway Number Type (setting) 2-14  
 Generate Destination Unreachable Messages  
   (setting) 2-6  
 generating DTMF tones 10-2  
 Global Address (setting) 2-4  
 Global Directory  
   configuring 6-9  
   displaying addresses 2-24  
 Global Directory (GDS) (setting) 6-11  
 Global Directory Server  
   allowing system name to be displayed 6-11  
   configuring 6-12  
   copying to local system 6-11  
   displaying 6-11  
   group name 6-11-6-13  
   IPv6 network limitation 2-11  
   localized system names 6-7  
   password 6-11  
   registering to 6-11  
 Global Directory Servers (screen) 6-11  
 Global Management System  
   account number, requiring 9-5  
   CDR records 6-2  
   description 9-4  
   management servers list 9-5  
   network limitation 2-11  
   requesting support from administrator 9-6  
   security mode 8-9  
 Global Responder Address (setting) 8-32  
 Global Services, configuring 9-4  
 Group Name (setting) 6-11, 6-13  
 groups  
   directory 6-13, 6-14  
   favorites 6-14  
 guidelines for using Polycom microphones 4-3

## H

- H.235 Annex D Authentication 2-10
- H.239 (setting) 2-37
- H.239, *See also* sharing content
- H.264 high profile resolutions C-7
- H.320, *See* ISDN
- H.323
  - enabling 2-37
  - extension 2-9, 2-10, 2-14
- H.323 Extension (E.164) (setting) 2-9, 2-10, 2-14, 7-6
- H.323 Name (setting) 2-9, 2-10
- H.323 Settings (screen) 2-11
- H.323, *See also* IP
- H.331, *See* broadcast mode
- Hash Algorithm (setting) 8-30
- HD 1080p system (NTSC) resolutions C-6
- HD 720p system (NTSC) resolutions C-5
- HD multipoint 3-12, C-1
- HD multipoint calls 3-39
- HDX features that require a certificate 8-29
- help
  - contacting technical support 12-8
  - from GMS administrator 9-6
  - solution support 12-8
- high profile (H.264) C-7
- high-definition video
  - network readiness services 2-1
  - receiving 3-37
  - sending 3-37
- home screen
  - button choices 7-4
  - customizing 7-4
  - settings 7-5
- Home Screen Settings (screen) 7-5
- Horizontal Position (setting) 3-28
- Host Name (setting) 2-4
- https protocol for security 8-1

## I

- ICMP Transmission Rate Limit (setting) 2-6
- icons
  - camera 1 3-24
  - camera 2 3-25
  - camera 3 3-26
  - camera 4 3-27
  - camera 5 3-28
  - customizing camera 7-7
  - displaying 3-9

- Identity (setting) 2-5
- Idle Session Timeout in Minutes (setting) 8-34
- Ignore Redirect Messages (setting) 2-6
- Import Directory (utility) 6-8
- IMUX, *See* BRI network interface
- Incoming Video Call (setting) 4-14
- indicator lights, *See* lights
- initial system configuration 1-17
- input formats
  - audio, connecting 4-1-4-3
  - video 3-17, 3-19, 3-20, 3-21, 3-22, 3-23
- Input Type (dB meter) 4-16
- Input Type (setting) 4-16
- inputs
  - audio A-6
  - network A-10
  - video A-1
- installing certificates 8-28
- installing People+Content IP on a computer 5-6
- instructions, on-screen 7-6, 7-8, 9-4
- Interactive Touch Pad RS-232 mode 10-5
- internal CSU, output attenuation 2-32
- International Dialing Prefix (setting) 2-32, 7-2
- International ISDN Video Calls (setting) 2-41
- interoperability issues, resolving 12-2
- inverse multiplexer, *See* BRI network interface
- IP address
  - default gateway 2-3
  - displaying 7-5
  - DNS server 2-4
  - entering manually 2-3
  - gatekeeper 2-10
  - Global Directory Server 6-11
  - obtaining 2-3
  - primary gatekeeper 2-10
  - SNMP network management workstation 9-8
- IP Address (IPv4) (setting) 2-3
- IP Address (IPv6) (setting) 2-4
- IP Address (setting) 2-3
- IP calls, enabling 2-37
- IP Gateway (setting) 2-38
- IP network, configuring 2-8-2-24
- IP precedence 2-21
- IPv4 configuration 2-3
- IPv6 configuration 2-4
- IR sensors, connecting to the system 10-5
- ISDN
  - BRI, configuring 2-29
  - calls, enabling 2-30, 2-31

- channels dialed in parallel 2-30, 2-32
  - dialing prefix for outside line 2-31
  - enabling 2-39
  - line signaling protocol 2-31
  - network hardware requirements 2-26
  - numbers, displaying 7-5
  - PRI, activating/deactivating channels 2-33
  - PRI, configuring 2-31, 2-33
  - restore PRI defaults 2-32
  - SPIDs 2-30, 2-31
  - switch protocol 2-31, 2-32
  - voice-only calls, enabling 2-39
- ISDN (screen)
- BRI network interface 2-29
  - PRI network interface 2-31
- ISDN Gateway (setting) 2-38
- ISDN Switch Protocol (setting) 2-30
- ISDN Video Calls (H.320) (setting) 2-41
- ISDN Voice Algorithm (setting) 2-30, 2-32
- J**
- jitter (call statistics) 11-4
- K**
- keep-alive setting 2-24
- keyboard noise reduction 4-15
- Keypad Audio Confirmation (setting) 10-2
- kiosk mode 7-3
- L**
- LAN
- and Polycom Touch Control 1-15
  - configuring 2-3
  - connector A-10
  - port 2-6
  - status lights 2-2
- LAN Properties (screen) 2-3, 2-4
- LAN Speed (setting) 2-5
- Language (setting) 7-2
- Last Number Dialed (setting) 7-6
- LDAP 6-9, 6-11, 9-8
- LDAP screen 6-11
- LDAP, favorites
- by Polycom CMA or RealPresence Resource Manager System 6-15
  - H.350 or Active Directory 6-14
- Level (setting) 4-16, 4-17
- lighting
- backlight compensation 3-29
  - issues with an EagleEye Director 3-33
- lights
- BRI network interface 2-28
  - HDX 4000 systems power 1-12, 1-13
  - HDX 4500 system power 1-14, 1-15
  - HDX 8000/7000/6000 series power 1-11
  - HDX 9000 series power 1-10
  - LAN status 2-2
  - microphone 4-9
  - power 1-16
  - PRI network interface 2-28
  - serial V.35/RS-449/RS-530 network interface 2-29
- limitations with security mode 8-9
- limiting the ICMP transmission rate 2-6
- Line Build Out (setting) 2-32
- Line In Level (dB meter) 4-18
- Line Out (dB meter) 4-17
- Line Out Level (dB meter) 4-18
- Line Output Mode (setting) 4-17
- Line Signaling (setting) 2-31
- Line Termination (read-only setting) 2-33
- Link-Local (setting) 2-4
- list of sessions logged in to your system 11-8
- Local Date and Time (setting) 7-5
- local interface port lockout 8-38
- Localized Name (setting) 6-8
- Localized System Name (setting) 6-6
- Location (screen) 2-30, 7-1
- Location Name (setting) 9-8
- location settings 7-2
- Lock Account after Failed Logins (setting) 8-37, 8-38
- Lock Port after Failed Logins (setting) 8-39
- Log Level (setting) 11-14
- Log Management screen 8-42
- logging 8-41, 8-42
- login 8-4, 8-37, 8-38, 8-39
- logo, screen saver 7-8
- logs
- EagleEye Director 11-14
  - system 11-13
- long distance dialing 7-1
- low security profile, using 8-17
- M**
- Mailbox (Primary SMTP) 6-17
- Management Servers (screen) 9-5
- managing certificates 8-27

- managing remote access 8-34
- manual
  - call answering 6-3
  - enter IP address 2-4
  - power off EagleEye Director 3-31
  - preferred dialing method 2-39, 2-42
  - set white balance 5-8
- Marquee 7-7
- Marquee (setting) 7-4
- marquee text 7-6
- Master Audio Volume (setting) 4-18
- maximum
  - call duration 6-1
  - content resolution 5-4
  - frame rate, content 5-1, C-5
  - resolutions
    - 1080p systems on HDX 6000 C-10
    - 720p systems on HDX 7000 C-9
  - using security profile 8-11
- Maximum Consecutive Repeated Characters (setting) 8-26
- Maximum Number of Active Web Sessions (setting) 8-34
- Maximum Number of Sessions Per User (setting) 8-34
- Maximum Password Age in Days (setting) 8-26
- Maximum Peer Certificate Chain Depth (setting) 8-28
- Maximum Receive Bandwidth (setting) 2-22
- Maximum Resolution C-9, C-10
- Maximum Resolution (setting) 2-39
- Maximum Speed for Receiving Calls (setting) 2-41
- Maximum Time in Call (setting) 6-1
- Maximum Transmission Unit Size (setting) 2-21
- Maximum Transmit Bandwidth (setting) 2-22
- media over TCP 2-24
- medium security profile, using 8-14
- meeting password 8-3
- messages
  - destination unreachable 2-6
  - redirect 2-6
  - sending to call participants 9-4
- meters, audio 4-16, 4-17, 4-18, 4-20
- MIBs, downloading, downloading MIBs 9-7
- microphones
  - configuring for stereo 4-20
  - configuring non-Polycom 4-22
  - configuring Polycom 4-15
  - connecting 4-9
  - EagleEye View 4-3
  - enabling 4-15
  - lights 4-9
  - monaural operation 4-3
  - placement for stereo 4-8
  - positioning 4-3
  - positioning for stereo 4-12
  - stereo operation 4-3
  - supported cable configurations 4-5, 4-6, 4-7
  - swapping right and left 4-20
- Microsoft 2-18, 6-9, 6-10
- Microsoft Exchange Server Address (setting) 6-16
- Microsoft Lync Server 2010 2-18, 2-19
- Microsoft Lync Server 2010 (setting) 2-18
- Microsoft Office Communications Server
  - integration with Polycom HDX systems 2-18
- Microsoft Office Communications Server 2007 R2 6-9, 6-10
- Microsoft Outlook, conferencing 6-15
- Microsoft, favorites 6-15
- Minimum Changed Characters (setting) 8-26
- Minimum Length (setting) 8-25
- Minimum Password Age in Days (setting) 8-26
- minimum security profile, using 8-20
- mixed calls, allowing 6-2
- mixer, *See* Vortex mixer
- modem
  - configuring for closed captions 10-5
  - dial-up connection 5-10
- Monitor 1 (setting) 3-4, 3-8
- Monitor 2 (setting) 3-6
- Monitor 3 (setting) 3-7
- Monitor 3 (VCR/DVD) (setting) 3-7
- Monitor 4 (setting) 3-8
- monitors
  - aspect ratio, specifying 3-4, 3-6, 3-7, 3-8
  - brightness adjustment 3-12
  - burn-in prevention 3-13
  - color balance adjustment 3-13
  - configuring 3-3, 3-13
  - configuring for dual monitor emulation 3-9
  - connecting 3-1, 3-2, 3-3
  - output formats 3-1, 3-2, 3-3
  - screen saver output 3-4, 3-6, 3-8
  - sharpness setting 3-12
  - specifying what to display 3-7, 3-8
  - using for PC 1-3
  - video format, specifying 3-4, 3-6, 3-7, 3-8
- Monitors (screen) 3-4

- Motion (setting) 3-24, 3-25, 3-26, 3-27, 3-28
  - mounting brackets, installing 1-4
  - multipoint calls
    - cascaded 6-4, 6-5
    - configuring 3-11
    - display mode 3-11
    - HD and SD 3-12, 3-38
    - option key 6-3
    - trial mode 6-4
    - using PathNavigator 2-11, 2-12, 6-4
  - Multipoint Mode (setting) 3-11
  - MusicMode 4-15
  - Mute Auto-Answer Calls (setting) 4-14
  - mutual TLS support 2-26
  - My Extension(setting) 7-5
  - My Information (screen) 9-6
  - My IP (setting) 7-5
  - My ISDN (setting) 7-5
  - My SIP (setting) 7-5
- N**
- name
    - camera 3-24, 3-25, 3-26, 3-27, 3-28, 7-7
    - common (CSR) 8-30
    - directory settings 6-6
    - DNS, system 2-4
    - H.323 2-9, 2-10
    - host 2-4
    - system
      - creating localized 6-7
      - displaying 7-5
      - in Simplified Chinese 6-6
      - setting 6-6
  - Name (setting) 3-24, 3-25, 3-26, 3-27, 3-28
  - NAT
    - configuring 2-22, 2-23, 2-24
    - Public (WAN) Address (setting) 2-23
    - UPnP certified 2-23
  - NAT Configuration (setting) 2-23
  - NAT is H.323 Compatible (setting) 2-24
  - Near End Loop test 11-5
  - network
    - configuring using the setup wizard 1-17
    - connectors A-10
    - hardware requirements 2-26
    - HD readiness services 2-1
    - inputs and outputs A-10
    - IP, configuring 2-8-2-24
    - preparing 2-1
  - Network Address Translation, *See* NAT
  - network interfaces
    - BRI
      - capabilities 2-26
      - configuring 2-29
      - lights 2-28
      - requirements 2-26
    - connecting 2-27
    - PRI
      - capabilities 2-26
      - configuring 2-31
      - lights 2-28
      - requirements 2-26
    - serial V.35/RS-449/RS-530
      - capabilities 2-26
      - configuring 2-39
      - lights 2-29
      - requirements 2-27
  - network limitation for Global Management System 2-11
  - Network Mode (read-only setting) 2-33
  - NIDS setting 2-18
  - non-Polycom audio meters 4-22
  - notes about security settings 8-10
  - NTLM Version (setting) 8-6
  - null modem adapter 5-11
  - Number (setting), gateway 2-14
  - Number + Extension (setting) 2-14
  - Number of Active Channels (read-only setting) 2-33
  - Number of Digits in DID Number (setting) 2-14
  - Number of Digits in Extension (setting) 2-14
  - Number of ISDN Channels to Dial in Parallel (setting) 2-30, 2-32
  - Numbering Plan (setting) 2-30, 2-32
  - Numeric Keypad Function (setting) 10-2
- O**
- Obtain IP Address Automatically (setting) 2-3
  - online certificate status protocol (OCSP)
    - configuring 8-32
    - definition of responder 8-31
  - on-screen instructions, providing 7-6, 7-8, 9-4
  - option key, multipoint 6-3
  - options
    - 1080p resolution 1-2, 3-14, 3-15, C-5, C-7, C-8, C-10
    - key codes 9-11, 12-5
    - multipoint calling 6-3
    - multipoint trial mode 6-4
  - Options (screen) 6-3, 6-4
  - Organization (O) (setting) 8-30

- Organizational Unit (OU) (setting) 8-30
- output formats
  - audio, connecting 4-11-4-12
  - video 3-1, 3-2, 3-3
- Output upon Screen Saver Activation (setting) 3-4, 3-6, 3-8
- outputs
  - audio A-6
  - network A-10
  - video A-1
- Outside Line Dialing Prefix (setting) 2-30, 2-31, 2-36

## P

- packet loss (call statistics) 2-20, 11-4
- pairing the Polycom Touch Control 10-8
- Parity (setting) 10-5
- Password (setting) 2-5, 6-12, 6-16, 9-11
- Password Expiration Warning in Days (setting) 8-26
- passwords
  - for closed captioning 5-12
  - Global Directory 6-11
  - length 8-25
  - meeting, setting 8-3
  - password-protected screens 8-1
  - policies 8-25
  - provisioning service 9-11
  - remote access, setting and deleting 8-4
  - room, default 1-17
  - room, setting and deleting 1-17, 8-3, 8-27
  - Security Mode requirements 8-9
  - SIP authentication 2-18
- PathNavigator, using for multipoint calls 2-11, 2-12, 6-4
- PC LAN port 2-6
- People on Content
  - configuring 5-7
  - HDX systems to use 5-6
  - manually setting white balance 5-8
  - room setup 5-6
  - with EagleEye Director 5-6
- People Video Adjustment (setting) 3-9
- People video source 3-25, 3-26, 3-27, 3-28
- People+Content
  - cascaded calls 6-5
  - enabling for H.331 broadcasting 2-35
  - enabling H.239 2-37
- People+Content IP
  - background content 5-7
  - configuring 5-5

- LAN ports A-10
  - using LAN 2-1
  - using with Polycom Touch Control 5-6
- Percent Filled Threshold (setting) 8-42
- Phase (setting) 3-28
- phone connector A-10
- Phone Dialing Order (setting) 2-40
- phone line, connecting 2-35
- picture-in-picture, *See* PIP
- PING test 11-5
- PIP 3-5
- Place a Call (screen), *See* home screen
- Place a Call button 7-4
- placing
  - cascaded calls 6-5
  - microphones for sending stereo 4-8
  - speakers to play stereo 4-12
  - test calls 12-1
- plasma monitors, preventing burn-in 3-13
- Play Reminder Tone (setting) 6-17
- Polycom Annotation RS-232 mode 10-5
- Polycom Conferencing for Microsoft Outlook 6-15
- Polycom GDS 6-9
- Polycom GDS, favorites 6-14
- Polycom Microphone Type (dB meter) 4-19
- Polycom Touch Control
  - account number restriction 9-5
  - pairing 10-8
  - positioning 1-6
  - power 1-15
  - setting up 10-6
  - unpair 10-9
  - USB content 5-1
- Port Lock Duration in Minutes (setting) 8-39
- port lockout 8-38
- port usage B-1
- ports
  - fixed, specifying 2-23
  - serial V.35/RS-449/RS-530 2-33
  - TCP and UDP, specifying 2-23
- positioning
  - EagleEye Director 1-7
  - HDX 4000 series system 1-6
  - HDX 8000 series, HDX 7000 series, or HDX 6000 series system 1-5
  - HDX 9000 series system 1-4
  - Polycom Touch Control 1-6
  - speakers, for stereo 4-13
- POTS, *See* analog phone

- power
    - connector A-10
    - HDX 4000 systems indicator light 1-12, 1-13
    - HDX 4500 system indicator light 1-14, 1-15
    - HDX 8000/7000/6000 series indicator light 1-11
    - HDX 9000 series indicator light 1-10
    - indicator light 1-16
    - switch 1-9, 1-10, 1-11, 1-12, 1-13, 1-14
  - Power Frequency (setting) 3-29
  - Preferred Dialing Method (setting) 2-39
  - Preferred Speed for Placing Calls (setting) 2-40
  - prefix, gateway 2-15
  - presence states 6-14
  - Presentation mode (multipoint display) 3-11
  - presets, *See* camera presets
  - Preview Directory Entry Information (setting) 6-6
  - PRI dialing speeds C-2
  - PRI Line Type (read-only setting) 2-33
  - PRI network interface
    - activating/deactivating channels 2-33
    - capabilities 2-26
    - configuring 2-33
    - configuring ISDN 2-31
    - connecting to systems 2-26
    - hardware requirements 2-26
    - lights 2-28
    - line signaling formats 2-31
    - restore defaults 2-32
  - PRI Video Number (setting) 2-31
  - Primary Camera (setting) 3-29
  - Primary Gatekeeper IP Address (setting) 2-10
  - profiles
    - calling 2-34
    - managing with Polycom HDX web interface 9-3
    - security 8-3
    - settings that are included 9-3
    - storing on a computer 9-3
    - uploading from a computer 9-3
  - protocol
    - ISDN line signaling 2-31
    - ISDN switch 2-30, 2-31, 2-32
  - provisioning automatically 9-10
  - Provisioning Service 9-8, 9-9, 9-10
  - Proxy Server (setting) 2-17
  - Pulse Width (setting) 2-35
  - PVEC (Polycom Video Error Concealment) 2-20, 2-21
- Q**
- quality
    - calls 2-40, 2-41
    - degraded in diagnostic mode 12-2
    - people and content 3-29
    - picture 11-6
    - video 3-24
  - Quality of Service 2-20
  - Quality of Service (screen) 2-21, 2-22
  - Quality Preference (setting) 3-29
- R**
- rack mounting brackets, installing 1-4
  - Read-Only Community (setting) 9-8
  - rear panel views A-1, A-6
  - Recent Calls
    - button 7-5
    - button on home screen 6-2
    - calls not listed 11-9
    - list 6-2, 11-9
    - See also* Call Detail Report (CDR)
  - recording calls
    - configuring audio 5-3
    - configuring video 5-3
    - configuring video source 3-7
    - setting volume 4-18
    - VCR/DVD 5-2
    - while playing a VCR/DVD 4-18
  - redirect messages 2-6
  - reference audio signal, EagleEye Director 11-6
  - refusing calls 6-3, 7-5
  - Register with Calendaring Service (setting) 6-16
  - registering with Global Directory Server 6-11
  - Registrar Server (setting) 2-16
  - Registration Status (setting) 6-12
  - Reminder Time in Minutes (setting) 6-17
  - remote access
    - admin password 8-2, 8-4
    - admin room password 8-3
    - banner text 8-6
    - enabling 8-4
    - limiting 8-3
    - managing 8-34
    - port lockout 8-39
    - user password 8-4
    - user room password 8-4
    - using room passwords 8-3
  - Remote Access Password (setting) 8-4
  - remote control
    - channel ID 10-3
    - configuring 10-1

- controlling a recording device 10-3
  - delete sample sites 12-1
  - keypad audio confirmation 10-2
  - programming codes D-1
  - Remote Control (screen) 10-1, 10-3
  - Remote Log Server (setting) 11-14
  - Remote Logging Enabled (setting) 11-14
  - remote management 1-17, 8-4
  - removing sample sites 12-1
  - Require Login for System Access (setting) 8-4
  - Require Lowercase Letters (setting) 8-25
  - Require Numbers (setting) 8-25
  - Require Special Characters (setting) 8-26
  - Require Uppercase Letters (setting) 8-25
  - requirements
    - browser, for Polycom HDX web interface 9-1
    - for People+Content IP 5-5
    - for using PathNavigator Conference On Demand 2-12
    - hardware, for BRI network 2-26
    - hardware, for PRI network 2-26
    - hardware, for serial V.35/RS-449/RS-530 network 2-26
    - HD multipoint calls 3-39
    - resolution and frame rates for content video C-11
    - SD multipoint calls 3-39
  - requiring account number for call 9-5
  - Reset System (setting) 11-8
  - resetting
    - EagleEye Director 12-7
    - HDX system 12-2
    - Polycom Touch Control 12-6
    - system defaults 11-8
  - Resolution (setting) 3-4, 3-6, 3-8
  - resolutions
    - 1080p systems (NTSC) C-6
    - 720p systems (NTSC) C-5
    - H.264 high profile C-7
    - maximum 1080p systems on HDX 7000 C-10
    - maximum 720p systems on HDX 7000 C-9
    - SD systems (NTSC) C-4
    - VGA, for People+Content IP 5-5
  - Respond to Broadcast and Multicast Echo Requests (setting) 2-7
  - Restart System (setting) 11-8
  - restarting system
    - diagnostics 11-8
    - settings that cause 2-3-2-6, 3-29, 7-2, 8-4, 8-5
  - restore button
    - EagleEye Director 12-7
    - HDX system 12-2
    - Polycom Touch Control 12-6
  - Restore Defaults (setting) 2-32
  - restrictions for cascaded calls 6-5
  - Revocation Method (setting) 8-31, 8-32
  - ring tones, setting 4-14
  - roles 8-34
  - room monitoring
    - enabling 8-5, 9-2
    - viewing a room or call 9-2
  - room password
    - admin 8-3
    - default 1-17
    - screens that require 8-1
    - setting and deleting 1-17, 8-3, 8-27
    - user 8-4
  - Room Telephone Number (setting) 2-36
  - RS-232 Flow Control (setting) 10-6
  - RS-232 Mode (setting) 10-5
  - RS-232 serial port
    - configuring for a Vortex mixer 4-22
    - configuring for closed captions 5-10, 5-11
    - connectors A-10
    - data pass-through 10-5
    - disable 10-5
    - equipment used with 10-4
  - RS-366 Dialing (setting) 2-34
  - RS-449, *See* serial V.35/RS-449/RS-530
  - RS-530, *See* serial V.35/RS-449/RS-530
  - RSVP (Resource Reservation Setup Protocol) 2-21
  - RT signal polarity 2-34
  - RTS signal polarity 2-34
- S**
- sample sites, deleting 12-1
  - Save Global Directory to System (setting) 6-11
  - screen saver 7-8
  - screen saver output
    - monitor 1 3-4
    - monitor 2 3-6
    - monitor 3 3-8
    - monitor 4 3-8
  - Screen Saver Wait Time (setting) 3-9
  - SD multipoint 3-12
  - SD multipoint calls 3-39
  - SD system (NTSC) resolutions C-4
  - Search (setting) 6-7
  - search button 6-7



- security
  - allowing mixed calls 6-2
  - controlling remote access 8-4, 9-2
  - profiles 8-3
  - room monitoring 9-2
  - selections 8-10
  - System screen access 7-5
  - systems outside firewalls 2-24
- Security (screen) 8-2, 9-2
- security mode 8-10
- Security Mode (setting) 8-3
- Security Profile (setting) 8-8
- Send a Message (screen, web interface) 9-4
- Send Content When PC Connects (setting) 3-30
- sensor, IR 10-5
- serial connectors A-10
- serial dialing 2-32
- Serial Port (screen) 5-10, 5-11, 10-5
- serial port lockout 8-39
- serial port, *See* RS-232 serial port
- serial V.35/RS-449/RS-530 network interface
  - call speed 2-34
  - calling profile 2-34
  - configuring signal polarity 2-34
  - connecting 2-26, 2-27
  - crypto resync pulse 2-35
  - enabling 2-39
  - hardware requirements 2-26
  - lights 2-29
- Server Address (setting)
  - LDAP 6-11
- Server name or IP address (setting) 2-16
- Server Port (setting) 6-11
- Server Status (screen) 11-3
- sessions
  - enabling the sessions list 8-6
  - list of 11-8
- setting camera presets 3-35
- setting up
  - Polycom Touch Control 10-6
  - room for People on Content 5-6
- setup wizard 1-17, 9-9
- sharing content
  - configuring display 5-4
  - enabling H.239 2-37
  - using People+Content IP 5-5
- Sharpness (setting) 3-24, 3-25, 3-26, 3-27, 3-28
- Show My Offline Contacts (setting) 6-13
- Show Private Meeting Information (setting) 6-17
- signal polarity 2-34
- Sign-in Address (setting) 2-17
- SIP
  - address
    - displaying 7-5
  - configuring 2-15
  - enabling 2-37
  - password 2-18
  - restrictions 2-18
- SIP Server Configuration (setting) 2-16
- Site-Local (setting) 2-4
- siting considerations 1-4, 1-5, 4-3
- SNMP
  - access, controlling 8-4
  - conditions reported 9-6
  - configuring 9-7
  - downloading and installing MIB 9-7
  - downloading MIBs 9-7
- SNMP (screen) 9-7
- software, updating 9-11
- solution support 12-8
- Sound Effects Volume (setting) 4-14
- Source (setting) 3-25, 3-26, 3-27, 3-28
- Speaker Test 4-13
- speakers
  - connecting 4-10
  - positioning for stereo 4-12, 4-13
  - testing 11-7
  - volume 4-13
- Specify with PIN (gatekeeper setting) 2-10
- Speed (setting) 2-34
- Speed Dial 7-5, 7-6
- speeds
  - BRI dialing C-3
  - multipoint call C-1
  - point-to-point call C-1
  - PRI dialing C-2
- SPIDs 2-31
- ST signal polarity 2-34
- start EagleEye Director camera tracking 3-32
- Start Log Transfer 8-43
- State or Province (ST) (setting) 8-30
- statistics
  - call 11-3
  - content 11-4
- Stereo (setting) 4-20
- StereoSurround
  - adjusting volume 4-21
  - autorotation setting 4-20
  - enabling 4-19
  - kit 4-12

- positioning microphones 4-12
  - positioning speakers 4-12, 4-13
  - room layouts 4-8
  - stereo setting 4-20
  - swapping microphones 4-20
  - testing 4-20
  - Stop Bits (setting) 10-5
  - stop EagleEye Director camera tracking 3-32
  - Storage Type (setting) 8-42
  - Subnet Mask (setting) 2-3
  - subwoofer, positioning 4-13
  - suffix, gateway 2-15
  - Switch Protocol (setting) 2-32
  - switch protocol, ISDN 2-30, 2-31
  - system
    - configuration, initial 1-17
    - name
      - creating localized 6-7
      - displaying 7-5
      - displaying in Simplified Chinese 6-6
      - H.323 2-9, 2-10
      - setting 6-6
      - positioning 1-4-1-6
      - types of HDX 1-1-1-3
  - System (setting) 7-5
  - System Description (setting) 9-8
  - System Log Settings 11-14
  - system logs, downloading 11-13
  - System Name (setting) 6-6, 7-5
  - System Phone Number (setting) 2-36
  - system profiles
    - managing with Polycom HDX web interface 9-3
    - settings that are included 9-3
    - storing on a computer 9-3
    - uploading from a computer 9-3
  - System screen, allowing access 7-5
  - System Status (screen) 11-2
- T**
- TCP Ports (setting) 2-23
  - TCP, media over 2-24
  - technical support
    - contacting 12-8
    - from GMS administrator 9-6
    - web page address 12-8
  - Telephony (screen) 2-36
  - telephony, configuring 2-36
  - Telnet
    - access, controlling 8-4
    - using in Security Mode 8-10
  - Terminal Endpoint ID (read-only setting) 2-33
  - test calls
    - placing 12-1
    - stereo 4-21
  - test calls, stereo 4-21
  - testing microphones for EagleEye Director 11-6
  - tests
    - audio meter 11-7
    - color bar 3-13, 11-6
    - speaker 11-7
  - text in screen saver 7-8
  - time
    - daylight saving 7-2
    - displaying 7-5
    - elapsed, displaying 6-1, 7-2
    - setting 7-1
    - to display far site name 6-2
  - Time Between Pulses (setting) 2-35
  - Time Format (setting) 7-2
  - Time Server (setting) 7-2
  - Time Server Address (setting) 7-2
  - Time Zone (setting) 7-2
  - timeout 6-1
  - time-out, screen saver 3-9
  - tones
    - alert 4-14
    - DTMF 10-2
    - ring 4-14
    - touch 10-2
  - touch tones 10-2
  - touch-panel control, AMX or Crestron
    - configuring 10-5
    - connecting 10-4
  - Trace Route test 11-5
  - tracking calls 9-5
  - tracking, EagleEye Director 3-32
  - Transcoding
    - (setting) 2-38
    - video resolution 2-38
  - Transfer Frequency (setting) 8-42
  - transferring logs 8-42
  - transmission rate, ICMP 2-6
  - transmit and receive, HD calls 3-38
  - Transport Protocol (setting) 2-17
  - Trap Version (setting) 9-8
  - treble adjustment 4-18
  - troubleshooting test calls 12-2
  - Type (setting) 8-30

Type of Service (setting) 2-21  
 Type of Service Value (setting) 2-21

## U

UC Board 5-8  
 UDP Ports (setting) 2-23  
 unpairing the Polycom Touch Control 10-9  
 updating software 9-11  
 USB content, Polycom Touch Control 5-1  
 Use Gatekeeper (setting) 2-10  
 Use Non-Polycom Remote (setting) 10-2  
 Use PathNavigator for Multipoint Calls (setting) 2-11  
 Use Responder Specified in Certificate (setting) 8-32  
 Use Room Password for Remote Access (setting) 8-3  
 Use RTS Signal for Resync Pulse (setting) 2-35  
 Use SSL (Secure Socket Layer) 6-12  
 User Account screen 8-37  
 User Alert Tones (setting) 4-14  
 User ID (setting) 8-4  
 User Name (setting)  
   Calendaring Service 6-16  
   LDAP 6-12  
   Microsoft Office Communications Server 6-13  
   provisioning service 9-11  
 User Name (SIP setting) 2-17  
 User Password (setting) 8-4  
 User Remote Access Password (setting) 8-4  
 user role 8-34  
 user settings  
   allowing access 8-5  
   backlight compensation 3-29  
   camera presets 3-36  
   disable user account 8-35  
   far control of near camera 3-28  
   list 8-40  
   muting auto-answer calls 4-14  
   PIP 3-5  
 User Settings (screen) 8-5, 8-40  
 using  
   low security profile 8-17  
   maximum security profile 8-11  
   medium security profile 8-14  
   minimum security profile 8-20  
   security mode with Global Management System 8-9  
   voice tracking with EagleEye Director 3-33  
 utilities

Call Detail Report 11-10, 11-13  
 Import Directory 6-8  
 Web Director (room monitoring) 9-2

## V

V.35 Ports Used (setting) 2-33  
 V.35/RS-449/RS-530 (screen) 2-33  
 V.35/RS-449/RS-530 (setting) 2-39  
 V.35/RS-449/RS-530 Serial Status (screen) 11-5  
 V.35/RS-449/RS-530, *See also* serial V.35/RS-449/RS-530  
 validating account numbers 9-5  
 validating certificates 8-30  
 VBP firewall traversal 2-25  
 VCR/DVD  
   configuring audio 5-2, 5-3  
   configuring video 5-3  
   connecting 5-2  
   controlling with remote control 10-3  
   playing videotapes in calls 5-2  
   recording calls 5-2  
 VCR/DVD Audio Out Always On (setting) 4-18  
 VCR/DVD In Level (setting) 4-17  
 VCR/DVD Out Level (setting) 4-18  
 VCR/DVD Record Source (setting) 3-7  
 Vertical Position (setting) 3-28  
 VGA Input settings 3-28  
 VGA resolution for People+Content IP 5-5  
 video  
   brightness adjustment 3-12  
   color balance adjustment 3-13  
   error concealment 2-21  
   format, monitors 3-4-3-8  
   input formats 3-17, 3-19, 3-20, 3-21, 3-22, 3-23  
   inputs A-1  
   Motion setting 3-24, 3-25, 3-26, 3-27, 3-28  
   output formats 3-1, 3-2, 3-3  
   outputs A-1  
   protocol (call statistics) 11-4  
   sharpness adjustment 3-12  
   sharpness setting 3-24, 3-25, 3-26, 3-27, 3-28  
   sources, connecting 3-17, 3-20, 3-21  
   specifying bandwidth for People and Content 3-29  
   specifying what monitors display 3-7, 3-8  
   VCR/DVD settings 5-3  
 Video Diagnostics (screen) 11-6  
 Video Dialing Order (setting) 2-40  
 Video Format (setting)  
   for broadcasting 2-35

- Monitor 1 3-4, 3-8
- Monitor 2 3-6
- Monitor 3 3-7
- Video Priority (setting) 2-5
- Video Protocol (setting), for broadcasting 2-35
- Video Quality (setting) 3-24, 3-25, 3-26, 3-27, 3-28
- video sources, connecting 3-19, 3-22, 3-23
- VLAN ID (setting) 2-5
- voice algorithm for ISDN 2-30, 2-32
- Voice Over ISDN (setting) 2-39
- voice-activated switching mode (multipoint display) 3-11
- voice-only calls, enabling 2-38, 2-39
- volume
  - audio line in 4-16
  - bass 4-18
  - for recording calls 4-18
  - master control 4-18
  - ring tones 4-14
  - sound effects 4-14
  - speakers 4-13
  - treble 4-18
- VCR/DVD playback 4-17
- Vortex mixer
  - compatibility with echo cancellation 4-16
  - configuring 4-21, 10-5
- VPN, configuring 2-23

## W

- waking up the EagleEye Director 3-25
- Web Access Port (setting) 8-5
- web access, controlling 8-4
- web browser
  - configuring to use Polycom HDX web interface 9-1
- Web Director 8-5, 9-2
- web interface
  - accessing 9-2
  - accessing in Security Mode 8-10
  - Call Detail Report, downloading 11-10
  - Call Detail Report, downloading archives 11-13
  - configuring browser 9-1
  - managing directories 6-8
  - managing system profiles 9-3
  - providing closed captions 5-12
  - room monitoring 8-5, 9-2
  - sending messages to call participants 9-4
  - system log, downloading 11-13
- web interface port lockout 8-39
- white balance
  - configuring 3-34
  - People on Content 5-8
- whitelist, enabling 8-33
- wide-screen monitors, configuring 3-4, 3-6, 3-7, 3-8, 3-9